

## Piezo valves VEMP

**FESTO**



## Key features



### Innovative

- Piezo technology
- Very low power consumption
- High precision

### Versatile

- When combined with pressure sensor and control electronics it can be used as a proportional pressure regulator
- When combined with a flow sensor and control electronics it can be used as a proportional flow control valve

### Reliable

- No self-heating
- Long service life

### Easy to mount

- Can be mounted on a terminal strip
- Small installation space
- Light weight

## Key features

### Mode of operation

#### Description

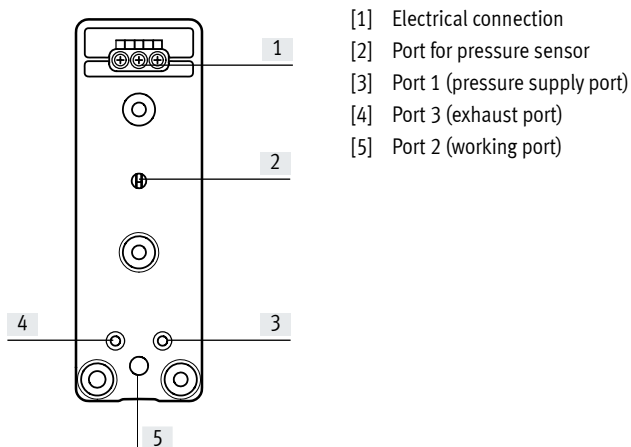

The VEMP is a proportional 3/3-way valve in which a split piezo actuator (piezo actuator 1 and 2) is controlled electrically. The valve also has a connection for a pressure sensor.

When combined with a pressure sensor and control electronics, the 3/3-way proportional valve can be used as a proportional pressure regulator.

Alternatively, the flow can also be controlled using a closed loop circuit by integrating a flow sensor in the output line (operation as 2/2-way valve).

In the normal position, the valve is closed. The working and pressure sensor ports are connected and always open, regardless of the switching status.

The two piezo actuators can only be actuated separately; if they are activated simultaneously, safe and reliable operation cannot be ensured.

### Control response

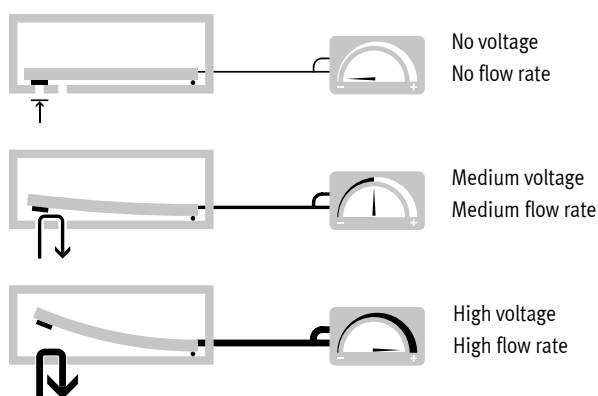

The piezo actuators are actuated using variable voltage to give proportional control.

The piezo valve VEMP exhibits the typical hysteresis behaviour of a proportional valve. Linear behaviour can be achieved by combining control electronics with a flow sensor.

This allows either the pressure or flow rate to be controlled, depending on the design.

The pressure or flow behaviour is controlled by integrating a sensor in the output line of the closed-loop control circuit.

### Operation as a proportional 3/3-way valve

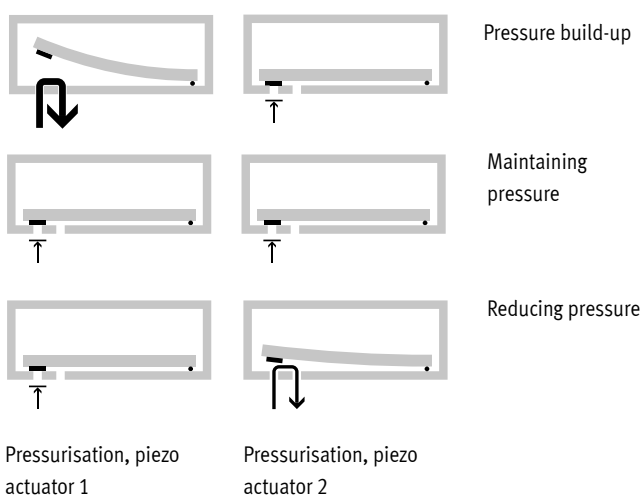

The piezo actuators installed in the valve VEMP proportionally regulate both the pressure and flow rate for pressurisation and ensure proportional exhausting.

**Exhausting:**  
 During exhausting, piezo actuator 2 opens, enabling flow from port 2 (working port) to port 3 (exhaust). At the same time, piezo actuator 1 closes port 1 (pressure supply port).

**Pressurisation:**  
 During pressurisation, piezo actuator 1 opens, enabling flow from port 1 (pressure supply port) to port 2 (working port). At the same time, piezo actuator 2 closes port 3 (exhaust).

## Key features

### Mode of operation

Operation as a proportional 2/2-way valve

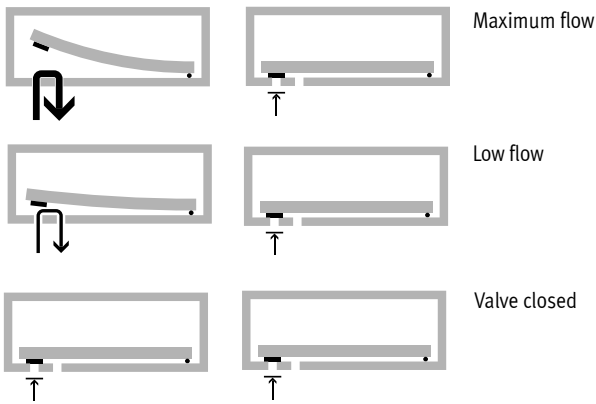

When used as a proportional 2/2-way valve, only piezo actuator 2 (exhaust) is switched; piezo actuator 1 (pressure supply port) must be electrically connected to earth (GND).

The flow behaviour is controlled by integrating a sensor in the supply or output line of the closed-loop control circuit.

Flow takes place from port 2 (working port) to port 3 (exhaust). When used as a 2/2-way valve, port 1 (pressure supply port) is not used, and must be closed.

Exhausting, piezo actuator 2 Exhausting, piezo actuator 1

### Low energy consumption

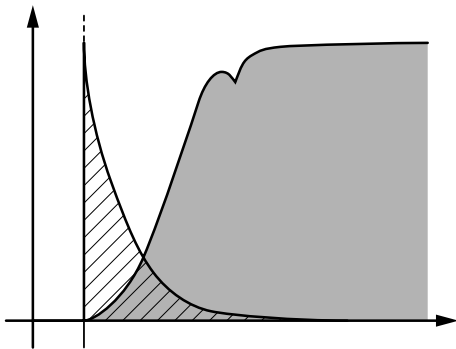

Compared with solenoid valves, proportional valves with piezo technology require virtually no energy to maintain an active state thanks to their capacitive principle. The piezo valve operates like a capacitor: it needs current only at the start in order to charge the piezoceramics.

No further energy is needed to maintain its state. The valves therefore generate no heat. They consume up to 95% less energy than solenoid valves, which permanently require an electrical current

## Peripherals overview

## Example: VEMP with sub-base

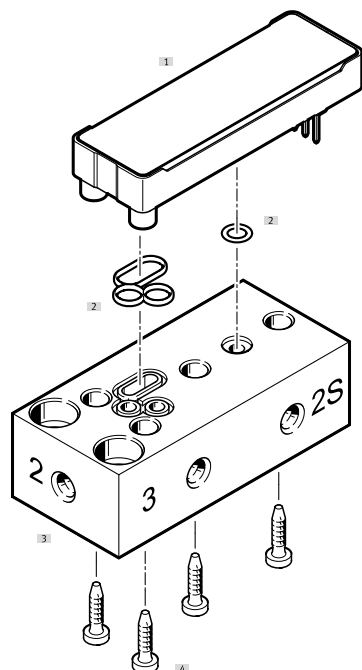

| Designation |                     | → Page/Internet |
|-------------|---------------------|-----------------|
| [1]         | Piezo valve VEMP    | 14              |
| [2]         | Assortment of seals | 14              |
| [3]         | Sub-base            | 14              |
| [4]         | Screw set           | 14              |

Product range overview

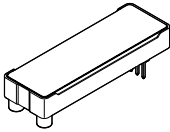
| Function       | Description   | Nominal width                              | Flow rate<br>[l/min] | Operating pressure<br>[bar] | Operating voltage |             |   |
|----------------|---|--|----------------------|-----------------------------|-------------------|-------------|---|
|                |   |  |                      |                             | 0 ... 310 V       | 0 ... 250 V |   |
| Sub-base valve |  | 3/3-way valve, normally closed, monostable |                      |                             |                   |             |   |
|                |   | Flange                                     | 1.3 mm               | 19/20                       | 0 ... 1.1         | –           | ■ |
|                |   | 3/3-way valve, normally closed, monostable |                      |                             |                   |             |   |
|                |   | Flange                                     | 1.3 mm               | 28/30                       | 0 ... 1.7         | ■           | – |
|                |   | 3/3-way valve, normally closed, monostable |                      |                             |                   |             |   |
|                |   | Flange                                     | 1.6 mm               | 18/19                       | 0 ... 0.7         | ■           | – |
|                |   | 3/3-way valve, normally closed, monostable |                      |                             |                   |             |   |
|                |   | Flange                                     | 1.6 mm               | 28/27                       | 0 ... 1.1         | ■           | – |

## Type codes

|      |                                |  |
|------|--------------------------------|--|
| 001  | Series                         |  |
| VEMP | Piezo valve                    |  |
| 002  | Directional control valve type |  |
| B    | Sub-base valve                 |  |
| 003  | Design principle               |  |
| S    | Bending actuator               |  |
| 004  | Valve function                 |  |
| 3    | 3/3-way valve, normally closed |  |
| 005  | Nominal width [mm]             |  |
| 1.3  | 1.3                            |  |
| 1.6  | 1.6                            |  |

|     |                           |  |
|-----|---------------------------|--|
| 006 | Pressure range [bar]      |  |
| D5  | 0 ... 0.5                 |  |
| D7  | 0 ... 1                   |  |
| D19 | 0 ... 1.7                 |  |
| 007 | Pneumatic connection      |  |
| F   | Flange/sub-base           |  |
| 008 | Nominal operating voltage |  |
| 22  | 250 V DC                  |  |
| 28  | 310 V DC                  |  |
| 009 | Electrical connection     |  |
| T1  | Pin                       |  |
| 010 | Package unit quantity     |  |
|     | Standard                  |  |
| P30 | 30                        |  |

## Data sheet

-  - Flow rate  
19 ... 29 l/min

-  - Voltage  
0 ... 250 V DC  
0 ... 310 V DC

-  - Operating pressure  
0 ... 1.7 bar



## General technical data

|                                  | VEMP-BS-3-13-D7-...              | VEMP-BS-3-13-D19-...                       | VEMP-BS-3-16-D5-...       | VEMP-BS-3-16-D7-...       |
|----------------------------------|----------------------------------|--|---------------------------|---------------------------|
| Valve function                   | 3/3-way valve, monostable        | 3/3-way valve or 2/2-way valve, monostable | 3/3-way valve, monostable | 3/3-way valve, monostable |
| Normal position                  | Closed                           |  |                           |                           |
| Standard nominal flow rate 1 → 2 | [l/min] 19                       | 28   | 18                        | 27                        |
| Standard nominal flow rate 2 → 3 | [l/min] 20                       | 29   | 19                        | 28                        |
| Dimensions W x L x H             | [mm] 17.2 x 52.1 x 7.2           |  |                           |                           |
| Nominal width                    | [mm] 1.3                         | 1.3  | 1.6                       | 1.6                       |
| Grid dimension                   | [mm] 17.2                        |  |                           |                           |
| Pneumatic connection 1, 2, 3     | Flange                           |  |                           |                           |
| Actuation type                   | Electrical                       |  |                           |                           |
| Type of mounting                 | On manifold rail                 |  |                           |                           |
| Mounting position                | Any                              |  |                           |                           |
| Flow direction                   | 1 → 2 and 2 → 3                  |  |                           |                           |
| Product weight                   | [g] 8                            |  |                           |                           |
| Special characteristics          | Oxygen-compatible to DIN EN 1797 |  |                           |                           |

## Electrical data

|                                   | VEMP-BS-3-13-D7-...             | VEMP-BS-3-13-D19-... | VEMP-BS-3-16-D5-... | VEMP-BS-3-16-D7-... |
|-----------------------------------|---------------------------------|----------------------|---------------------|---------------------|
| Nominal operating voltage         | [V DC] 250                      | 310                  | 310                 | 310                 |
| Operating voltage range           | [V DC] 0 ... 250                | 0 ... 310            | 0 ... 310           | 0 ... 310           |
| Max. electrical power consumption | [mW] 1                          |                      |                     |                     |
| Max. current consumption          | [mA] 5                          |                      |                     |                     |
| Max. switching frequency          | [Hz] 5                          |                      |                     |                     |
| Degree of protection              | Depending on the manifold block |                      |                     |                     |

1) If the charging current of 5 mA is exceeded, there is the risk of an ignition hazard for the piezo actuators both in an oxygen-enriched environment and in air.



## Data sheet

| Operating and environmental conditions |       | VEMP-BS-3-13-D7-...   | VEMP-BS-3-13-D19-... | VEMP-BS-3-16-D5-... | VEMP-BS-3-16-D7-... |
|--|-------|---|----------------------|---------------------|---------------------|
| Operating pressure                     | [bar] | 0 ... 1.1   | 0 ... 1.7            | 0 ... 0.7           | 0 ... 1.1           |
| Nominal operating pressure             | [bar] | 1   | 1.7                  | 0.5                 | 1                   |
| Operating medium                       |       | <ul style="list-style-type: none"> <li>• Inert gases</li> <li>• Air</li> <li>• Oxygen (oxygen applications to IEC 60601-1 only on request)</li> <li>• Nitrogen</li> </ul> |                      |                     |                     |
| Note on the operating/pilot medium     |       | Operation with lubricated medium not possible   |                      |                     |                     |
| Air quality                            | [µm]  | ≤ 5   |                      |                     |                     |
| Ambient temperature                    | [°C]  | -20 ... 70<br>0 ... 50 in operation as 2/2-way valve  |                      |                     |                     |
| Temperature of medium                  | [°C]  | -20 ... 60<br>0 ... 50 in operation as 2/2-way valve  |                      |                     |                     |
| Corrosion resistance class CRC         |       | 2 <sup>1)</sup>   |                      |                     |                     |

1) More information: [www.festo.com/x/topic/kbk](http://www.festo.com/x/topic/kbk)

| Safety characteristics                     |   |
|--|---|
| CE marking (see declaration of conformity) | To EU Low Voltage Directive <sup>1)</sup>                         |
| Shock resistance                           | Shock test with severity level 2, to EN 60068-2-27                |
| Vibration resistance                       | Transport application test with severity level 2, to EN 60068-2-6 |

1) More information: [www.festo.com/catalogue/...](http://www.festo.com/catalogue/...) → Support/Downloads.

| Materials         |                |
|-------------------|----------------|
| Seals             | EPDM           |
| Housing           | Reinforced PA  |
| Cover             | Reinforced PA  |
| Note on materials | RoHS-compliant |

## Design

## Circuit symbol

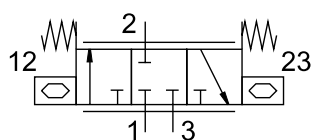

• 3/3-way valve, normally closed

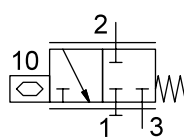

• 2/2-way valve, normally closed

## Note on risk assessment when used in medical equipment

The product has no redundancy and no error detection. Malfunctions must be detected by measures in the customer product if required.

| Pin allocation |     |              |
|----------------|-----|--------------|
|                | Pin | Function     |
|                | 1   | GND          |
|                | 2   | Pressurising |
|                | 3   | Exhausting   |

Data sheet

**VEMP-BS-3-13-D7-F-22T1, 1.3 mm nominal width**

Flow plotted against operating pressure at 250 V

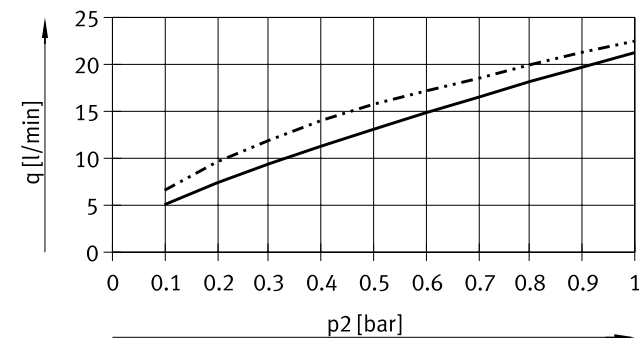

— Flow rate 1 → 2  
 - - - Flow rate 2 → 3

Flow plotted against voltage at room temperature, operating pressure 1 bar

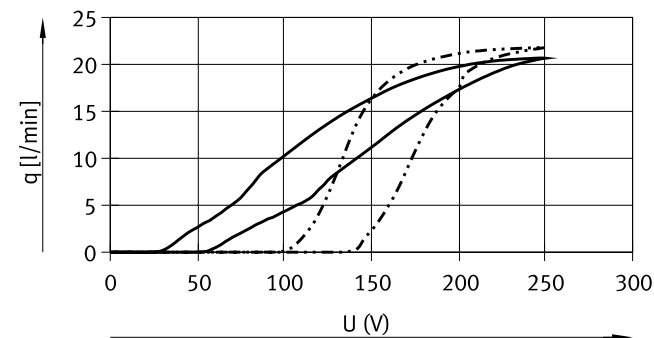

— Flow rate 1 → 2  
 - - - Flow rate 2 → 3

**VEMP-BS-3-13-D19-F-28T1, 1.3 mm nominal width**

Flow plotted against operating pressure at 310 V

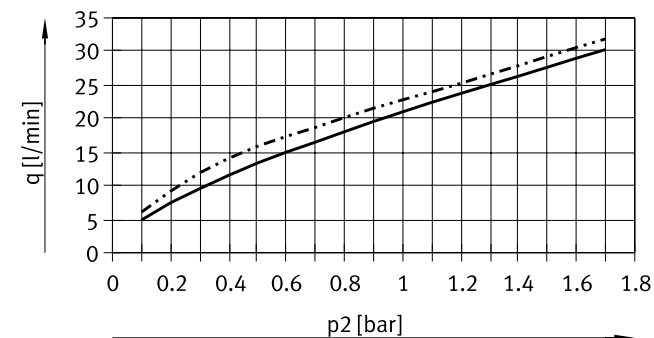

— Flow rate 1 → 2  
 - - - Flow rate 2 → 3

Flow plotted against voltage at room temperature, operating pressure 1.7 bar

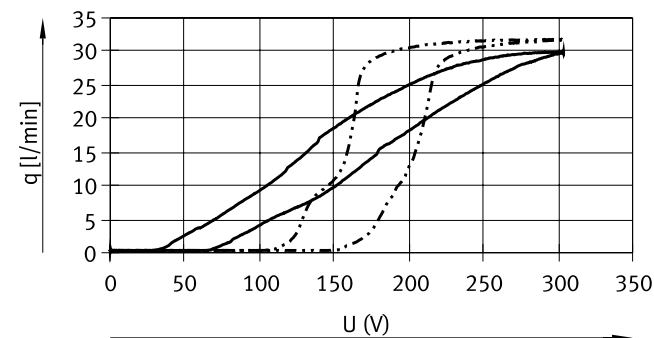

— Flow rate 1 → 2  
 - - - Flow rate 2 → 3

## Data sheet

**VEMP-BS-3-16-D5-F-28T1, 1.6 mm nominal width**

Flow plotted against operating pressure at 310 V

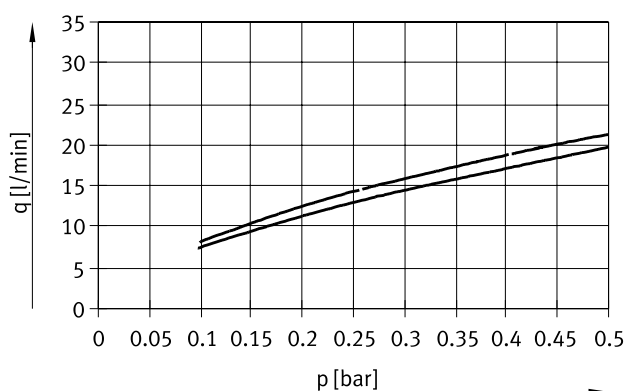

— Flow rate 1 → 2  
 - - - Flow rate 2 → 3

Flow plotted against voltage at room temperature, operating pressure 0.5 bar

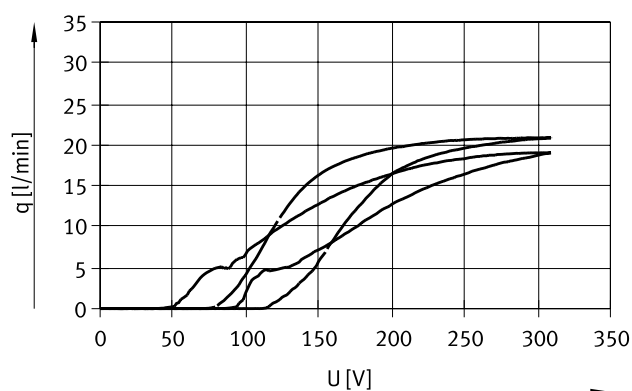

— Flow rate 1 → 2  
 - - - Flow rate 2 → 3

**VEMP-BS-3-16-D7-F-28T1, 1.6 mm nominal width**

Flow plotted against operating pressure at 310 V

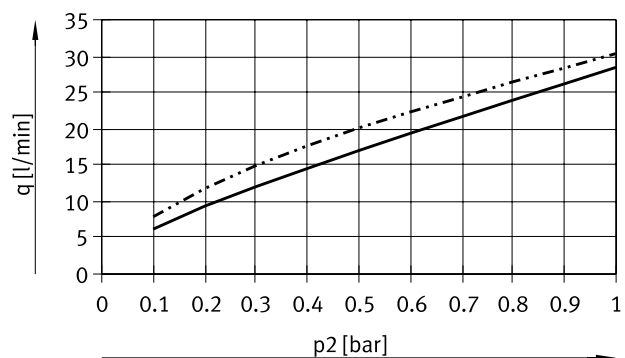

— Flow rate 1 → 2  
 - - - Flow rate 2 → 3

Flow plotted against voltage at room temperature, operating pressure 1 bar

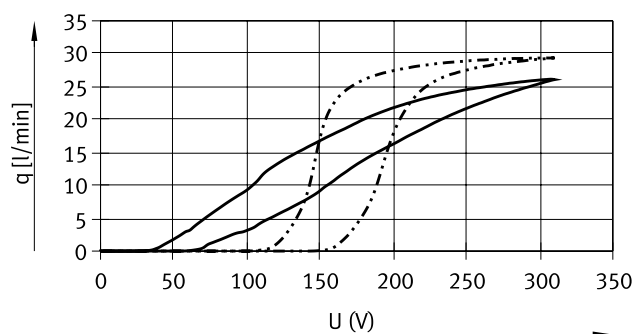

— Flow rate 1 → 2  
 - - - Flow rate 2 → 3

Data sheet

Dimensions

Download CAD data → [www.festo.com](http://www.festo.com)

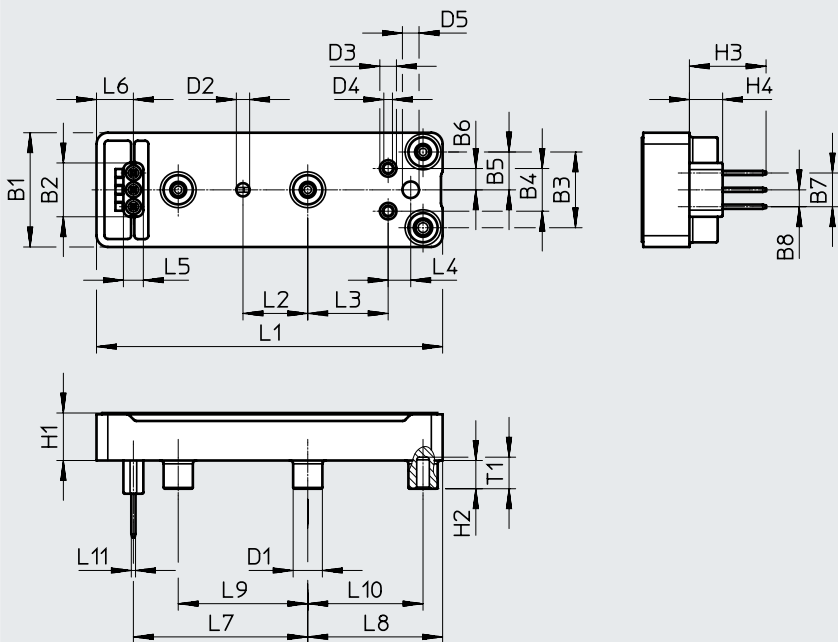

| Type | B1   | B2  | B3   | B4  | B5  | B6  | B7  | B8  | D1<br>∅ | D2<br>∅ | D3<br>∅ | D4<br>∅ | D5<br>∅ |
|------|------|-----|------|-----|-----|-----|-----|-----|---------|---------|---------|---------|---------|
| VEMP | 17.2 | 8.1 | 11.4 | 6.4 | 5.7 | 3.2 | 5.1 | 2.5 | 4.4     | 2       | 2.5     | 1.3/1.6 | 2.5     |

| Type | H1  | H2  | H3   | H4 | L1   | L2  | L3   | L4  | L5 | L6  | L7   | L8   | L9   | L10  | L11 | T1  |
|------|-----|-----|------|----|------|-----|------|-----|----|-----|------|------|------|------|-----|-----|
| VEMP | 7.2 | 4.3 | 11.6 | 5  | 52.1 | 9.8 | 12.1 | 3.4 | 3  | 5.6 | 26.3 | 20.3 | 19.5 | 17.4 | 0.6 | 4.8 |

## Data sheet

## Dimensions

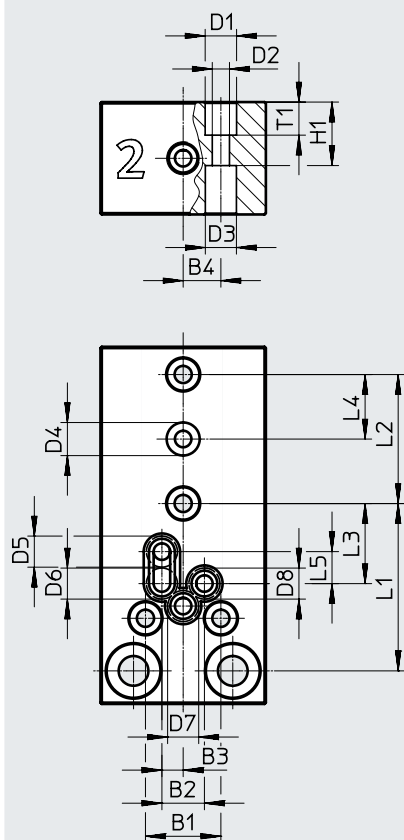

Download CAD data → [www.festo.com](http://www.festo.com)

Example of manifold rail, seal

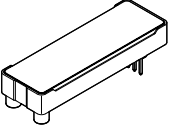
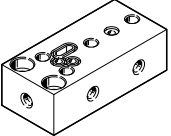

| B1   | B2  | B3  | B4  | D1<br>∅ | D2<br>∅ | D3<br>∅ | D4<br>∅ | D5<br>∅ | D6<br>∅ | D7<br>∅ | D8<br>∅ | H1  | L1   | L2   | L3   | L4  | L5  | T1 |
|------|-----|-----|-----|---------|---------|---------|---------|---------|---------|---------|---------|-----|------|------|------|-----|-----|----|
| 11.4 | 6.4 | 3.2 | 5.7 | 4.8     | 2.6     | 4.7     | 5       | 4.7     | 4.7     | 4.7     | 4.7     | 9.6 | 25.3 | 19.5 | 12.1 | 9.8 | 4.8 | 5  |

## Accessories

| Ordering data  | Description   | Nominal width<br>[mm] | Operating pressure<br>[bar] | Part no. | Type                        |
|--|---|-----------------------|-----------------------------|----------|-----------------------------|
| <b>Sub-base valve</b>  |   |                       |                             |          |                             |
|    | 3/3-way valve (piezo valve), monostable, normally closed  | 1.3                   | 0 ... 1.1                   | 8064292  | VEMP-BS-3-13-D7-F-22T1      |
|  |   |                       |                             | 8064293  | VEMP-BS-3-13-D7-F-22T1-P30  |
|  |   | 1.6                   | 0 ... 1.7                   | 8065734  | VEMP-BS-3-13-D19-F-28T1     |
|  |   |                       |                             | 8065735  | VEMP-BS-3-13-D19-F-28T1-P30 |
|  |   |                       | 0 ... 0.7                   | 8065738  | VEMP-BS-3-16-D5-F-28T1      |
|  |   |                       |                             | 8065739  | VEMP-BS-3-16-D5-F-28T1-P30  |
|  | 0 ... 1.1   | 8064294               | VEMP-BS-3-16-D7-F-28T1      |          |                             |
|  |   | 8064295               | VEMP-BS-3-16-D7-F-28T1-P30  |          |                             |
| <b>Sub-base</b>  |   |                       |                             |          |                             |
|    | For 3/3-way valve, with 4 pneumatic connections M5 (pressure supply port, exhaust, working port, sensor connection).<br>The sensor connection is connected to the working port. |                       |                             | 8068637  | VABS-P12-S-M5-P3            |
| <b>Assortment of seals</b>   |   |                       |                             |          |                             |
|    | For 30 valves, comprising seal (30 units) and O-ring for sensor connection (30 units)   |                       |                             | 8065525  | VABD-P12-S-P30              |
| <b>Screw set</b>   |   |                       |                             |          |                             |
|  | 120 screws for 30 valves (4 screws per valve VEMP)  |                       |                             | 8065526  | VAME-P12-MK                 |