

Bellows cylinders EB

FESTO



Characteristics

Characteristics

- Suitable for use in harsh, dusty ambient conditions
- Can be used under water
- Sturdy design
- Large force range from 1 ... 50 kN
- Low installation height
- No stick-slip effect
- Maintenance-free

Bellows cylinders can be used both as driving and pneumatic spring components. When provided with pressurisation and exhaust functions, the bellows cylinders operate as a driving component. As the stroke increases, the force generated is reduced in relation to the contractional force of the bellows. When bellows cylinders are supplied with permanent pressure, they act as a cushioning component. The simple design consists of two metal connecting plates with an attached rubber bellows. There are no sealing components and no moving mechanical parts. Bellows cylinders are single-acting drives that do not require spring returns, as the reset is achieved by the application of external force.

EB-80

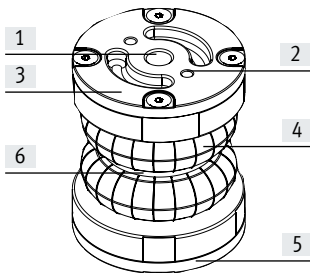

EB-145 ... 385

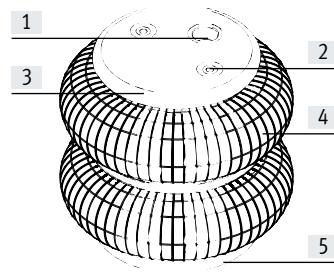

- [1] Pneumatic connection
- [2] Mounting thread
- [3] Top connecting plate
- [4] Bellows
- [5] Bottom connecting plate
- [6] Belt ring

Prerequisites for using a bellows cylinder

Space required

Observe the installation space to ensure that the bellows cylinder does not come into contact with other machine parts as it expands.

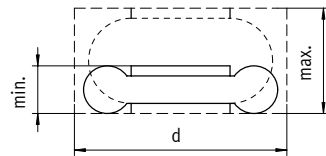

Combined installation

When using two or more bellows cylinders, the necessary mounting plates must be inserted between the cylinders to prevent them from spreading out sideways.

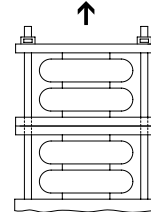

Lateral offset

The maximum lateral offset must not be exceeded.

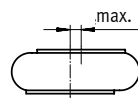

Tilted installation

The maximum tilt angle α must not be exceeded to ensure that the bellows walls cannot touch.

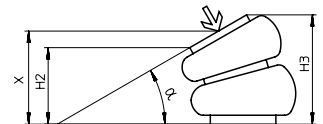

Minimum height

The bellows cylinder must not fall below a minimum height, otherwise it will be damaged.



Maximum height

The bellows cylinder must not exceed a maximum height, otherwise it will be damaged.

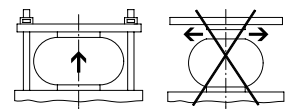

Product range overview

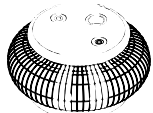
Product range overview						
Function	Version	Type	Size	Stroke [mm]	Thrust ¹⁾ [kN]	Recommended operating height [mm]
Single-acting		Single-bellows cylinder	80	20	1.7	60
			145	60	3.2	90
			165	65	5.7	90
			215	80	8.3	110
			250	85	11.9	110
			325	95	21.8	130
			385	115	31.6	145
		Double-bellows cylinder	80	45	1.4	90
			145	100	2.4	160
			165	125	3.8	175
			215	155	8.0	190
			250	185	10.7	210
			325	215	20.6	240
			385	230	31.5	250

1) At recommended operating height and operating pressure of 6 bar

Type codes

001	Series
EB	Bellows, single-acting

002	Size
80	80
145	145
165	165
215	215
250	250
325	325
385	385

003	Stroke
20	20
45	45
60	60
65	65
80	80
85	85
95	95
100	100
115	115
125	125
155	155
185	185
215	215
230	230

Data sheet

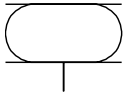

- \varnothing - Diameter
80 ... 385 mm
- | - Stroke length 20 ... 230 mm



General technical data								
Size		80	145	165	215	250	325	385
Pneumatic connection		G1/4	G1/8	G1/4	G3/4	G3/4	G1/4	G1/4
Stroke								
Single-bellows cylinder	[mm]	20	60	65	80	85	95	115
Double-bellows cylinder	[mm]	45	100	125	155	185	215	230
Mode of operation		Single-acting						
Type of mounting		With female thread						
Mounting position		Any						

Operating and environmental conditions								
Size		80	145	165	215	250	325	385
Operating medium		Compressed air to ISO 8573-1:2010 [-:-:4]						
Note on the operating/pilot medium ¹⁾		Operation with lubricated medium not possible						
Operating pressure	[bar]	0 ... 8						
Ambient temperature	[°C]	-40 ... +70						
Corrosion resistance CRC ²⁾		-	2					

1) Additional operating media on request

2) Corrosion resistance class CRC 2 to Festo standard FN 940070

Moderate corrosion stress. Indoor applications in which condensation can occur. External visible parts with primarily decorative surface requirements which are in direct contact with a normal industrial environment.

Weight [g]								
Size		80	145	165	215	250	325	385
Single-bellows cylinder		500	900	1200	2000	2300	4100	5900
Double-bellows cylinder		500	1100	1500	2300	3000	4800	6900

Data sheet

Materials

Sectional view

EB-80

EB-145 ... 385

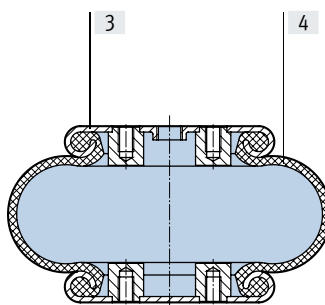
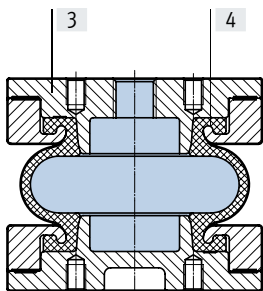

Size	80	145	165	215	250	325	385
[3] Housing	Cast aluminium	Galvanised steel					
[4] Bellows	CR	NR/BR					
- Note on materials	Free of copper and PTFE						
	RoHS-compliant						

Forces [N]							
Size	80	145	165	214	250	325	385
Single-bellows cylinder							
Force/stroke characteristics	→ Page 7						
Resetting force	400	120	200	200	200	300	300
Double-bellows cylinder							
Force/stroke characteristics	→ Page 9						
Resetting force	200	200	200	200	200	300	400

Note

- Bellows cylinders may only be moved against a workpiece, or they must be equipped with limit stops at the end of the stroke, otherwise the bellows walls would be overloaded or it would result in internal damage
- A resetting force is required to press the bellows cylinder to its minimum height. This is generally achieved through the applied weight force
- The entire bearing surfaces of the upper and lower plates must be utilised to absorb forces
- Bellows cylinders must be exhausted before disassembly
- The walls of bellows cylinders must not come into contact with other parts during operation

Data sheet

Thrust F and bellows volume V as a function of the stroke length H

The graph illustrates the change in thrust F with various working pressures and the change in bellows volume V in relation to the stroke length. The minimum installation height H2 must be observed to achieve the indicated forces.

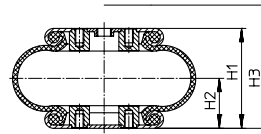

H1 = Recommended operating height
H2 = Min. installation height
H3 = Max. extended height

Single-bellows cylinder

EB-80-20

EB-145-60

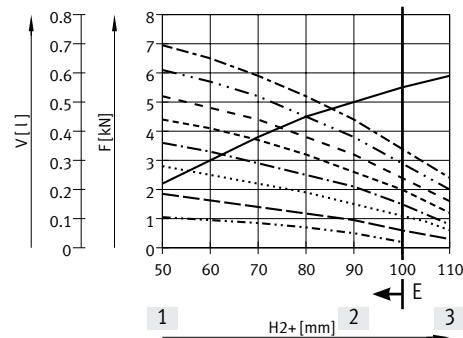
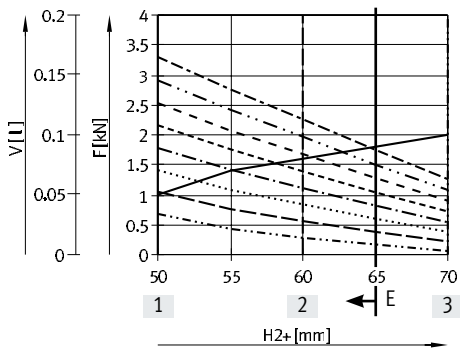

EB-165-65

EB-215-80

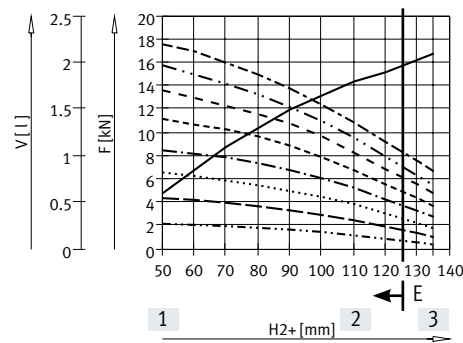
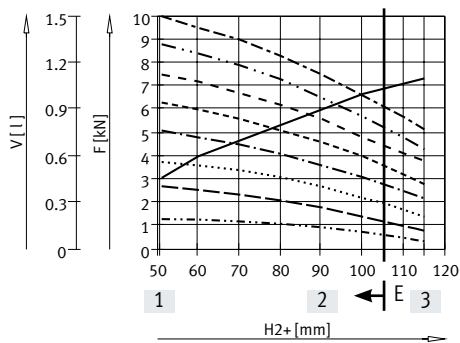

- [1] Min. installation height
 - [2] Recommended operating height for cushioning application at 6 bar
 - [3] Max. extended height
- E Preferred range of application: outside this range, the force reduces to a level so that the use of the next largest size is recommended.

—————	Volume	3 bar	-----	6 bar
- - - - -	1 bar	-----	4 bar	- . - . -	7 bar
-----	2 bar	-----	5 bar	-----	8 bar

Data sheet

Thrust F and bellows volume V as a function of the stroke length H

The graph illustrates the change in thrust F with various working pressures and the change in bellows volume V in relation to the stroke length. The minimum installation height H2 must be observed to achieve the indicated forces.

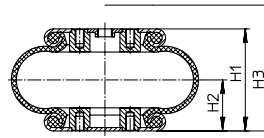

H1 = Recommended operating height
 H2 = Min. installation height
 H3 = Max. extended height

Single-bellows cylinder

EB-250-85

EB-325-95

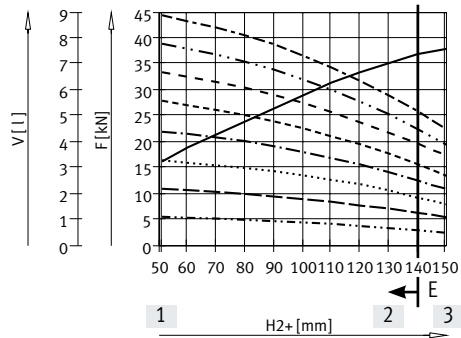
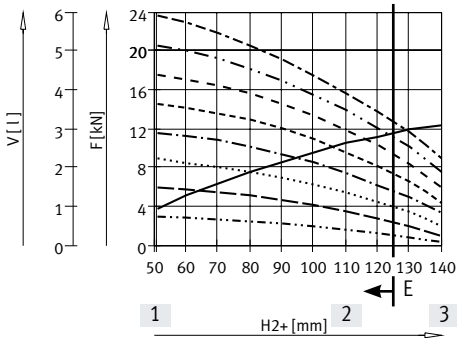

EB-385-115

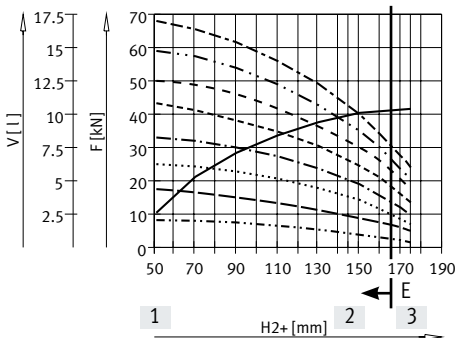

- [1] Min. installation height
- [2] Recommended operating height for cushioning application at 6 bar
- [3] Max. extended height
- E Preferred range of application: outside this range, the force reduces to a level so that the use of the next largest size is recommended.

————— Volume 3 bar	----- 6 bar
..... 1 bar	----- 4 bar	- . - . - 7 bar
----- 2 bar	----- 5 bar 8 bar

Data sheet

Thrust F and bellows volume V as a function of the stroke length H

The graph illustrates the change in thrust F with various working pressures and the change in bellows volume V in relation to the stroke length. The minimum installation height H2 must be observed to achieve the indicated forces.

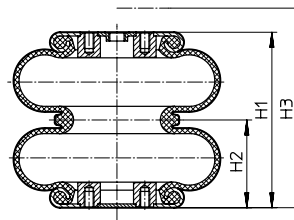

H1 = Recommended operating height
H2 = Min. installation height
H3 = Max. extended height

Double-bellows cylinder

EB-80-45

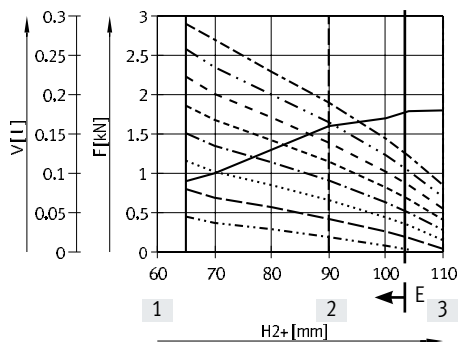

EB-145-100

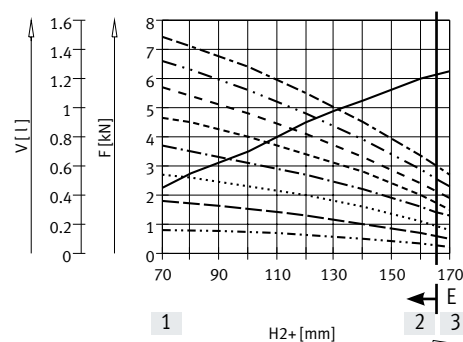

EB-165-125

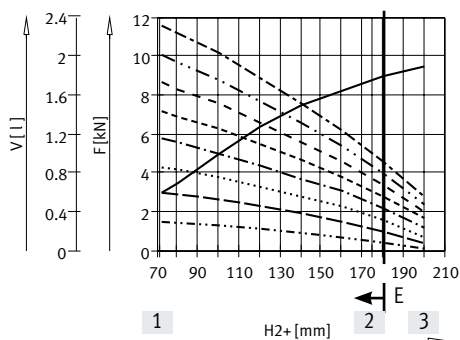

EB-215-155

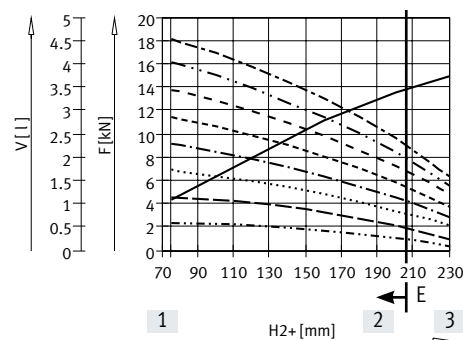

- [1] Min. installation height
- [2] Recommended operating height for cushioning application at 6 bar
- [3] Max. extended height
- E Preferred range of application: outside this range, the force reduces to a level so that the use of the next largest size is recommended.

— Volume 3 bar	--- 6 bar
..... 1 bar	-.-.-.- 4 bar	-.-.-.- 7 bar
--- 2 bar	----- 5 bar 8 bar

Data sheet

Thrust F and bellows volume V as a function of the stroke length H

The graph illustrates the change in thrust F with various working pressures and the change in bellows volume V in relation to the stroke length. The minimum installation height H2 must be observed to achieve the indicated forces.

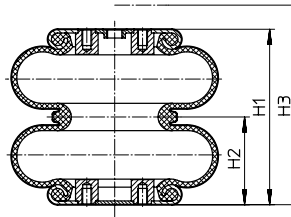

H1 = Recommended operating height
 H2 = Min. installation height
 H3 = Max. extended height

Double-bellows cylinder

EB-250-185

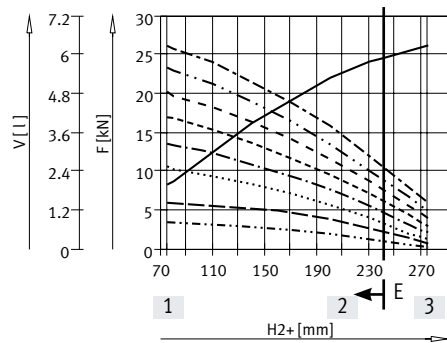

EB-325-215

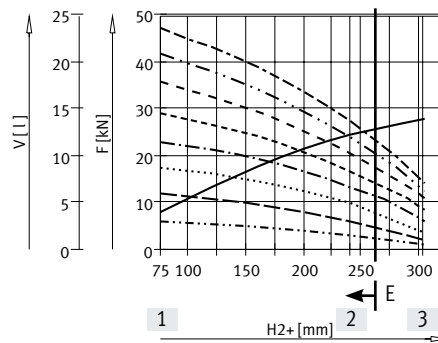

EB-385-230

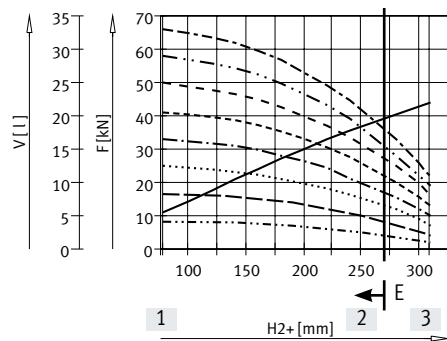

- [1] Min. installation height
- [2] Recommended operating height for cushioning application at 6 bar
- [3] Max. extended height
- E Preferred range of application: outside this range, the force reduces to a level so that the use of the next largest size is recommended.

————— Volume 3 bar	----- 6 bar
..... 1 bar	----- 4 bar	----- 7 bar
----- 2 bar	----- 5 bar	----- 8 bar

Data sheet

Dimensions

Download CAD data → www.festo.com

Single-bellows cylinder – EB-80

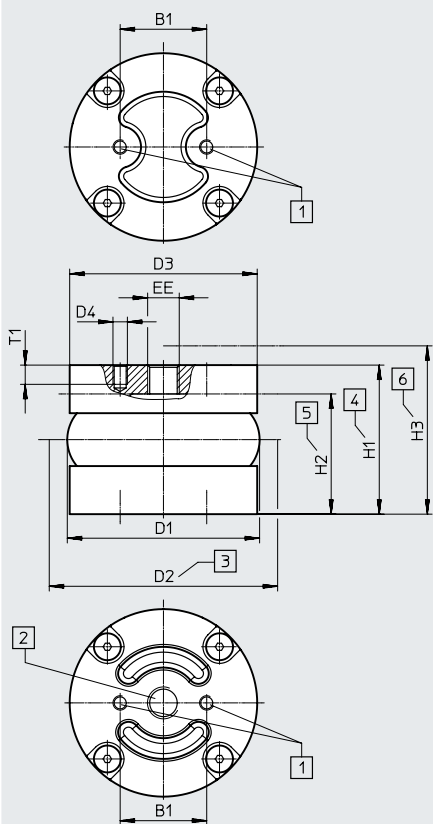

Max. offset between mounting surfaces:

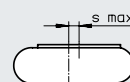

The stroke of the bellows cylinder can be made to carry out a circular path, in which case the indicated tilt angle α must not be exceeded. During setup the minimum height must be observed, and that the maximum height must not be exceeded at any given point.

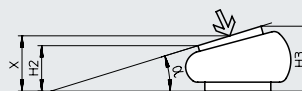

- [1] Mounting thread
- [2] Compressed air supply port
- [3] Required installation space
- [4] Recommended operating height
- [5] Min. installation height
- [6] Max. extended height

Type	B1	D1 ∅ max.	D2 ∅	D3 ∅	D4	EE
EB-80-20	36	80	95	78	M6	G1/4

Type	H1	H2 min.	H3 max.	T1 min.	s_{max}	Tilt angle α max.
EB-80-20	60	50	70	8	5	10°

Data sheet

Dimensions

Download CAD data → www.festo.com

Single-bellows cylinder – EB-145 ... 385

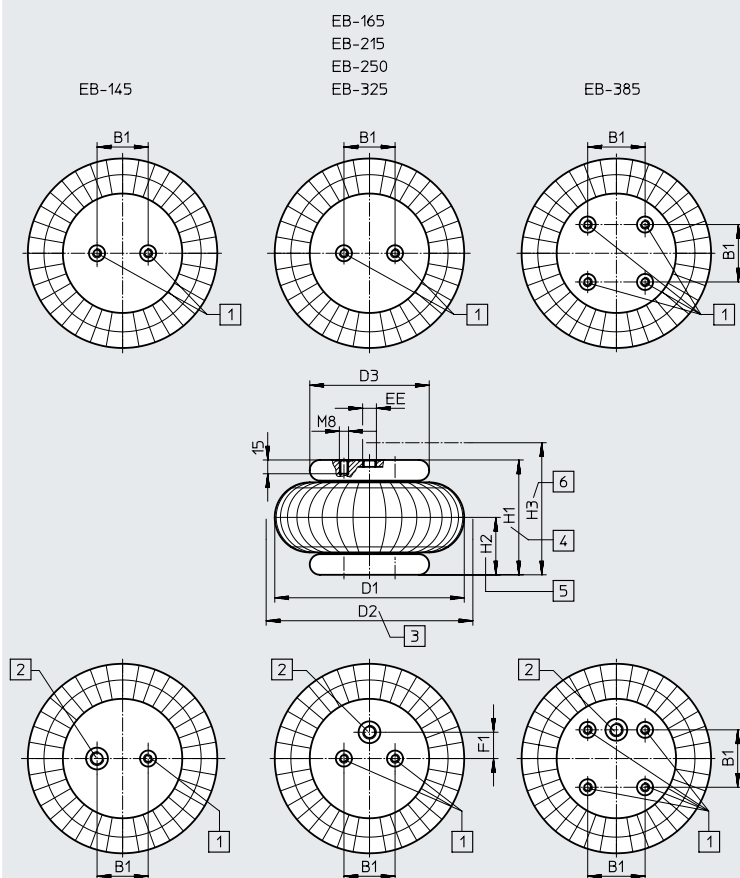

Max. offset between mounting surfaces:

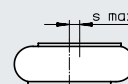

The stroke of the bellows cylinder can be made to carry out a circular path, in which case the indicated tilt angle α must not be exceeded. During setup the minimum height must be observed, and that the maximum height must not be exceeded at any given point.

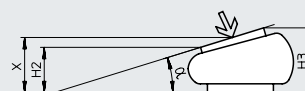

- [1] Mounting thread
- [2] Compressed air supply port
- [3] Required installation space
- [4] Recommended operating height
- [5] Min. installation height
- [6] Max. extended height

Type	B1 ±0.2	D1 ∅ max.	D2 ∅	D3 ∅	D4	EE	F1 ±0.2
EB-145-60	20	145	160	90	M8	G1/8	–
EB-165-65	44.5	165	180	108	M8	G1/4	0
EB-215-80	70	215	230	141	M8	G3/4	0
EB-250-85	89	250	265	161	M8	G3/4	38.1
EB-325-95	157.5	325	340	228	M8	G1/4	73
EB-385-115	158.8	385	400	287	M8	G1/4	79.4

Type	H1	H2 min.	H3 max.	T1 min.	s _{max}	Tilt angle α max.
EB-145-60	90	50	110	15	10	20°
EB-165-65	90	51	115	15	10	20°
EB-215-80	110	50	135	15	10	20°
EB-250-85	110	51	140	15	10	20°
EB-325-95	130	51	150	15	10	15°
EB-385-115	145	51	175	15	10	15°

Data sheet

Dimensions

Download CAD data → www.festo.com

Double-bellows cylinder – EB-80

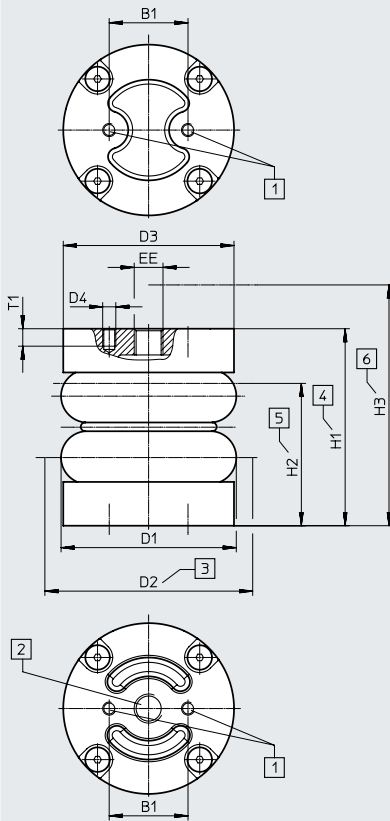

- [1] Mounting thread
- [2] Compressed air supply port
- [3] Required installation space
- [4] Recommended operating height
- [5] Min. installation height
- [6] Max. extended height

Max. offset between mounting surfaces:

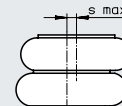

The stroke of the bellows cylinder can be made to carry out a circular path, in which case the indicated tilt angle α must not be exceeded. During setup the minimum height must be observed, and that the maximum height must not be exceeded at any given point.

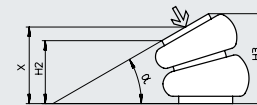

Type	B1	D1 ∅ max.	D2 ∅	D3 ∅	D4	EE
EB-80-45	36	80	95	78	M6	G1/4

Type	H1	H2 min.	H3 max.	T1 min.	S _{max}	Tilt angle α max.
EB-80-45	90	65	110	8	10	15°

Data sheet

Dimensions

Download CAD data → www.festo.com

Double-bellows cylinder – EB-145 ... 385

EB-165
EB-215
EB-250
EB-325

EB-145

EB-385

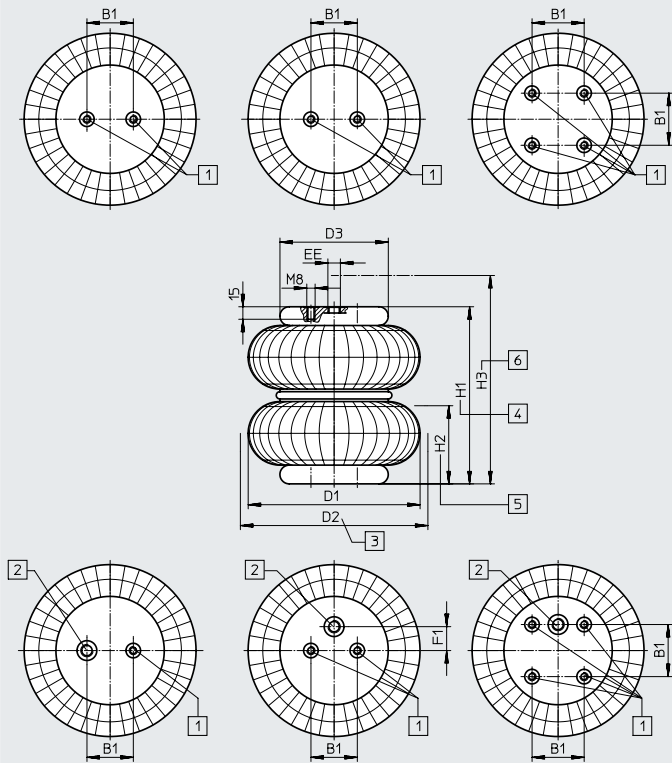

- [1] Mounting thread
- [2] Compressed air supply port
- [3] Required installation space
- [4] Recommended operating height
- [5] Min. installation height
- [6] Max. extended height

Max. offset between mounting surfaces:

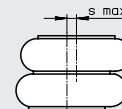

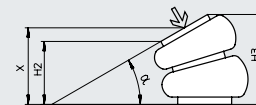

The stroke of the bellows cylinder can be made to carry out a circular path, in which case the indicated tilt angle α must not be exceeded. During setup the minimum height must be observed, and that the maximum height must not be exceeded at any given point.



Type	B1 ±0.2	D1 ∅ max.	D2 ∅	D3 ∅	D4	EE	F1 ±0.2
EB-145-100	20	145	160	90	M8	G1/8	–
EB-165-125	44.5	165	180	108	M8	G1/4	0
EB-215-155	70	215	230	141	M8	G3/4	0
EB-250-185	89	250	265	161	M8	G3/4	38.1
EB-325-215	157.5	325	340	228	M8	G1/4	73
EB-385-230	158.8	385	400	287	M8	G1/4	79.4

Type	H1	H2 min.	H3 max.	T1 min.	s _{max}	Tilt angle α max.
EB-145-100	160	70	170	15	20	30°
EB-165-125	175	72	200	15	20	30°
EB-215-155	190	75	230	15	20	30°
EB-250-185	210	75	275	15	20	25°
EB-325-215	240	75	305	15	20	20°
EB-385-230	250	77	310	15	20	20°

Data sheet

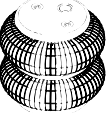
Ordering data				
Type	Size	Stroke [mm]	Part no.	Type
Single-bellows cylinder				
	80	20	2748903	EB-80-20
	145	60	36486	EB-145-60
	165	65	36487	EB-165-65
	215	80	36488	EB-215-80
	250	85	36489	EB-250-85
	325	95	193788	EB-325-95
	385	115	193789	EB-385-115
Double-bellows cylinder				
	80	45	2748904	EB-80-45
	145	100	36490	EB-145-100
	165	125	36491	EB-165-125
	215	155	36492	EB-215-155
	250	185	36493	EB-250-185
	325	215	193790	EB-325-215
	385	230	193791	EB-385-230