

Angle grippers HGWM, micro



Key features

At a glance

- Compact, handy designs
- With open or closed gripper jaws
- Versatile thanks to externally adaptable gripper fingers
- Wide range of options for mounting on drives
- With stroke compensation after installation
- Mounting options:
 - Clamping spigot
 - Male thread

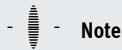

Note

Engineering software
for gripper selection
→ www.festo.com

Variants

With stroke compensation

With male thread

With clamping spigot



Mounting options for external gripper fingers (customer-specific)

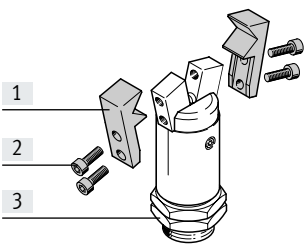

- [1] External gripper fingers
- [2] Retaining screws
- [3] Angle gripper

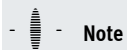

Note

These grippers are not suitable for the following or similar applications:

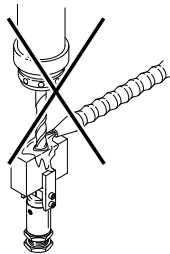

- Machining
- Aggressive media



- Grinding dust

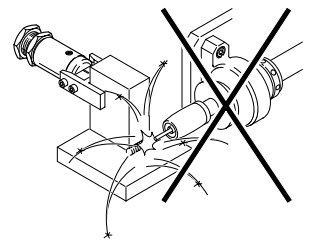

- Welding spatter

Key features

Mounting options

With through-holes

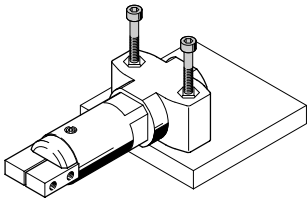

With through-holes, screws and retaining nuts

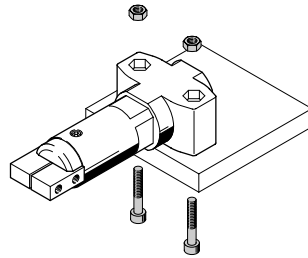

With threaded pin
Direct air supply

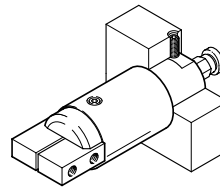

Integrated air supply

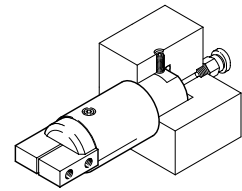

With male thread and lock nut

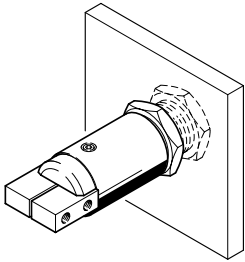

Type codes

Data sheet

Single-acting
with open gripper jaws
HGWM-...-EO-G...



with closed gripper jaws
HGWM-...-EZ-G...

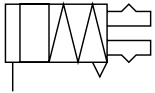

⌀ Size
8 ... 12 mm



General technical data				
Size	8		12	
Design	Wedge-shaped actuator			
Mode of operation	Single-acting			
Gripper function	Angular			
Number of gripper jaws	2			
Opening angle (±2°)				
Gripper jaws open	Open	[°]	20	18.5
	Closed	[°]	4	3.5
Gripper jaws closed	Open	[°]	14	14
	Closed	[°]	4	4
Spring resetting torque ¹⁾				
Gripper jaws open	[Ncm]	0.5	1.3	
Gripper jaws closed	[Ncm]	0.55	1.5	
Pneumatic connection	M3			
Repetition accuracy ^{2) 3)}	[mm]	< 0.02		
Max. operating frequency	[Hz]	4		
Position sensing	None			
Type of mounting				
HGWM-...-E...-G6	With female thread			
HGWM-...-E...-G7	With lock nut			
HGWM-...-E...-G8	Clamped			

- 1) Spring resetting force between the gripper jaws
- 2) End-position drift under constant operating conditions with 100 consecutive strokes in the direction of movement of the gripper jaws
- 3) The indicated values are only valid when gripping with compressed air, not with spring force

Operating and environmental conditions		
Min. operating pressure	[bar]	2
Max. operating pressure	[bar]	8
Operating medium	Compressed air to ISO 8573-1:2010 [7:-:-]	
Ambient temperature	[°C]	+5 ... +60
Corrosion resistance class CRC ¹⁾	2	

- 1) Corrosion resistance class CRC 2 to Festo standard FN 940070
Moderate corrosion stress. Indoor applications in which condensation can occur. External visible parts with primarily decorative surface requirements which are in direct contact with a normal industrial environment.

Weight [g]		
Size	8	12
With stroke compensation	23	75
With male thread	14	52
With clamping spigot	13	45

Data sheet

Materials

Sectional view

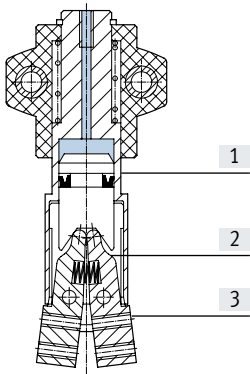

Angle gripper		
[1]	Housing	Stainless steel
[2]	Gripper jaws	Stainless steel
[3]	Cover cap	Polyacetal
-	Note on materials	Free of copper and PTFE RoHS-compliant

Total gripping torque [Ncm] at 6 bar

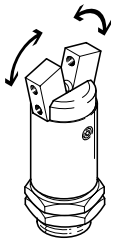

Size	8		12	
	HGWM-...EO-...	HGWM-...EZ-...	HGWM-...EO-...	HGWM-...EZ-...
Total gripping torque				
Opening	-	24	-	76
Closing	22	-	64	-

Characteristic load values at the gripper jaws

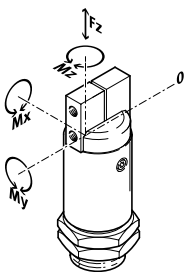

The indicated permissible forces and torques apply to a single gripper jaw. Static forces and torques relate to additional weight forces caused by the workpiece or external gripper fingers, as well as acceleration forces which occur during operation. The zero coordinate line (gripper jaws point of rotation) must be taken into consideration for the calculation of torques.

Size	8		12	
	Max. permissible force F_z	[N]	7	
Max. permissible torque M_x	[Ncm]	20		40
Max. permissible torque M_y	[Ncm]	20		40
Max. permissible torque M_z	[Ncm]	20		40

Data sheet

Weight force [N] and mass moments of inertia [$\text{kgm}^2 \times 10^{-4}$] per external gripper finger

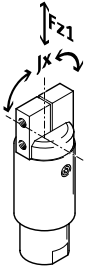

Size	8	12
Weight force $F_{z1}^{1)}$	< 0.04	< 0.1
Mass moments of inertia $J_{x1}^{1)}$	< 0.025	< 0.056

1) Applies to unthrottled operation

Mass moments of inertia [$\text{kgm}^2 \times 10^{-4}$]

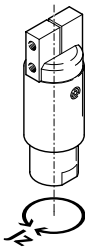

Mass moment of inertia [$\text{kgm}^2 \times 10^{-4}$] for the angle grippers in relation to the central axis without external gripper fingers.

Size	8	12
With stroke compensation	0.00705	0.0421
With male thread	0.00315	0.0267
With clamping spigot	0.00252	0.02154

Opening and closing times [ms] at 6 bar

Without external gripper fingers

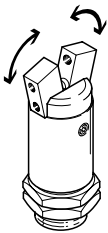

The indicated opening and closing times [ms] have been measured at room temperature and 6 bar operating pressure with a vertically mounted gripper and without additional gripper fingers. The load is increased if external gripper fingers are attached. This means that kinetic energy is also increased, as this is determined by the gripper finger's mass moment of inertia and angular velocity.

Size		8	12
HGWM-...EO-...	Opening	2.7	3.7
	Closing	1.2	1.8
HGWM-...EZ-...	Opening	1	1.7
	Closing	2.5	2.8

Data sheet

Gripper jaw backlash

Without external gripper fingers

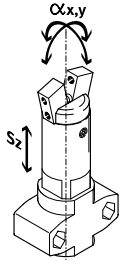

With the angle grippers, there is backlash between the gripper jaws and the guide element due to the plain-bearing guide. The backlash values listed in the table have been calculated based on the traditional accumulative tolerance method and usually do not occur with mounted grippers.

Size	8	12
Gripper jaw backlash s_z [mm]	< 0.03	
Gripper jaw angular backlash α_x, α_y [°]	< 0.5	

Spring displacement forces [N]

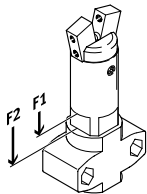

Theoretical actuating force due to stroke compensation for the design variant with stroke compensation.

Size	8	12
Spring displacement forces F_1	4	10
Spring displacement forces F_2	6	23

Data sheet

Dimensions

Download CAD data → www.festo.com

With stroke compensation – HGWM-...-E...-G6

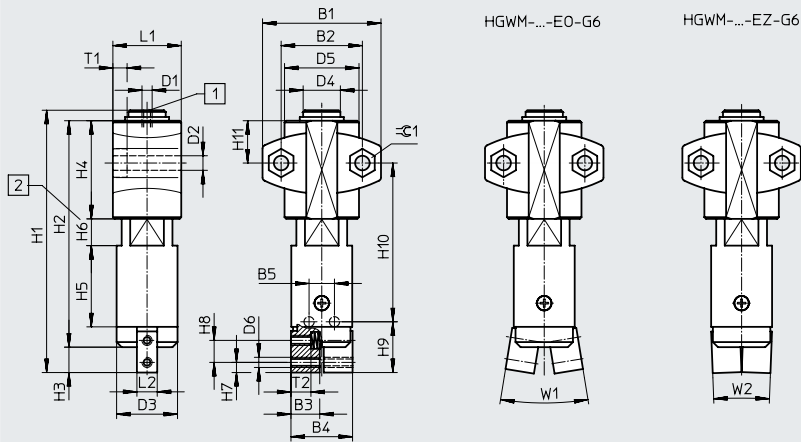

- [1] Compressed air supply port
- [2] Stroke compensation

With male thread – HGWM-...-E...-G7

HGWM-...-E0-G7 HGWM-...-EZ-G7

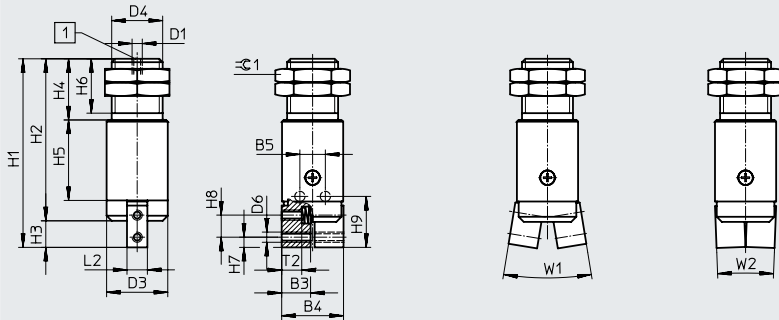

- [1] Compressed air supply port

With clamping spigot – HGWM-...-E...-G8

HGWM-...-E0-G8 HGWM-...-EZ-G8

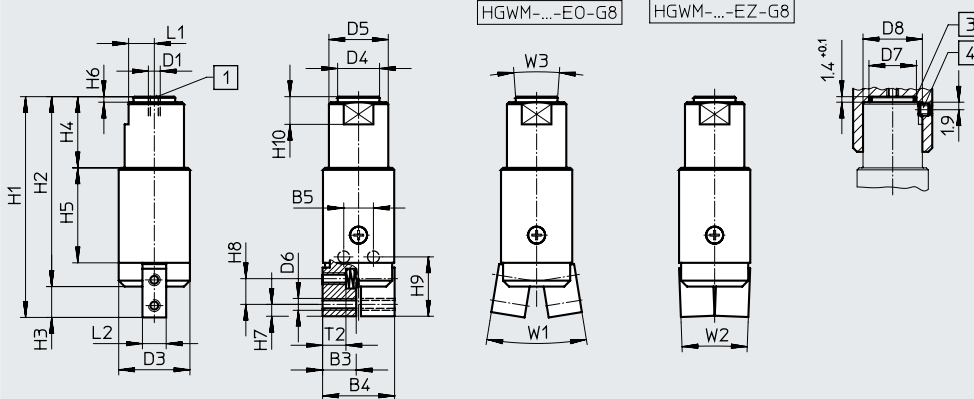

- [1] Compressed air supply port
- [3] O-ring:
HGWM-08: 6x1
HGWM-12: 10x1
(not included in the scope of delivery)
- [4] Threaded pin M3x3 DIN 913
(not included in the scope of delivery)

Data sheet

Type	B1 ±0.1	B2 ±0.25	B3	B4 ±0.3	B5	D1	D2 ∅ +0.1	D3 ∅ +0.1	D4 ∅	D5 ∅	D6
HGWM-08-EO-G6	24	15	5.5	11.8	5 ±0.02	M3	3.4	12	8 -0.02/-0.05	15 ±0.5	M2
HGWM-08-EZ-G6											
HGWM-12-EO-G6	35	24	8.5	18.2	7.5 -0.05	M3	4.5	18	11 -0.02/-0.05	22 ±0.5	M3
HGWM-12-EZ-G6											
HGWM-08-EO-G7	-	-	5.5	11.8	5 ±0.02	M3	-	12	M10x1	-	M2
HGWM-08-EZ-G7											
HGWM-12-EO-G7	-	-	8.5	18.2	7.5 -0.05	M3	-	18	M15x1.5	-	M3
HGWM-12-EZ-G7											
HGWM-08-EO-G8	-	-	5.5	11.8	5 ±0.02	M3	-	12	6.6 -0.03	10 h8	M2
HGWM-08-EZ-G8											
HGWM-12-EO-G8	-	-	8.5	18.2	7.5 -0.05	M3	-	18	10.6 -0.03	15 h8	M3
HGWM-12-EZ-G8											

Type	D7 ∅ +0.1	D8 +0.1	H1 +0.25	H2	H3	H4	H5 +0.1	H6	H7	H8	H9 +0.1
HGWM-08-EO-G6	-	-	54	47 ±0.3	5 ±0.2	22-0.3	16	0 ... 5 +0.6/-0.3	2	4.3	10
HGWM-08-EZ-G6											
HGWM-12-EO-G6	-	-	77.5	67 ±0.3	7.5	29-0.3	24	0 ... 8 +0.6/-0.3	3	6.5	15
HGWM-12-EZ-G6											
HGWM-08-EO-G7	-	-	37	32 +0.3/-0.2	5 ±0.2	12	16	11	2	4.3	10
HGWM-08-EZ-G7											
HGWM-12-EO-G7	-	-	55.5	48 +0.3/-0.2	7.5	18	24	16	3	6.5	15
HGWM-12-EZ-G7											
HGWM-08-EO-G8	8	10	37	32 +0.3/-0.2	5 ±0.2	12	16	1.4 -0.1	2	4.3	10
HGWM-08-EZ-G8											
HGWM-12-EO-G8	12	15	55.5	48 +0.3/-0.2	7.5	18	24	1.4 -0.1	3	6.5	15
HGWM-12-EZ-G8											

Type	H10	H11 ±0.3	L1	L2 -0.02	T1 -0.2	T2 ¹⁾	W1 ±2°	W2 ±2°	W3 ±2°	⊕C1
HGWM-08-EO-G6	32.4 ±0.6	9.5	14.2 -0.2	4	3	3.4 ±0.2	20°	4°	-	5.7
HGWM-08-EZ-G6						-	14°			
HGWM-12-EO-G6	47 ±0.6	12.5	20.2 -0.2	6	4	5.9	18.5°	3.5°	-	7.5
HGWM-12-EZ-G6						-	14°	4°		
HGWM-08-EO-G7	-	-	-	4	-	3.4 ±0.2	20°	4°	-	12
HGWM-08-EZ-G7						-	14°			
HGWM-12-EO-G7	-	-	-	6	-	5.9	18.5°	3.5°	-	19
HGWM-12-EZ-G7						-	14°	4°		
HGWM-08-EO-G8	5	-	4.5 -0.05	4	-	3.4 ±0.2	20°	4°	8°	-
HGWM-08-EZ-G8						-	14°			
HGWM-12-EO-G8	7	-	6.5 -0.05	6	-	5.9	18.5°	3.5°	8°	-
HGWM-12-EZ-G8						-	14°	4°		

1) Do not exceed max. thread screw-in depth

Ordering data		Mounting variants					
Single-acting	Size [mm]	With stroke compensation		With male thread		With clamping spigot	
		Part no.	Type	Part no.	Type	Part no.	Type
Gripper jaws open	8	185693	HGWM-08-EO-G6	185694	HGWM-08-EO-G7	185695	HGWM-08-EO-G8
	12	185699	HGWM-12-EO-G6	185700	HGWM-12-EO-G7	185701	HGWM-12-EO-G8
Gripper jaws closed	8	185696	HGWM-08-EZ-G6	185697	HGWM-08-EZ-G7	185698	HGWM-08-EZ-G8
	12	185702	HGWM-12-EZ-G6	185703	HGWM-12-EZ-G7	185704	HGWM-12-EZ-G8