

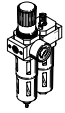

Lubricators LOE, D series

FESTO

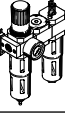

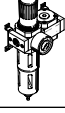
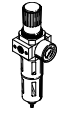
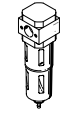
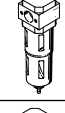
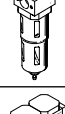



Product range overview – Service unit components, D series, metal

Type	Size	Pneumatic connection										Pressure regulation range [bar]			Grade of filtration [µm]			
		M5	M7	G1/8	G1/4	G3/8	G1/2	G3/4	G1	QS4	QS6	0.5 ... 7	0.5 ... 12	2.5 ... 12	0.01	1	5	40
Service units																		
FRC/FRCS 	Mini	-	-	■	■	■	-	-	-	-	-	■	■	-	-	-	■	■
	Midi	-	-	-	■	■	■	■	-	-	-	■	■	-	-	-	■	■
	Maxi	-	-	-	-	-	■	■	■	-	-	■	■	-	-	-	■	■
Service unit combinations																		
FRC-K 	Micro	-																
	Mini	-	-	■	■	-	-	-	-	-	-	■	■	-	-	-	-	■
	Midi	-	-	-	■	■	■	-	-	-	-	■	■	-	-	-	-	■
	Maxi	-	-	-	-	-	■	■	-	-	-	-	■	■	-	-	-	■
LFR-K LFRS-K 	Micro	-																
	Mini	-	-	■	■	-	-	-	-	-	-	■	■	-	-	-	-	■
	Midi	-	-	-	■	■	■	-	-	-	-	■	■	-	-	-	-	■
	Maxi	-	-	-	-	-	■	■	-	-	-	-	■	■	-	-	-	■
Individual devices																		
Filter regulators LFR/LFRS 	Micro	■	■	■	-	-	-	-	-	■	■	■	-	-	-	-	■	-
	Mini	-	-	■	■	■	-	-	-	-	-	■	■	-	-	-	■	■
	Midi	-	-	-	■	■	■	-	-	-	-	■	■	-	-	-	■	■
	Maxi	-	-	-	-	-	■	■	■	-	-	-	■	■	-	-	-	■
Filter LF 	Mini	-	-	■	■	■	-	-	-	-	-	-	-	-	-	-	■	■
	Midi	-	-	-	■	■	■	■	-	-	-	-	-	-	-	-	■	■
	Maxi	-	-	-	-	-	■	■	■	-	-	-	-	-	-	-	■	■
Fine and micro filters LFMA/LFMB 	Micro	-																
	Mini	-	-	■	■	■	-	-	-	-	-	-	-	-	■	■	-	-
	Midi	-	-	-	■	■	■	■	-	-	-	-	-	-	■	■	-	-
	Maxi	-	-	-	-	-	■	■	■	-	-	-	-	-	■	■	-	-
Activated carbon filter LFX 	Micro	-																
	Mini	-	-	■	■	■	-	-	-	-	-	-	-	-	-	-	-	-
	Midi	-	-	-	■	■	■	■	-	-	-	-	-	-	-	-	-	-
	Maxi	-	-	-	-	-	■	■	■	-	-	-	-	-	-	-	-	-
Filter combinations LFMBA 	Micro	-																
	Mini	-	-	■	■	■	-	-	-	-	-	-	-	-	■	■	-	-
	Midi	-	-	-	■	■	■	■	-	-	-	-	-	-	■	■	-	-
	Maxi	-	-	-	-	-	■	■	■	-	-	-	-	-	■	■	-	-
Pressure regulators LR/LRS 	Mini	-	-	■	■	■	-	-	-	-	-	■	■	-	-	-	-	-
	Midi	-	-	-	■	■	■	■	-	-	-	■	■	-	-	-	-	-
	Maxi	-	-	-	-	-	■	■	■	-	-	■	■	-	-	-	-	-

Product range overview – Service unit components, D series, metal

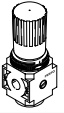
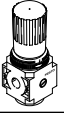
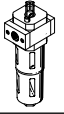
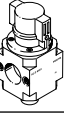
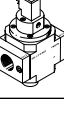
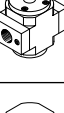
Type	Size	Bowl guard		Condensate drain			Pressure display		Actuator lock		Supply voltage			Options			→ Page/ Internet
		Metal bowl guard	Plastic bowl	Manual rotary	Semi-automatic	Fully automatic	With pressure gauge	Without pressure gauge	Rotary knob with latch	Rotary knob with integrated lock	24 V DC	110 V AC	230 V AC	Directly actuated pressure regulator with integrated return flow function	Pilot actuated pressure regulator with integrated return flow function	Differential pressure display	
Service units																	
FRC/FRCS	Mini	■	-	■	-	■	■	■	■	■	-	-	-	-	-	-	frc
	Midi	■	-	■	-	■	■	■	■	■	-	-	-	-	-	-	
	Maxi	■	-	■	-	■	■	■	■	■	-	-	-	■	■	-	
Service unit combinations																	
FRC-K	Micro	-	-	-	-	-	-	-	-	-	-	-	-	-	-	-	frc
	Mini	■	-	■	-	■	■	-	■	-	■	-	-	-	-	-	
	Midi	■	-	■	-	■	■	-	■	-	■	-	-	-	-	-	
	Maxi	■	-	■	-	■	■	-	■	-	■	-	-	■	■	-	
LFR-K LFRS-K	Micro	-	-	-	-	-	-	-	-	-	-	-	-	-	-	-	frc
	Mini	■	-	■	-	■	■	-	■	■	■	-	-	-	-	-	
	Midi	■	-	■	-	■	■	-	■	■	■	-	-	-	-	-	
	Maxi	■	-	■	-	■	■	-	■	■	■	-	-	■	■	-	
Individual devices																	
Filter regulators LFR/LFRS	Micro	-	■	■	■	-	■	■	■	-	-	-	-	-	-	-	lfr
	Mini	■	-	■	-	■	■	■	■	■	-	-	-	-	-	-	
	Midi	■	-	■	-	■	■	■	■	■	-	-	-	-	-	-	
	Maxi	■	-	■	-	■	■	■	■	■	-	-	-	■	■	-	
Filter LF	Mini	■	-	■	-	■	-	-	-	-	-	-	-	-	-	-	lf
	Midi	■	-	■	-	■	-	-	-	-	-	-	-	-	-	-	
	Maxi	■	-	■	-	■	-	-	-	-	-	-	-	-	-	-	
Fine and micro filters LFMA/LFMB	Micro	-	-	-	-	-	-	-	-	-	-	-	-	-	-	-	lfma, lfmb
	Mini	■	-	■	-	■	-	-	-	-	-	-	-	-	-	■	
	Midi	■	-	■	-	■	-	-	-	-	-	-	-	-	-	■	
	Maxi	■	-	■	-	■	-	-	-	-	-	-	-	-	-	■	
Activated carbon filter LFX	Micro	-	-	-	-	-	-	-	-	-	-	-	-	-	-	-	lfx
	Mini	■	-	-	-	-	-	-	-	-	-	-	-	-	-	-	
	Midi	■	-	-	-	-	-	-	-	-	-	-	-	-	-	-	
	Maxi	■	-	-	-	-	-	-	-	-	-	-	-	-	-	-	
Filter combinations LFMBA	Micro	-	-	-	-	-	-	-	-	-	-	-	-	-	-	-	lfmba
	Mini	■	-	■	-	■	-	-	-	-	-	-	-	-	-	■	
	Midi	■	-	■	-	■	-	-	-	-	-	-	-	-	-	■	
	Maxi	■	-	■	-	■	-	-	-	-	-	-	-	-	-	■	
Pressure regulators LR/LRS	Mini	-	-	-	-	-	■	■	■	■	-	-	-	■	-	-	lr
	Midi	-	-	-	-	-	■	■	■	■	-	-	-	■	-	-	
	Maxi	-	-	-	-	-	■	■	■	■	-	-	-	■	■	-	
	Maxi	-	-	-	-	-	-	-	-	-	-	-	-	-	-	-	

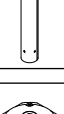
Product range overview – Service unit components, D series, metal

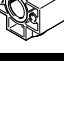
Type	Size	Pneumatic connection										Pressure regulation range [bar]		
		M5	M7	G1/8	G1/4	G3/8	G1/2	G3/4	G1	QS4	QS6	0.5 ... 7	0.5 ... 12	
Individual devices														
Pressure regulators LRB/LRBS		Micro	–											
		Mini	–	–	–	■	–	–	–	–	–	–	■	■
		Midi	–	–	–	–	■	–	–	–	–	–	■	■
		Maxi	–											
Pressure regulator manifolds LRB-K		Micro	–											
		Mini	–	–	–	■	■	–	–	–	–	–	■	■
		Midi	–	–	–	–	■	■	–	–	–	–	■	■
		Maxi	–											
Lubricators LOE		Mini	–	–	■	■	■	–	–	–	–	–	–	
		Midi	–	–	–	■	■	■	■	–	–	–	–	
		Maxi	–	–	–	–	–	■	■	■	–	–	–	
On/off valves HE		Micro	–											
		Mini	–	–	■	■	■	–	–	–	–	–	–	
		Midi	–	–	–	■	■	■	■	–	–	–	–	
		Maxi	–	–	–	–	–	■	■	■	–	–	–	
On/off valves HEE		Micro	–											
		Mini	–	–	■	■	■	–	–	–	–	–	–	
		Midi	–	–	–	■	■	■	■	–	–	–	–	
		Maxi	–	–	–	–	–	■	■	■	–	–	–	
On/off valves HEP		Micro	–											
		Mini	–	–	■	■	■	–	–	–	–	–	–	
		Midi	–	–	–	■	■	■	■	–	–	–	–	
		Maxi	–	–	–	–	–	■	■	■	–	–	–	
Soft-start valves HEL		Micro	–											
		Mini	–	–	■	■	■	–	–	–	–	–	–	
		Midi	–	–	–	■	■	■	■	–	–	–	–	
		Maxi	–	–	–	–	–	■	■	■	–	–	–	
Membrane air dryers LDM1		Micro	–											
		Mini	–											
		Midi	–											
		Maxi	–	–	–	–	–	■	■	■	–	–	–	
Branching modules FRM		Micro	–											
		Mini	–	–	■	■	■	–	–	–	–	–	–	
		Midi	–	–	–	■	■	■	■	–	–	–	–	
		Maxi	–	–	–	–	–	■	■	■	–	–	–	
Distributor block FRZ		Mini	–	–	–	–	–	–	–	–	–	–	–	
		Midi	–	–	–	–	–	–	–	–	–	–	–	
		Maxi	–	–	–	–	–	–	–	–	–	–	–	

Product range overview – Service unit components, D series, metal

Type	Size	Bowl guard		Pressure display		Actuator lock		Supply voltage			Options		→ Page/ Internet	
		Metal bowl guard	Plastic bowl	With pressure gauge	Without pressure gauge	Rotary knob with latch	Rotary knob with integrated lock	24 V DC	110 V AC	230 V AC	With non-return function	Pressure switch		
Individual devices														
Pressure regulators LRB/LRBS	Micro	-				■	■	■	-	-	-	-	-	lrb
	Mini	-	-	-	■	■	■	-	-	-	-	-	-	
	Midi	-	-	-	■	■	■	-	-	-	-	-	-	
	Maxi	-	-											
Pressure regulator manifolds LRB-K	Micro	-												lrb
	Mini	-	-	-	■	■	-	-	-	-	-	-	-	
	Midi	-	-	-	■	■	-	-	-	-	-	-	-	
	Maxi	-	-											
Lubricators LOE	Mini	■	-	-	■	-	-	-	-	-	-	-	-	6
	Midi	■	-	-	■	-	-	-	-	-	-	-	-	
	Maxi	■	-	-	■	-	-	-	-	-	-	-	-	
On/off valves HE	Micro	-												he
	Mini	-	-	-	■	■	-	-	-	-	-	-	-	
	Midi	-	-	-	■	■	-	-	-	-	-	-	-	
	Maxi	-	-	-	■	■	-	-	-	-	-	-	-	
On/off valves HEE	Micro	-												hee
	Mini	-	-	-	■	-	-	■	■	■	-	-	-	
	Midi	-	-	-	■	-	-	■	■	■	-	-	-	
	Maxi	-	-	-	■	-	-	■	■	■	-	-	-	
On/off valves HEP	Micro	-												hep
	Mini	-	-	-	■	-	-	-	-	-	-	-	-	
	Midi	-	-	-	■	-	-	-	-	-	-	-	-	
	Maxi	-	-	-	■	-	-	-	-	-	-	-	-	
Soft-start valves HEL	Micro	-												hel
	Mini	-	-	-	■	-	-	-	-	-	-	-	-	
	Midi	-	-	-	■	-	-	-	-	-	-	-	-	
	Maxi	-	-	-	■	-	-	-	-	-	-	-	-	
Membrane air dryers LDM1	Micro	-												ldm1
	Mini	-												
	Midi	-												
	Maxi	■	-	-	■	-	-	-	-	-	-	-	-	
Branching modules FRM	Micro	-												frm
	Mini	-	-	-	■	-	-	-	-	-	■	■		
	Midi	-	-	-	■	-	-	-	-	-	■	■		
	Maxi	-	-	-	■	-	-	-	-	-	■	■		
Distributor block FRZ	Mini	-	-	-	■	-	-	-	-	-	-	-	-	frz
	Midi	-	-	-	■	-	-	-	-	-	-	-	-	
	Maxi	-	-	-	■	-	-	-	-	-	-	-	-	

Peripherals overview

Mini/Midi/Maxi

Individual unit with connecting plates

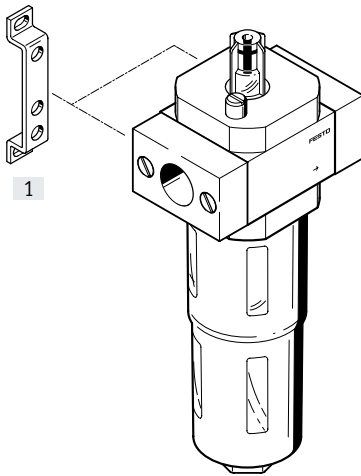

Individual unit without connecting plates, for service unit combination

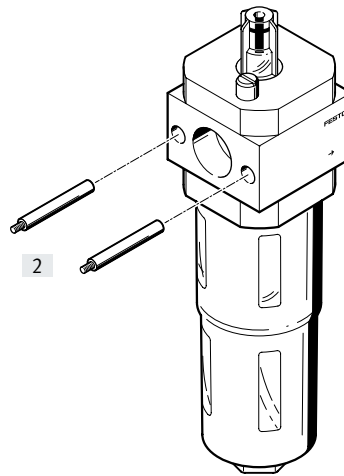

Mounting attachments and accessories

		Single device		Combination		→ Page/Internet
		With connecting plates	Without connecting plates	With connecting plates	Without connecting plates	
[1]	Mounting bracket HFOE	■	–	■	–	hfoe-d
[2]	Threaded bolt (included in the scope of delivery) FRB	–	–	■	■	frb-d

Type codes

001	Series
LOE	Lubricator

002	Pneumatic connection
	None
1/8	Female thread G1/8
1/4	Female thread G1/4
3/8	Female thread G3/8
1/2	Female thread G1/2
3/4	Female thread G3/4
1	Female thread G1



003	Version
D	D series, metal

004	Size
MINI	Grid dimension 40 mm (without connecting plates)
MIDI	Grid dimension 55 mm (without connecting plates)
MAXI	Grid dimension 66 mm (without connecting plates)

Datasheet

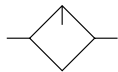
Function



-  - Flow rate
160 ... 9000 l/min
-  - Temperature range
-10 ... +60 °C
-  - Operating pressure
0 ... 16 bar



The proportional lubricator adds a precisely adjustable amount of oil to the compressed air.

The pressure drop that occurs when air flows through a Venturi nozzle is used to feed oil from the container to the drip cap.

From here, the oil drips into the air duct directly behind the proportional valve, where it is atomised. The amount of oil mist is proportional to the compressed air flow rate.

- Proportional lubricator with precision oil metering
- Reduces wear on drive units subject to high loads
- High flow rate
- Quick and easy oil top-up
- Sturdy metal housing
- Transparent oiler bowl with metal bowl guard

The following oils are recommended for Festo components:

Viscosity range to ISO 3448, ISO class VG 32
nuto32 mm²/s (= cSt) at 40 °C

- Festo special oil → page 13
- ARAL Vitam GF 32
- BP Energol HLP 32
- ESSO Nuto H 32
- Mobil DTE 24
- Shell Tellus Oil DO 32

General technical data			
Size	Mini	Midi	Maxi
Pneumatic connection 1, 2 ¹⁾	G1/8, G1/4, G3/8, - ²⁾	G1/4, G3/8, G1/2, G3/4, - ²⁾	G1/2, G3/4, G1, - ²⁾
Design	Proportional standard mist lubricator		
Type of mounting	Via accessories In-line installation		
Mounting position	Vertical ±5°		
Air purity class at the output	Compressed air to ISO 8573-1:2010 [7:4:4] Inert gases		
Bowl guard	Metal bowl guard		
Minimum flow rate for lubricator function [l/min]	3	8	10
Max. oil capacity [cm ³]	45	110	190

1) Connecting plates with threaded connection

2) Without connecting plates.

† Note: This product corresponds to ISO 1179-1 and ISO 228-1.

Datasheet

Standard nominal flow rate $q_{nN}^{1)}$ [l/min]										
Size	Mini			Midi			Maxi			
Pneumatic connection 1, 2	G1/8	G1/4	G3/8	G1/4	G3/8	G1/2	G3/4	G1/2	G3/4	G1
LOE	1300	2300	2700	2800	5500	6100	6300	8300	8400	9000

1) Measured at $p_1 = 6$ bar and $\Delta p = 1$ bar.

Operating and environmental conditions	
Operating pressure [bar]	0 ... 16
Operating medium	Compressed air to ISO 8573-1:2010 [7:4:4] Inert gases
Note on the operating/ pilot medium	Lubricated operation possible (in which case lubricated operation will always be required)
Ambient temperature [°C]	-10 ... +60
Temperature of medium [°C]	-10 ... +60
Storage temperature [°C]	-10 ... +60
Corrosion resistance class CRC ¹⁾	2

1) Further information www.festo.com/x/topic/crc

Weight [g]				
Size	Mini	Midi	Maxi	
			Connection G1/2, G3/4	Connection G1
LOE	270	630	1100	1200

Materials

Sectional view

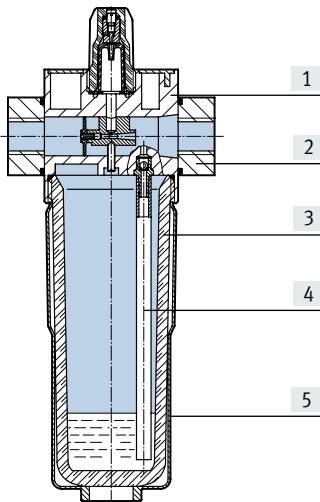

[1] Housing	Die-cast zinc/aluminium
[2] Connecting plates	Die-cast zinc/aluminium
[3] Bowl	PC
[4] Tubing	PU
[5] Metal bowl guard	Wrought aluminium alloy
- Seals	NBR
Note on materials	RoHS-compliant
PWIS conformity	VDMA24364-B1/B2-L

Datasheet

Standard flow rate q_n as a function of differential pressure Δp_{1-2}

LOE-1/4-D-MINI

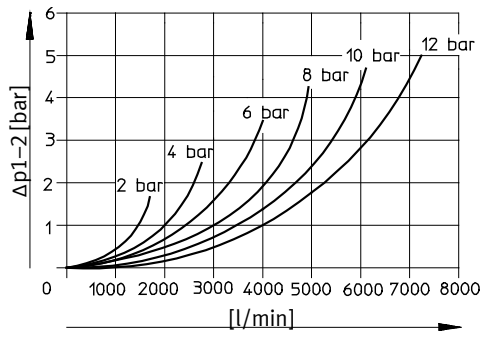

LOE-1/2-D-MIDI

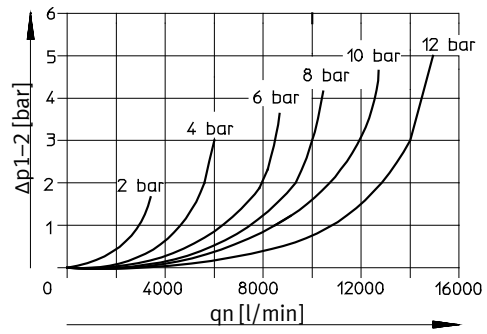

LOE-1-D-MAXI

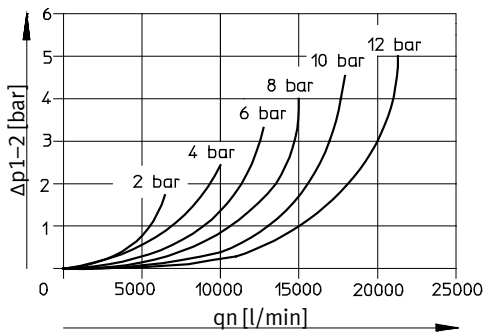

Datasheet

Dimensions

Download CAD data → www.festo.com

Connecting plates with threaded connection

Without connecting plates

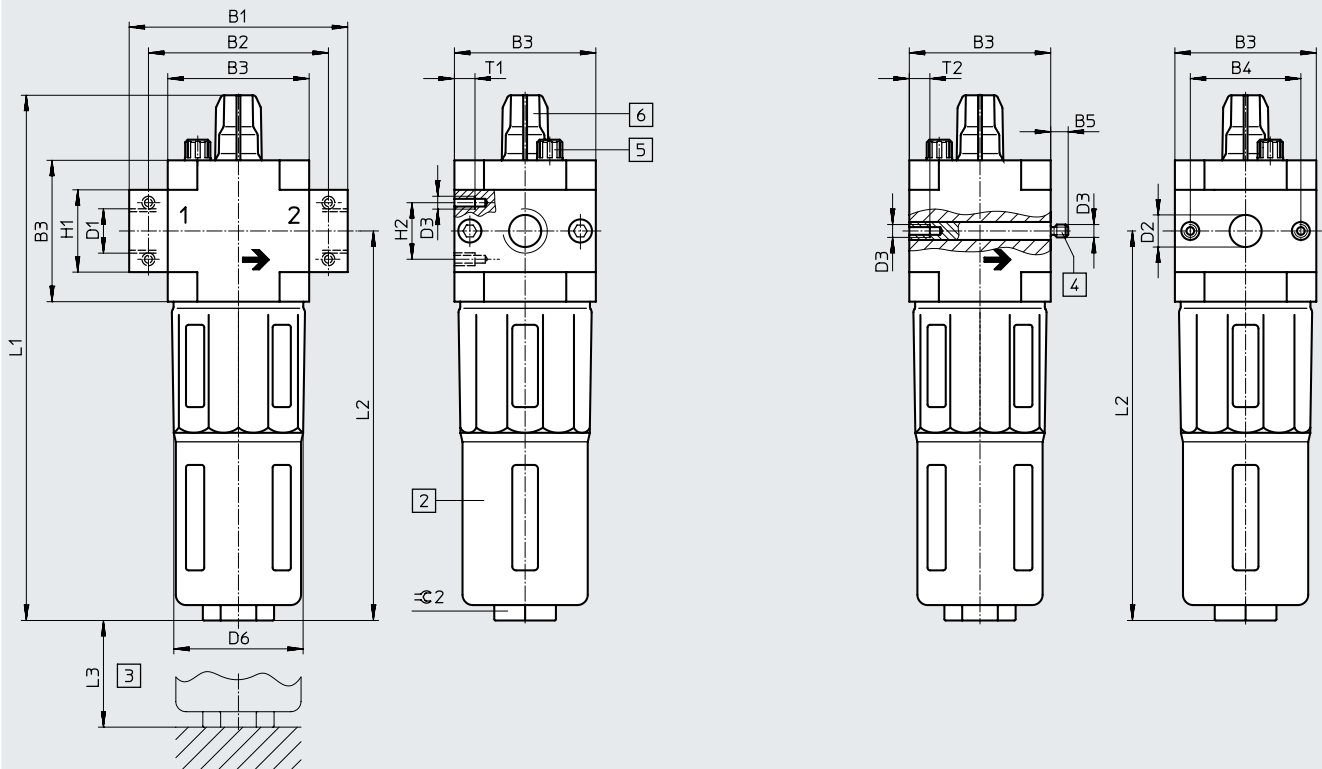

- [2] Metal bowl guard
- [3] Installation dimension
- [4] Threaded bolt (exchangeable)
- [5] Bleed screw for oil reservoir
- [6] Oil adjusting screw
- Flow direction

Type	B1	B2	B3	B4	B5	D1	D2 ∅	D3	D6 ∅	H1	H2	L1	L2	L3	T1	T2	⊖ 2
Mini																	
LOE-1/8-D-MINI	64	52	40	30	-	G1/8	-	M4	38	20	11	169	124	100	7	-	22
LOE-1/4-D-MINI						G1/4											
LOE-3/8-D-MINI	70					G3/8											
LOE-D-MINI	-	-			5.8	-	11			-	-				-	10	
Midi																	
LOE-1/4-D-MIDI	85	70	55	43	-	G1/4	-	M5	52	32	22	204	151	120	8	-	24
LOE-3/8-D-MIDI						G3/8											
LOE-1/2-D-MIDI						G1/2											
LOE-3/4-D-MIDI						G3/4											
LOE-D-MIDI	-	-			6.8	-	24			-	-				-	11	
Maxi																	
LOE-1/2-D-MAXI	96	80	66	46	-	G1/2	-	M5	65	32	22	228	170	150	8	-	24
LOE-3/4-D-MAXI						G3/4				40							
LOE-1-D-MAXI	116	91				G1				-	-				-	11	
LOE-D-MAXI	-	-			6.8	-	30			-	-				-	11	

† Note: This product corresponds to ISO 1179-1 and ISO 228-1.

Datasheet

Ordering data			
Size	Connection	Part no.	Type
Without connecting plates			
Mini	–	192575	LOE-D-MINI
Midi	–	192576	LOE-D-MIDI
Maxi	–	192577	LOE-D-MAXI
Connecting plates with threaded connection			
Mini	G1/8	159620	LOE-1/8-D-MINI
	G1/4	159621	LOE-1/4-D-MINI
	G3/8	162680	LOE-3/8-D-MINI
Midi	G1/4	186479	LOE-1/4-D-MIDI
	G3/8	159586	LOE-3/8-D-MIDI
	G1/2	159587	LOE-1/2-D-MIDI
	G3/4	162681	LOE-3/4-D-MIDI
Maxi	G1/2	186480	LOE-1/2-D-MAXI
	G3/4	159622	LOE-3/4-D-MAXI
	G1	159623	LOE-1-D-MAXI

Accessories

Special oil

**Ordering data**

Scope of delivery

Part no.

Type

1 litre

152811

OFSW-32