

# Xtreme-Wrap<sup>TM</sup> Electric Heated Hose

3A7524E

EN

*For use with Graco plural component proportioners equipped with Electric Heated Hose Temperature Controller in hazardous (classified) and non-hazardous locations. Not approved for use in European explosive atmosphere locations.*

*For professional use only.*

See page 2 for model information and agency approvals including maximum working pressure.



## Important Safety Instructions

Read all warnings and instructions in this manual, your proportioner manual, and the Heated Hose Controller manual before using the equipment. Save these instructions.

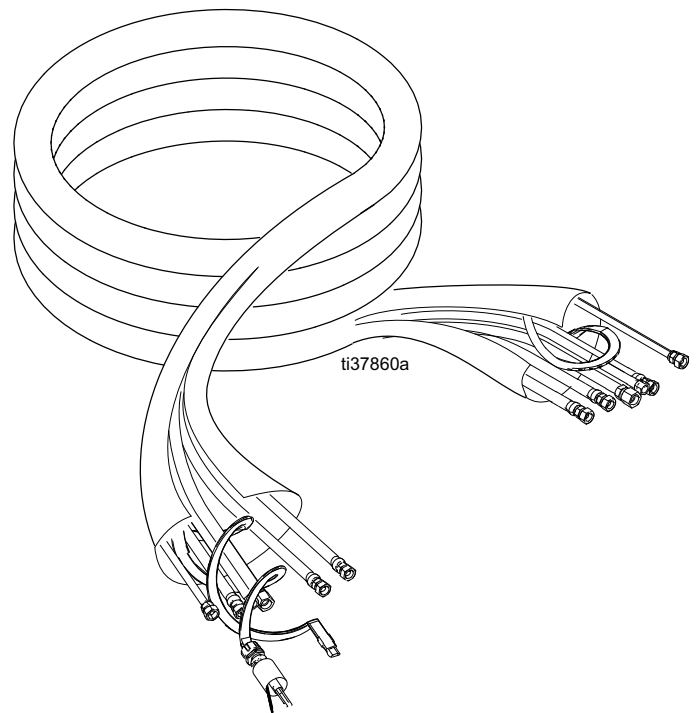

# Contents

<b>Contents</b> .....	<b>2</b>	<b>Installation</b> .....	<b>24</b>
<b>Related Manuals</b> .....	<b>2</b>	Grounding.....	24
<b>Models</b> .....	<b>3</b>	Connect the Fluid Hose.....	24
<b>Components and Approvals</b> .....	<b>3</b>	Connect the Heat Cable for Non-Hazardous Locations.....	25
<b>Warnings</b> .....	<b>4</b>	Connect the Heat Cable for Hazardous Locations.....	26
<b>Important Isocyanate (ISO) Information</b> .....	<b>7</b>	Hazardous Location 50-150 ft Hoses.....	27
Keep Components A and B Separate.....	7	Hazardous Location 200 ft Hoses.....	28
Moisture Sensitivity of Isocyanates.....	8	Connect the Temperature Sensor.....	29
Changing Materials.....	8	<b>Operation</b> .....	<b>30</b>
<b>Xtreme-Wrap Electric Heated Hose Bundle</b> .....	<b>9</b>	Pressure Relief Procedure.....	30
Hose selection for Feeding a Remote Mix Manifold.....	9	Change Temperature Units.....	31
<b>Component Identification</b> .....	<b>10</b>	Change Temperature Setpoint.....	31
50 - 150 ft (15 - 45 m) Hose.....	10	Change Temperature Units.....	31
200 ft (60 m) Hose.....	11	Change Temperature Setpoint.....	31
<b>Typical Installation</b> .....	<b>12</b>	<b>Troubleshooting</b> .....	<b>32</b>
Non-Hazardous Location System (Shown with		Temperature Control Error Codes.....	34
Heated Hose Controller Kit 18C175).....	12	<b>Repair</b> .....	<b>35</b>
Non-Hazardous Location 240V Systems.....	14	Turn Off Power to the Equipment.....	35
Non-Hazardous Location 480V (XP Systems only).....	16	Disconnect the Heater Cable.....	35
Non-Hazardous Location 480V (XM Systems only).....	18	Replace Hoses.....	35
Hazardous Location Systems for		Heat Cable Installation.....	35
50 - 150 ft (15 - 45 m) Hoses.....	20	<b>Repair Parts</b> .....	<b>37</b>
Hazardous Location Systems for		Part Number Example: HH7531X.....	37
200 ft (60 m) Hoses.....	22	<b>Recycling and Disposal</b> .....	<b>39</b>
		End of Product Life.....	39
		<b>California Proposition 65</b> .....	<b>39</b>
		<b>Technical Specifications</b> .....	<b>39</b>
		<b>Graco Standard Warranty</b> .....	<b>40</b>

## Related Manuals

Manual in English	Description
312359	XM™ Plural-Component Sprayers
3A6283	XPs-hf™ Proportioners
3A7682	Electric Heated Hose Temperature Controller
3A7523	Junction Box for XPs and XMs Proportioners
3A7670	Remote Recirculation Manifold

# Models



7250 psi (500 bar) Heated Hoses†											
HH	7	X		X		X			X		
First and Second Digit	Third Digit	Fourth Digit		Fifth Digit		Sixth Digit			Seventh Digit		
Type	Maximum Working Pressure psi (mPa, bar)	A Diameter		B Diameter			B2 Hose‡	Recirculation Hose ❖	Length		
<b>Xtreme-Wrap Electric Heated Hose</b>	7250 (50, 500)	5	1/2 in.	5	1/2 in.	1			5	50 ft	
		3	3/8 in.	3	3/8 in.	2		✓		X	100 ft
		2	1/4 in.	3	✓			Y	150 ft		
					4	✓	✓	Z	200 ft		

† All heated hose bundles include 1/4 in. solvent hose.

‡ Only available as 1/2 in A x 3/8 in. B x 1/4 in. B2 bundle.





❖ A and B recirculation lines are 3/8 in.

## Components and Approvals



Component	Agency Approval
Heat Cable, 16 AWG, 8 watts/ft	  38141 Class 1, Division 1
Power/End Seal Connection	 38141 Class 1, Division 2*
Type T Thermocouple	Simple apparatus in accordance with UL 60079-11, clause 5.7
* In order to comply with a Class 1, Division 1 requirement, appropriate wiring must be completed. See <b>Connect the Heat Cable for Hazardous Locations</b> on page 26.	

# Warnings

The following warnings are for the setup, use, grounding, maintenance, and repair of this equipment. The exclamation point symbol alerts you to a general warning and the hazard symbols refer to procedure-specific risks. When these symbols appear in the body of this manual or on warning labels, refer back to these Warnings. Product-specific hazard symbols and warnings not covered in this section may appear throughout the body of this manual where applicable.

 <h2 style="margin: 0;">WARNING</h2>	
   	<p><b>FIRE AND EXPLOSION HAZARD</b></p> <p>Flammable fumes, such as solvent and paint fumes, in <b>work area</b> can ignite or explode. Paint or solvent flowing through the equipment can cause static sparking. To help prevent fire and explosion:</p> <ul style="list-style-type: none"> <li>• Eliminate all ignition sources; such as pilot lights, cigarettes, portable electric lamps, and plastic drop cloths (potential static sparking).</li> <li>• Use equipment only in well-ventilated area.</li> <li>• Ground all equipment in the work area. See <b>Grounding</b> instructions.</li> <li>• Never spray or flush solvent at high pressure.</li> <li>• Keep work area free of debris, including solvent, rags and gasoline.</li> <li>• Do not plug or unplug power cords, or turn power or light switches on or off when flammable fumes are present.</li> <li>• Use only grounded hoses.</li> <li>• Hold gun firmly to side of grounded pail when triggering into pail. Do not use pail liners unless they are anti-static or conductive.</li> <li>• <b>Stop operation immediately</b> if static sparking occurs or you feel a shock. Do not use equipment until you identify and correct the problem.</li> <li>• Keep a working fire extinguisher in the work area.</li> </ul>
 	<p><b>ELECTRIC SHOCK HAZARD</b></p> <p>The hoses must be grounded. Improper grounding, set-up, or usage of hoses can cause electric shock.</p> <ul style="list-style-type: none"> <li>• Turn off and disconnect power before installing or servicing hoses.</li> <li>• Connect only to grounded power source.</li> <li>• All electrical wiring must be done by a qualified electrician and comply with all local codes and regulations.</li> <li>• Never cut or puncture a hose cover.</li> <li>• Do not expose to rain. Store indoors.</li> </ul>
  	<p><b>SKIN INJECTION HAZARD</b></p> <p>High-pressure fluid from hose leaks, or ruptured components will pierce skin. This may look like just a cut, but it is a serious injury that can result in amputation. <b>Get immediate surgical treatment.</b></p> <ul style="list-style-type: none"> <li>• Inspect hose before each use for cuts, bulges, kinks or any other damage.</li> <li>• Replace damaged hose immediately.</li> <li>• Replace hoses proactively at regular intervals based on your operating conditions.</li> <li>• Tighten all fluid connections before operating the equipment.</li> <li>• Keep clear of leaks.</li> <li>• Do not stop or deflect leaks with your hand, body, glove, or rag.</li> <li>• Never exceed hose Maximum Pressure or Temperature ratings.</li> <li>• Only use chemicals that are compatible with hose materials. See <b>Technical Specifications</b> in this manual. Read Safety Data Sheets (SDSs) and fluid and solvent manufacturer's recommendations.</li> <li>• Follow the Pressure Relief Procedure when you stop spraying/dispensing and before cleaning, checking, or servicing equipment.</li> </ul>

# ! WARNING

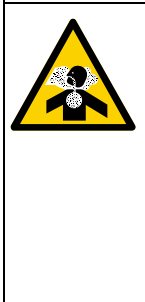
	<p><b>THERMAL EXPANSION HAZARD</b></p> <p>Fluids subjected to heat in confined spaces, including hoses, can create a rapid rise in pressure due to the thermal expansion. Over-pressurization can result in equipment rupture and serious injury.</p> <ul style="list-style-type: none"> <li>• Open a valve to relieve the fluid expansion during heating.</li> <li>• Replace hoses proactively at regular intervals based on your operating conditions.</li> </ul>
	<p><b>BURN HAZARD</b></p> <p>Equipment surfaces and fluid that is heated can become very hot during operation. To avoid severe burns:</p> <ul style="list-style-type: none"> <li>• Do not touch hot fluid or equipment.</li> </ul>
	<p><b>TOXIC FLUID OR FUMES HAZARD</b></p> <p>Toxic fluids or fumes can cause serious injury or death if splashed in the eyes or on skin, inhaled or swallowed.</p> <ul style="list-style-type: none"> <li>• Read Safety Data Sheets (SDSs) for handling instructions and to know the specific hazards of the fluids you are using, including the effects of long-term exposure.</li> <li>• When spraying, servicing equipment, or when in the work area, always keep work area well-ventilated and always wear appropriate personal protective equipment. See <b>Personal Protective Equipment</b> warnings in this manual.</li> <li>• Store hazardous fluid in approved containers, and dispose of it according to applicable guidelines.</li> </ul>

# ! WARNING



## EQUIPMENT MISUSE HAZARD

Misuse can cause death or serious injury.

- Do not operate the unit when fatigued or under the influence of drugs or alcohol.
- Do not exceed the maximum working pressure or temperature rating of the lowest rated system component. See **Technical Specifications** in all equipment manuals.
- Use fluids and solvents that are compatible with equipment wetted parts. See **Technical Specifications** in all equipment manuals. Read fluid and solvent manufacturer's warnings. For complete information about your material, request Safety Data Sheets (SDSs) from distributor or retailer.
- Do not leave the work area while equipment is energized or under pressure.
- Turn off all equipment and follow the **Pressure Relief Procedure** when equipment is not in use.
- Check equipment daily. Repair or replace worn or damaged parts immediately with genuine manufacturer's replacement parts only.
- Do not alter or modify equipment. Alterations or modifications may void agency approvals and create safety hazards.
- Make sure all equipment is rated and approved for the environment in which you are using it.
- Use equipment only for its intended purpose. Call your distributor for information.
- Route hoses and cables away from traffic areas, sharp edges, moving parts, and hot surfaces.
- Do not kink or over bend hoses or use hoses to pull equipment.
- Keep children and animals away from work area.
- Comply with all applicable safety regulations.



## PERSONAL PROTECTIVE EQUIPMENT

Always wear appropriate personal protective equipment and cover all skin when spraying, servicing equipment, or when in the work area. Protective equipment helps prevent serious injury, including long-term exposure; inhalation of toxic fumes, mists or vapors; allergic reaction; burns; eye injury and hearing loss. This protective equipment includes but is not limited to:

- A properly fitting respirator, which may include a supplied-air respirator, chemically impermeable gloves, protective clothing and foot coverings as recommended by the fluid manufacturer and local regulatory authority.
- Protective eyewear and hearing protection.

# Important Isocyanate (ISO) Information

Isocyanates (ISO) are catalysts used in two component materials.



Spraying or dispensing fluids that contain isocyanates creates potentially harmful mists, vapors, and atomized particulates.

- Read and understand the fluid manufacturer's warnings and Safety Data Sheets (SDSs) to know specific hazards and precautions related to isocyanates.
- Use of isocyanates involves potentially hazardous procedures. Do not spray with this equipment unless you are trained, qualified, and have read and understood the information in this manual and in the fluid manufacturer's application instructions and SDSs.
- Use of incorrectly maintained or mis-adjusted equipment may result in improperly cured material. Equipment must be carefully maintained and adjusted according to instructions in the manual.
- To prevent inhalation of isocyanate mists, vapors, and atomized particulates, everyone in the work area must wear appropriate respiratory protection. Always wear a properly fitting respirator, which may include a supplied-air respirator. Ventilate the work area according to instructions in the fluid manufacturer's SDSs.
- Avoid all skin contact with isocyanates. Everyone in the work area must wear chemically impermeable gloves, protective clothing and foot coverings as recommended by the fluid manufacturer and local regulatory authority. Follow all fluid manufacturer recommendations, including those regarding handling of contaminated clothing. After spraying, wash hands and face before eating or drinking.

## Keep Components A and B Separate



Cross-contamination can result in cured material in fluid lines which could cause serious injury or damage equipment. To prevent cross-contamination:

- **Never** interchange component A and component B wetted parts.
- Never use solvent on one side if it has been contaminated from the other side.

## Moisture Sensitivity of Isocyanates

Exposure to moisture (such as humidity) will cause ISO to partially cure, forming small, hard, abrasive crystal that become suspended in the fluid. Eventually a film will form on the surface and the ISO will begin to gel, increasing in viscosity.

### NOTICE

Partially cured ISO will reduce performance and the life of all wetted parts.

- Always use a sealed container with a desiccant dryer in the vent, or a nitrogen atmosphere. **Never** store ISO in an open container.
- Keep the ISO pump wet cup or reservoir (if installed) filled with appropriate lubricant. The lubricant creates a barrier between the ISO and the atmosphere.
- Use only moisture-proof hoses compatible with ISO.
- Never use reclaimed solvents, which may contain moisture. Always keep solvent containers closed when not in use.
- Always lubricate threaded parts with an appropriate lubricant when reassembling.

**NOTE:** The amount of film formation and rate of crystallization varies depending on the blend of ISO, the humidity, and the temperature.

## Changing Materials

### NOTICE

Changing the material types used in your equipment requires special attention to avoid equipment damage and downtime.

- When changing materials, flush the equipment multiple times to ensure it is thoroughly clean.
- Always clean the fluid inlet strainers after flushing.
- Check with your material manufacturer for chemical compatibility.
- When changing between epoxies and urethanes or polyureas, disassemble and clean all fluid components and change hoses. Epoxies often have amines on the B (hardener) side. Polyureas often have amines on the B (resin) side.



# Xtreme-Wrap Electric Heated Hose Bundle

The heated hose maintains the temperature set-point while spraying. All bundles have marked material hoses, “A” and “B”, with a solvent hose wrapped in an insulated/protective wrap. Optional configurations have an additional “B” hose and/or recirculation hoses for recirculating material.

The hose bundles are available in 50 ft (15 m) lengths up to 200 ft (60 m). See **Models**, page 3.

## Hose selection for Feeding a Remote Mix Manifold

Hoses should be sized to match the hose volume ratio to the mix ratio. The hose size should also allow for minimum pressure drop on the major volume side to meet your flow requirements.

### Volume Ratio of “A” to “B” Hose

Mix Ratio	Hose Selection “A” x “B”	Volume Ratio
1:1	1/2 x 1/2	1.00:1
	3/8 x 3/8	
2:1	1/2 x 3/8	1.78:1
3:1	3/8 x 1/4	2.25:1
4:1	1/2 x 1/4	4.00:1

# Component Identification

## 50 - 150 ft (15 - 45 m) Hose

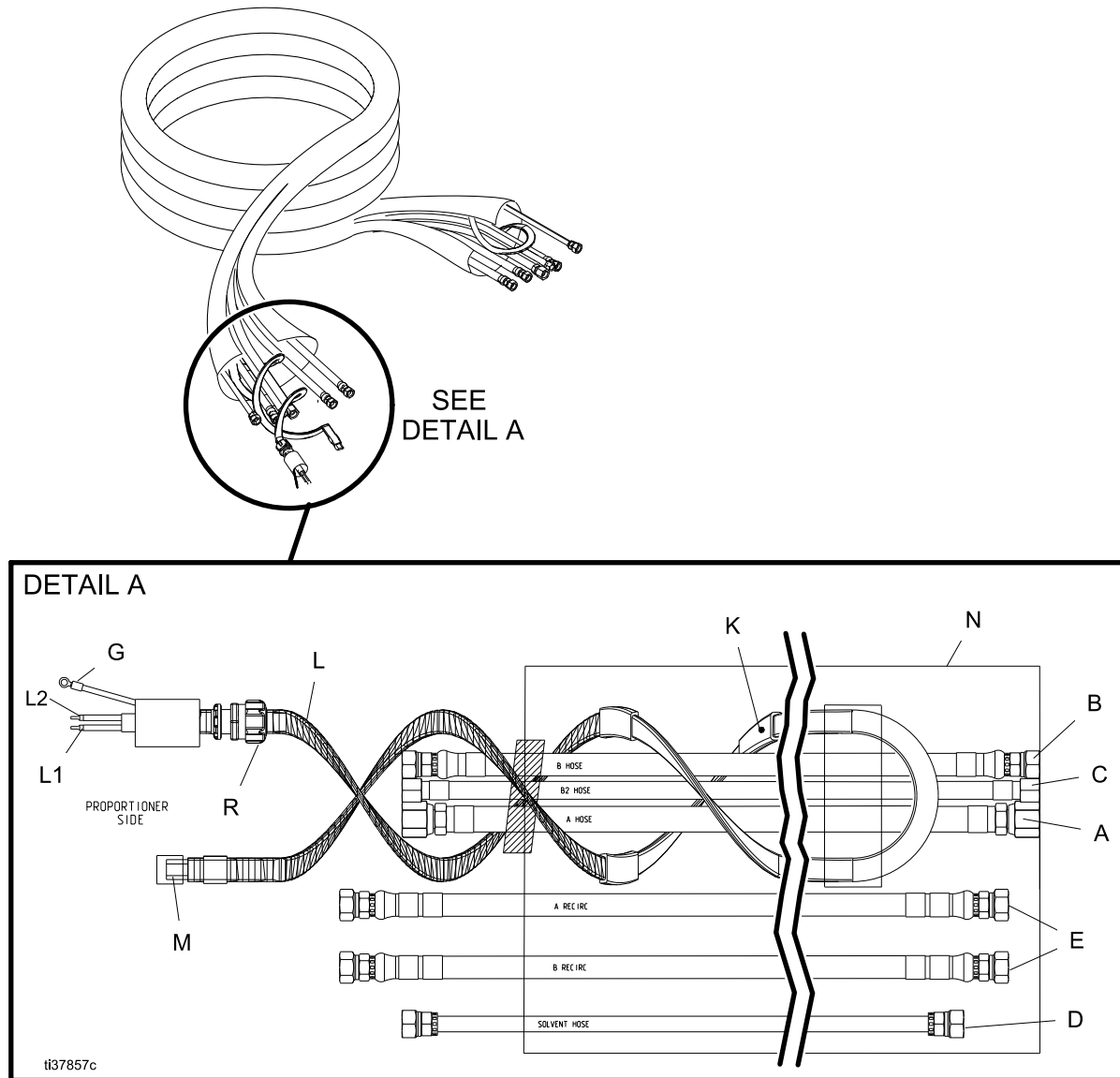

**FIG. 1: Component Identification for 50 - 150 ft (15 - 45 m) Hose**

Ref.	Description	Ref.	Description
A	"A" Material Hose	K	Temperature Sensor Band
B	"B" Material Hose	L1	Power Lead
C	"B2" Material Hose (optional)	L2	Power Lead
D	Solvent Hose	M	Heat Cable End Seal
E	Recirculation Hose (optional)	N	Xtreme-Wrap
G	Ground Wire	R	Heat Cable Strain Relief
L	Heat Cable		

# 200 ft (60 m) Hose

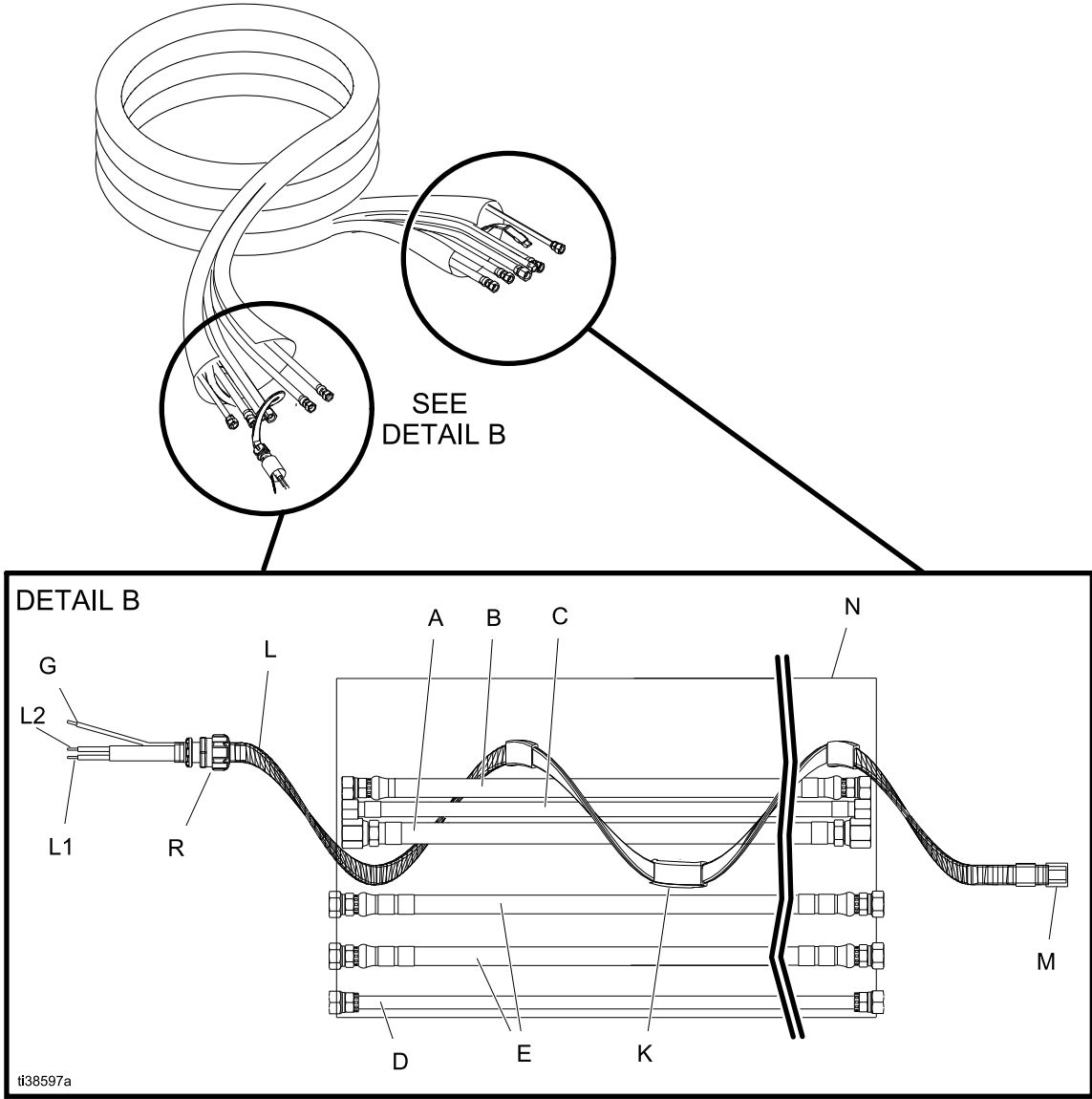
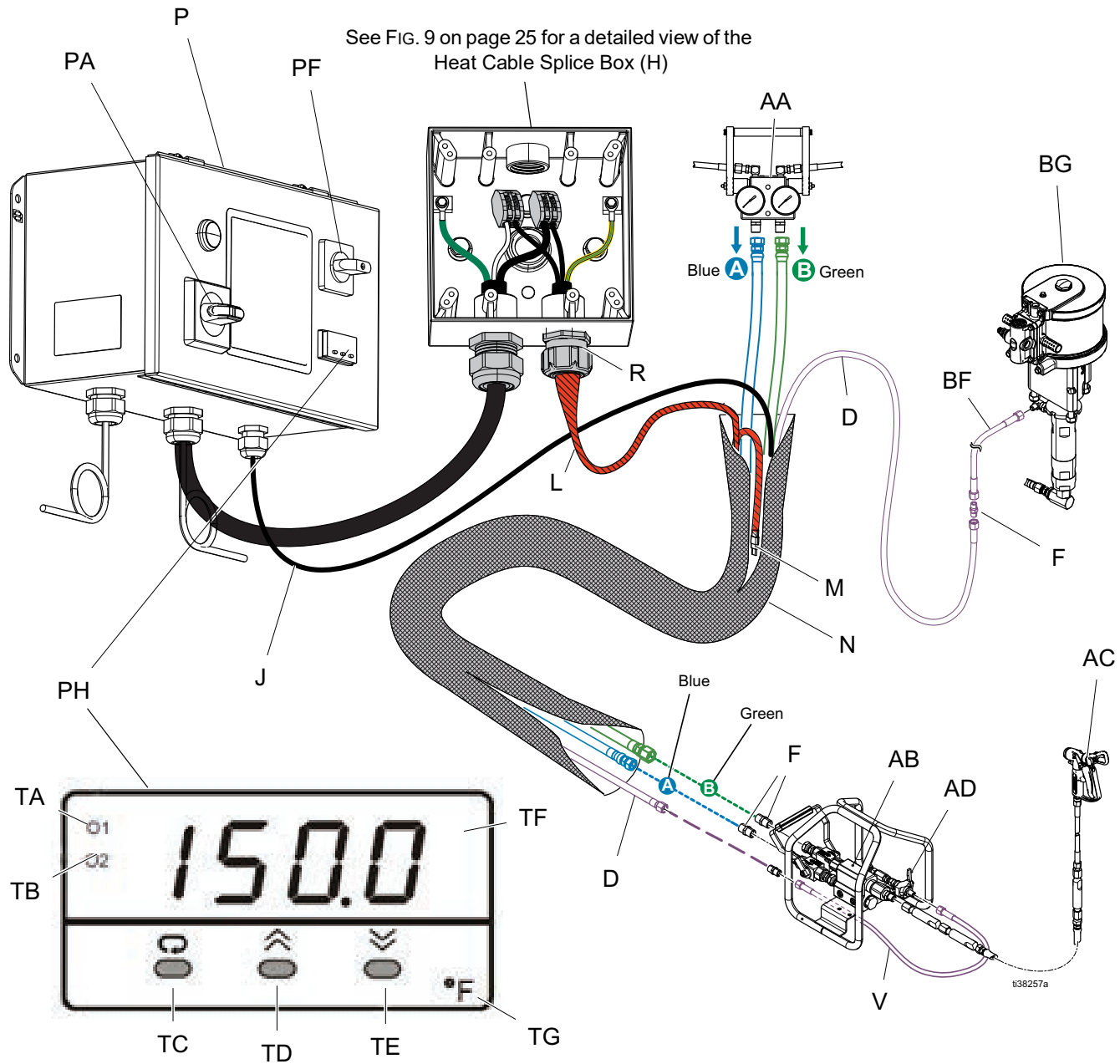

FIG. 2: Component Identification for 200 ft (60 m) Hose

Ref.	Description	Ref.	Description
A	"A" Material Hose	L	Heat Cable
B	"B" Material Hose	L1	Power Lead
C	"B2" Material Hose (optional)	L2	Power Lead
D	Solvent Hose	M	Heat Cable End Seal
E	Recirculation Hose (optional)	N	Xtreme-Wrap
G	Ground Wire	R	Heat Cable Strain Relief
K	Temperature Sensor Band		

# Typical Installation

## Non-Hazardous Location System (Shown with Heated Hose Controller Kit 18C175)



**FIG. 3: Typical Installation for Non-Hazardous Location System (Shown with Electric Heated Hose Controller)**

## Electric Heated Hose Controller 18C175 Installation

<b>Ref.</b>	<b>Description</b>
D	Solvent Hose
*F	Fitting Adapter
H	Heat Cable Splice Box
J	Temperature Sensing Probe
L	Heat Cable
M	Heat Cable End Seal
N	Xtreme-Wrap
P	Junction Box with Hose Temperature Controller
R	Heat Cable Strain Relief
*V	Solvent Hose Extension
AA	Recirculation Manifold
AB	Mix Manifold
AC	XTR Spray Gun
AD	Solvent Flush Valve
BF	Solvent Outlet Hose
BG	Solvent Pump
PA	Main Power Switch
PF	Hose Heater Switch
PH	Hose Temperature Controller
TA	Output 1 Indicator (ON when hose is heating)
TB	Output 2 Indicator (ON unless hose has overheated)
TC	Enter Button
TD	Arrow Up
TE	Arrow Down
TF	Display Screen
TG	Temperature Unit Indicator

*\* Parts included in Fittings Kit 25T264 (shipped loose with Heated hose Controller Kit)*



## Non-Hazardous Location 240V Systems

### Ref. Description

D	Solvent Hose
*F	Fitting Adapter
H	Heat Cable Splice Box
J	Temperature Sensing Probe
L	Heat Cable
M	Heat Cable End Seal
N	Xtreme-Wrap
P	Junction Box with Hose Temperature Controller
R	Heat Cable Strain Relief
*V	Solvent Hose Extension
AA	Recirculation Manifold
AB	Mix Manifold
AC	XTR Spray Gun
AD	Solvent Flush Valve
BF	Solvent Outlet Hose
BG	Solvent Pump
PA	Main Power Switch
PF	Hose Heater Switch
PH	Hose Temperature Controller
TA	Output 1 Indicator (ON when hose is heating)
TB	Output 2 Indicator (ON unless hose has overheated)
TC	Enter Button
TD	Arrow Up
TE	Arrow Down
TF	Display Screen
TG	Temperature Unit Indicator

*\* Parts included in Fittings Kit 25T264 (shipped loose with proportioner)*

# Non-Hazardous Location 480V (XP Systems only)

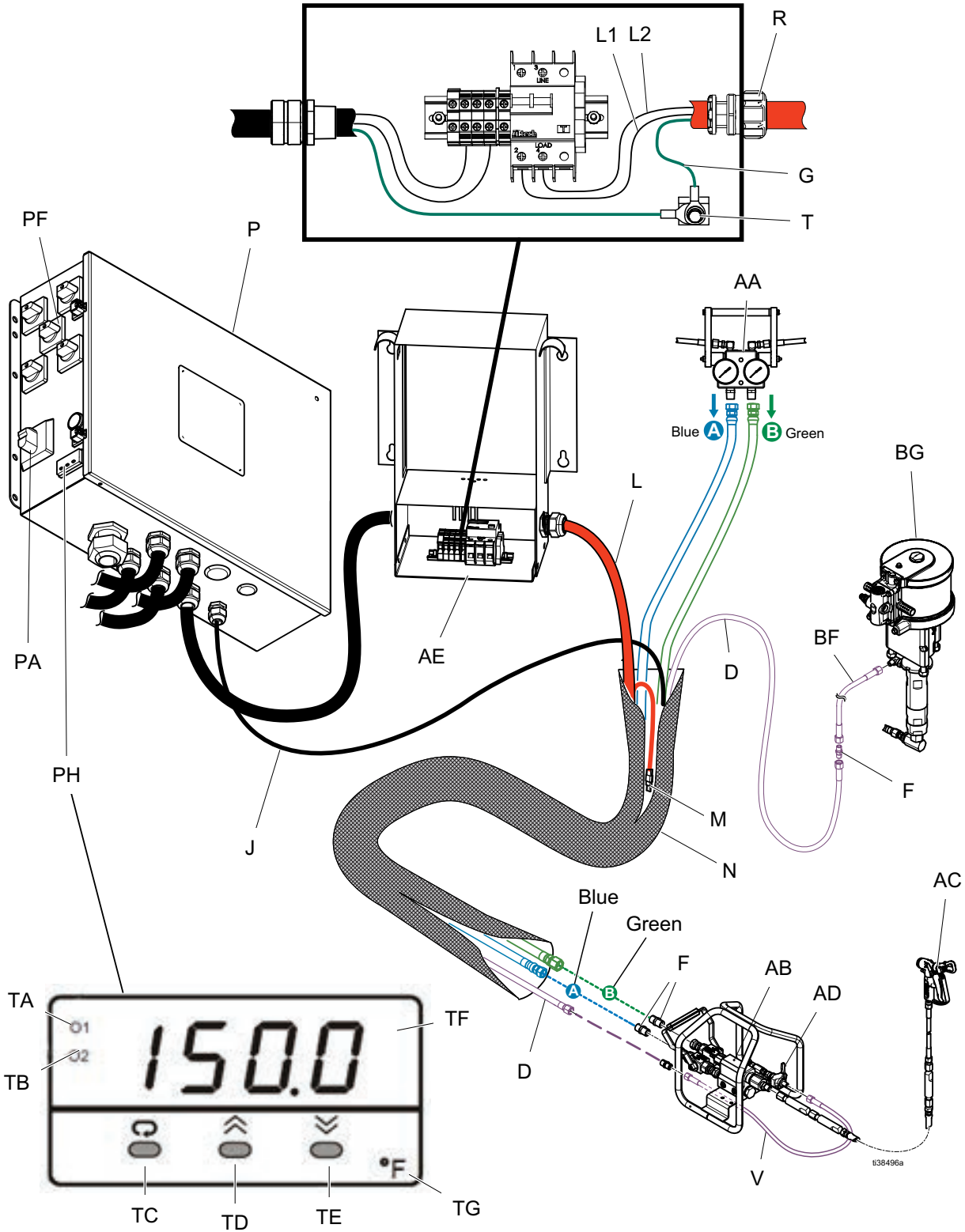

FIG. 5: Typical Installation for Non-Hazardous Location 480V Junction Box (XP Skid)



**Non-Hazardous Location 480V (XP Systems only)****Ref. Description**

D	Solvent Hose
*F	Fitting Adapter
G	Ground Wire
J	Temperature Sensing Probe
L	Heat Cable
M	Heat Cable End Seal
N	Xtreme-Wrap
P	Junction Box with Hose Temperature Controller
R	Heat Cable Strain Relief
T	Ground Terminal
*V	Solvent Hose Extension
AA	Recirculation Manifold
AB	Mix Manifold
AC	XTR Spray Gun
AD	Solvent Flush Valve
AE	Transformer
BF	Solvent Outlet Hose
BG	Solvent Pump
L1	Power Lead
L2	Power Lead
PA	Main Power Switch
PF	Hose Heater Switch
PH	Hose Temperature Controller
TA	Output 1 Indicator (ON when hose is heating)
TB	Output 2 Indicator (ON unless hose has overheated)
TC	Enter Button
TD	Arrow Up
TE	Arrow Down
TF	Display Screen
TG	Temperature Unit Indicator

*\* Parts included in Fittings Kit 25T264 (shipped loose with proportioner)*

# Non-Hazardous Location 480V (XM Systems only)

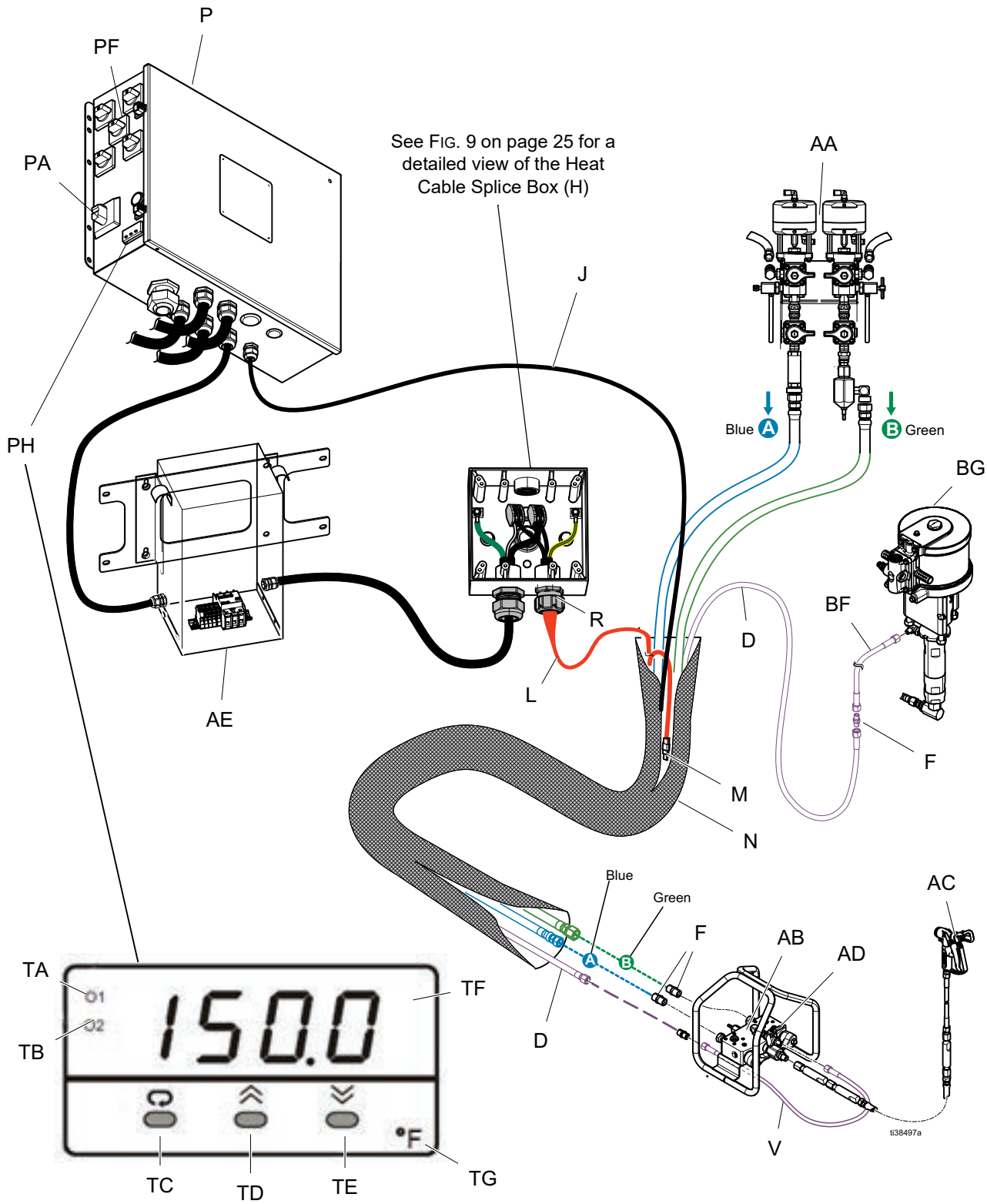

FIG. 6: Typical Installation for Non-Hazardous Location 480V Junction Box (XM Skid)

**Non-Hazardous Location 480V (XM Systems only)****Ref. Description**

D	Solvent Hose
*F	Fitting Adapter
H	Heat Cable Splice Box
J	Temperature Sensing Probe
L	Heat Cable
M	Heat Cable End Seal
N	Xtreme-Wrap
P	Junction Box with Hose Temperature Controller
R	Heat Cable Strain Relief
*V	Solvent Hose Extension
AA	Recirculation Manifold
AB	Mix Manifold
AC	XTR Spray Gun
AD	Solvent Flush Valve
AE	Transformer
BF	Solvent Outlet Hose
BG	Solvent Pump
PA	Main Power Switch
PF	Hose Heater Switch
PH	Hose Temperature Controller
TA	Output 1 Indicator (ON when hose is heating)
TB	Output 2 Indicator (ON unless hose has overheated)
TC	Enter Button
TD	Arrow Up
TE	Arrow Down
TF	Display Screen
TG	Temperature Unit Indicator

*\* Parts included in Fittings Kit 25T264 (shipped loose with proportioner)*

## Hazardous Location Systems for 50 - 150 ft (15 - 45 m) Hoses

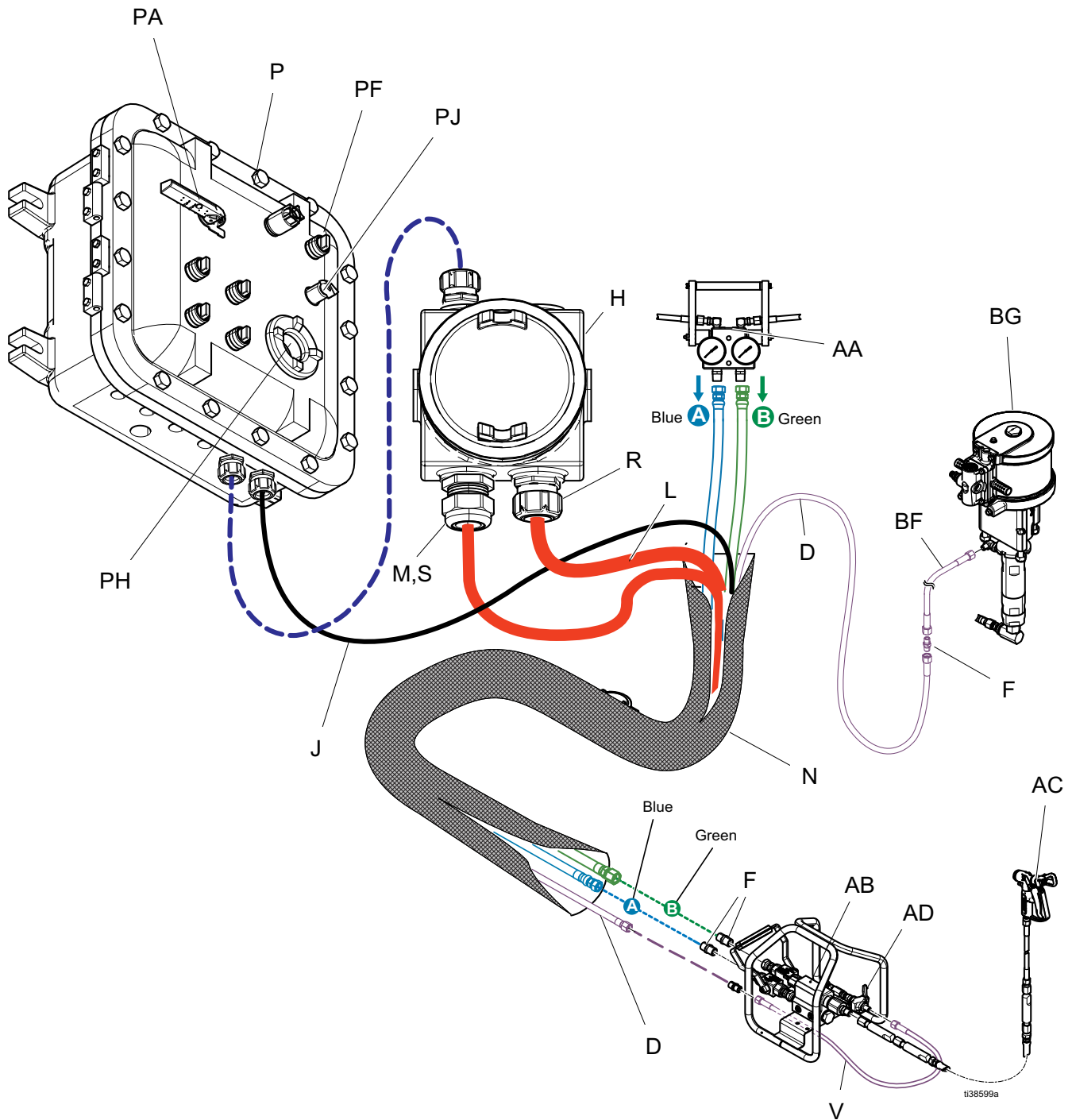

**FIG. 7: Typical Installation for Hazardous Locations Junction Box for 50 - 150 ft (15 - 45 m) Hoses**

**Hazardous Location Systems for 50 - 150 ft (15 - 45 m) Hoses****Ref. Description**

D	Solvent Hose
*F	Fitting Adapter
H	Heat Cable Splice Box
J	Temperature Sensing Probe
L	Heat Cable
M	Heat Cable End Seal (not shown, inside Heat Cable Splice Box)
N	Xtreme-Wrap
P	Junction Box with Hose Temperature Controller
R	Heat Cable Strain Relief
S	Strain Relief
*V	Solvent Hose Extension
AA	Recirculation Manifold
AB	Mix Manifold
AC	XTR Spray Gun
AD	Solvent Flush Valve
BF	Solvent Outlet Hose
BG	Solvent Pump
PA	Main Power Switch
PF	Hose Heater Switch
PH	Hose Temperature Controller
PJ	Hose Temperature Setpoint Adjustment

*\* Parts included in Fittings Kit 25T264 (shipped loose with proportioner)*



## Hazardous Location Systems for 200 ft (60 m) Hoses

### Ref. Description

D	Solvent Hose
*F	Fitting Adapter
H	Heat Cable Splice Box
J	Temperature Sensing Probe
L	Heat Cable
M	Heat Cable End Seal
N	Xtreme-Wrap
P	Junction Box with Hose Temperature Controller
R	Heat Cable Strain Relief
S	Strain Relief
*V	Solvent Hose Extension
W	Termination Leg Box
AA	Recirculation Manifold
AB	Mix Manifold
AC	XTR Spray Gun
AD	Solvent Flush Valve
BF	Solvent Outlet Hose
BG	Solvent Pump
PA	Main Power Switch
PF	Hose Heater Switch
PH	Hose Temperature Controller

\* Parts included in Fittings Kit 25T264 (*shipped loose with proportioner*)

# Installation

## Grounding



The equipment must be grounded to reduce the risk of static sparking and electric shock. Electric or static sparking can cause fumes to ignite or explode. Improper grounding can cause electric shock. Grounding provides an escape wire for the electric current.

Check the electrical resistance of hoses regularly. If total resistance from the end to the ground exceeds 29 megohms, replace the hose immediately.

Ground the hoses of the hose bundle through the fitting connections to a properly grounded proportioner. Connect the ground wire of the heat cable to the ground terminal inside the splice box. Follow **Connect the Heat Cable for Non-Hazardous Locations** on page 25. Follow **Connect the Heat Cable for Hazardous Locations** on page 26 for hazardous locations.

## Connect the Fluid Hose

1. Connect the “A” and “B” material hoses (A, B) to the outlets of the recirculation manifold (AA).

**NOTE:** Reducer fittings are required for 1/4 in. or 3/8 in. hoses (supplied in Heated Hose Fittings kit).

2. Connect the solvent outlet hose (BF) to the solvent hose (D).
3. Connect the “A” and “B” material hoses (A, B) to the inlet of the mix manifold (AB).

**NOTE:** Reducer fittings are required for 1/4 in. or 3/8 in. hoses (supplied in Heated Hose Fittings kit).

4. Connect the solvent hose extension (V) to the solvent hose (D).
5. Connect the solvent hose extension (V) to the solvent flush valve (AD).



## Connect the Heat Cable for Non-Hazardous Locations

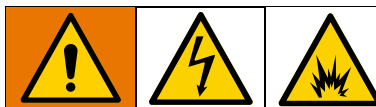

Improperly installed or connected equipment will create a hazardous condition and cause fire, explosion, or electric shock. All electrical wiring must be done by a qualified electrician and comply with all local codes and regulations.

1. Turn the main power switch (PA) to OFF.
2. Open the cover of the heat cable splice box (H).
 

**480V XP Skid Proportioners only:** Open the cover of the transformer (AE).
3. Open the Xtreme-Wrap (N) of the heated hose bundle.
4. Route the heat cable end seal (M) into the hose bundle. Note the location of the end seal (M). On 200 ft hoses (60 m), the end seal is on the gun side. On all other length hoses, the end seal is on the proportioner side.
5. Route the heat cable (L) to the heat cable splice box (H) and install the heat cable strain relief (R).
 

**480V XP Skid Proportioner:** Route to the transformer (AE) and install the strain relief.
6. Connect the ground wire (G) to the ground terminal (T).
7. Connect each of the power leads (L1, L2) to each splice connector (U) as shown. Reinstall the cover of the heat cable splice box (H).
 

**480V XP Skid proportioners only:** Connect L1 to CB2, connect L2 to CB4, and connect the ground wire (G) to ground terminal (T). See FIG. 5 on page 16.
8. Proceed to **Hazardous Location 50-150 ft Hoses**, page 27.

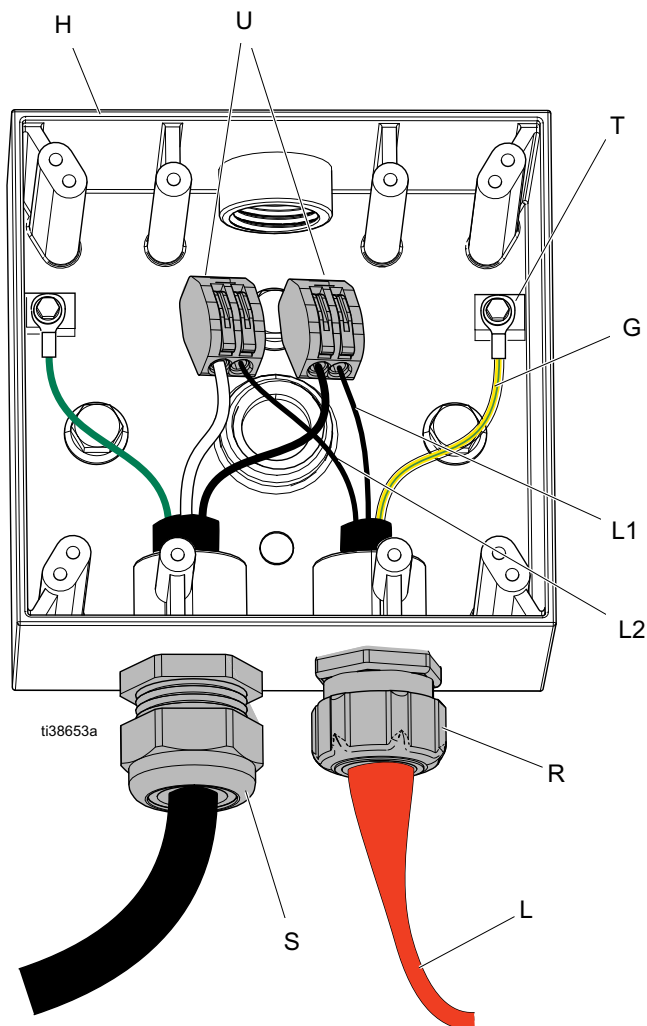

## Heat Cable Splice Box (H)



**FIG. 9: Heat Cable Splice Box (H)**

Ref.	Description
G	Ground Wire
R	Heat Cable Power Connection Leg with Strain Relief
S	Strain Relief
T	Ground Terminal
U	Splice Connectors
L	Heat Cable
L1	Power Lead
L2	Power Lead

## Connect the Heat Cable for Hazardous Locations

				
<p>Improperly installed or connected equipment will create a hazardous condition and cause fire, explosion, or electric shock. Follow all local regulations.</p> <p>If your system is intended for hazardous locations, you must have a qualified electrician connect the heat cable wiring. Make sure the wiring and installation comply with all codes and regulations for hazardous locations.</p>				

When an explosion-proof temperature controller is used, ensure the wiring, wiring connections, and electrical distribution panel all meet explosion-proof requirements.

All electrical wiring in the hazardous area must be encased in Class 1, Division 1, Groups C and D approved explosion-proof conduit. Follow all national, state, and local electrical codes. See the figures below for all connections between the heated hose and the heat cable splice box. See your junction box manual for wiring diagrams for all connections between the junction box and the heat cable splice box.

**Wiring Diagram - Hazardous Location  
50-150 ft Hoses**

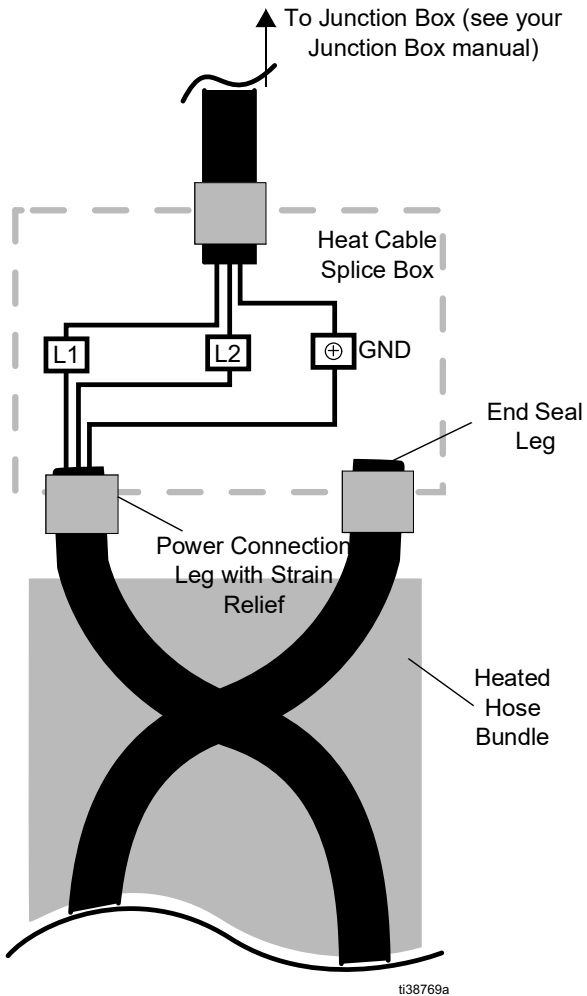

**Wiring Diagram - Hazardous Location 200 ft  
Hoses**

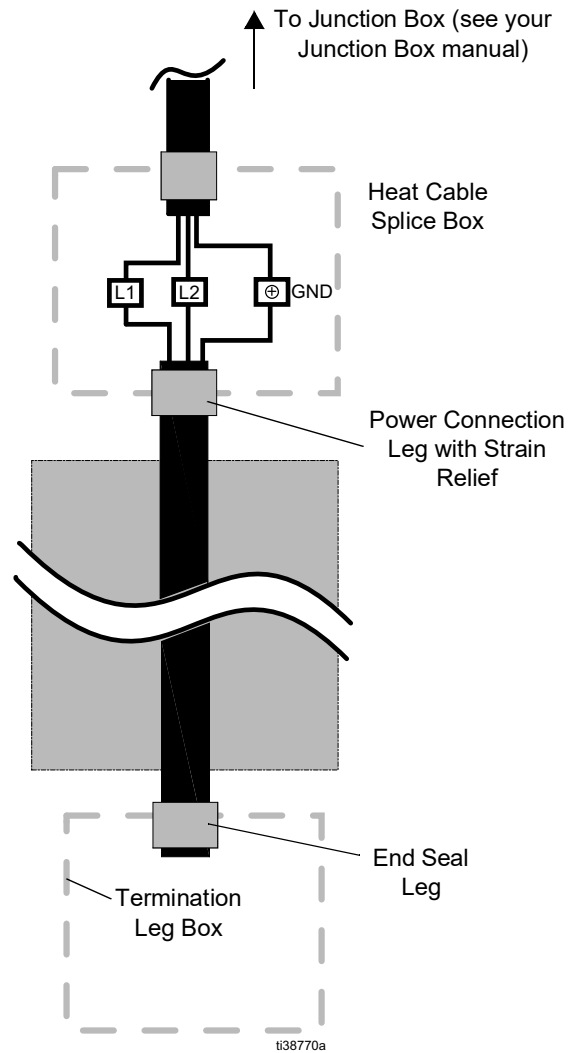

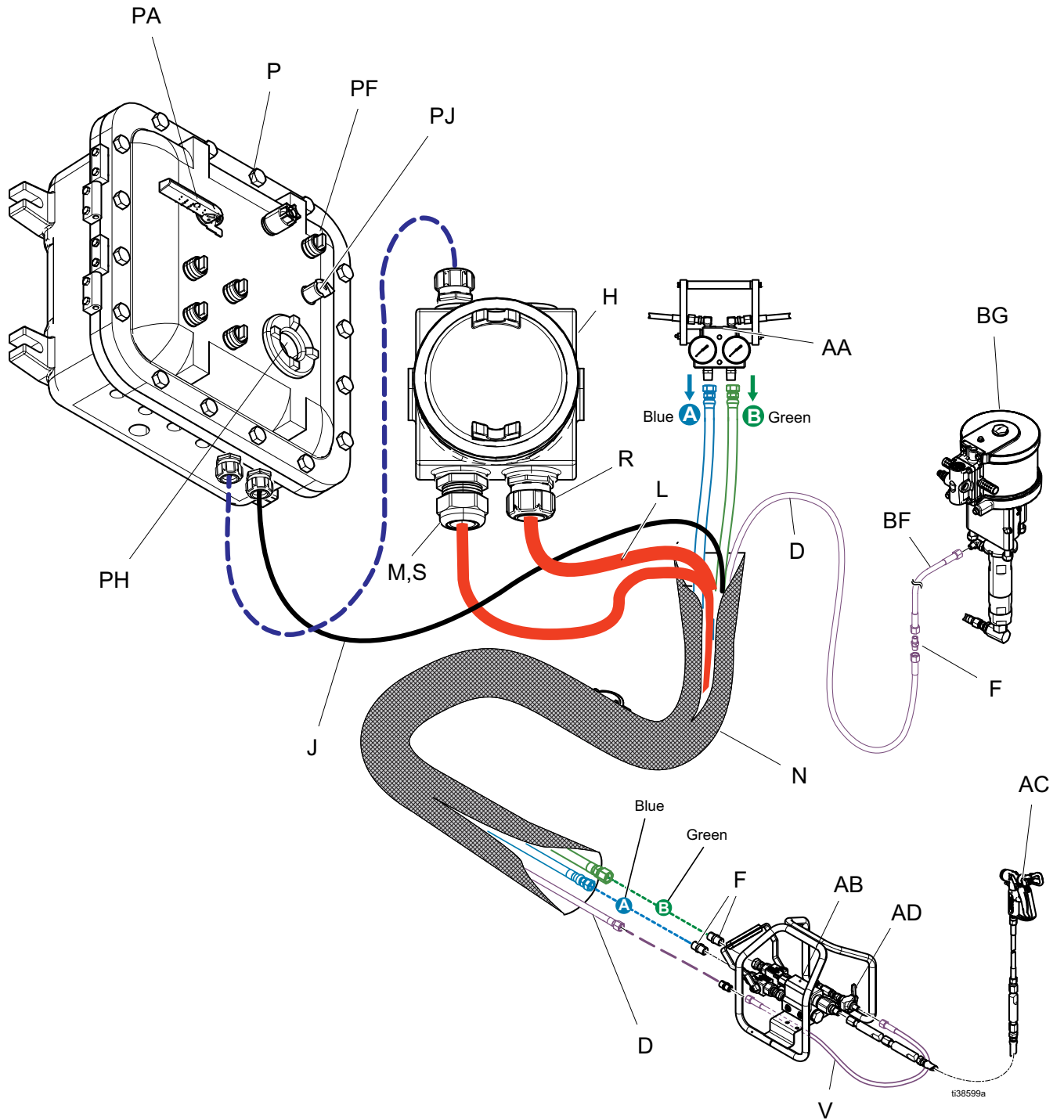

### Hazardous Location 50-150 ft Hoses

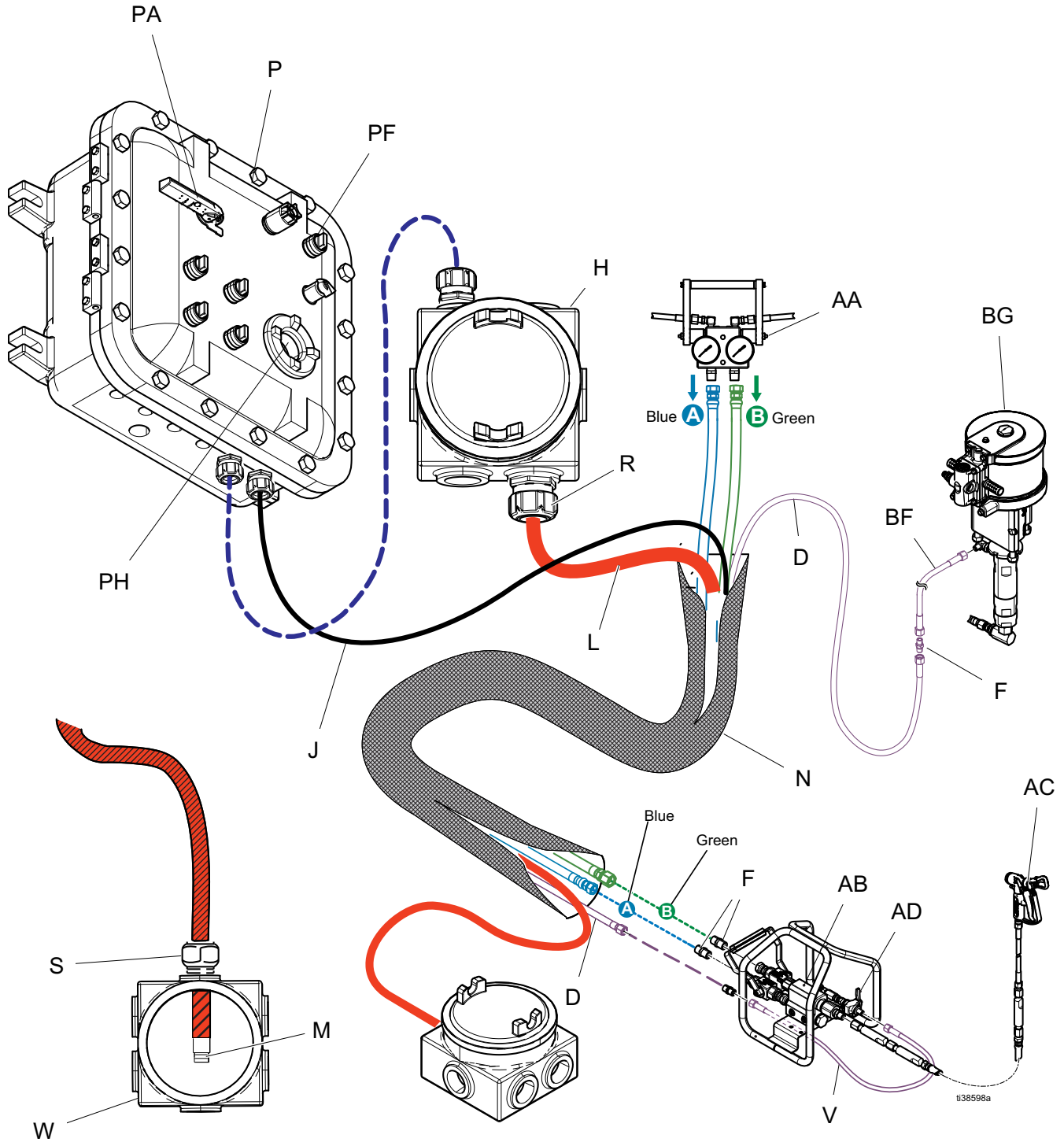

### Hazardous Location 200 ft Hoses



## Connect the Temperature Sensor

				
---	---	---	--	--

Improperly installed or connected equipment will create a hazardous condition and cause fire, explosion, or electric shock. Follow all local regulations.

Turn off and disconnect power at the main switch before disconnecting any cables and before servicing equipment. Ensure that the hose heat trace is cool before performing repair work or installation. All electrical work must be done by a qualified electrician and comply with local codes and regulations.

If your system is intended for hazardous locations, you must have a qualified electrician connect the heat cable wiring. Make sure the wiring and installation comply with all codes and regulations for hazardous locations.

1. Turn off power at the main source. Turn the main power switch (PA) to OFF.
  2. Open the Xtreme-Wrap (N). Locate the temperature sensor band (K).
- NOTE:** The temperature sensor band (K) is 36 in. (91.4 cm) from the proportioner end of the hose bundle.
3. Fully insert the temperature sensing probe (J) from the temperature controller into the temperature sensor band (K) as shown in FIG. 10.
  4. Create a strain relief loop (SR) with the temperature sensing probe wire (J) as shown in FIG. 10. Use tape or a strap to secure the strain relief loop into place.
  5. Secure Xtreme-Wrap (N).

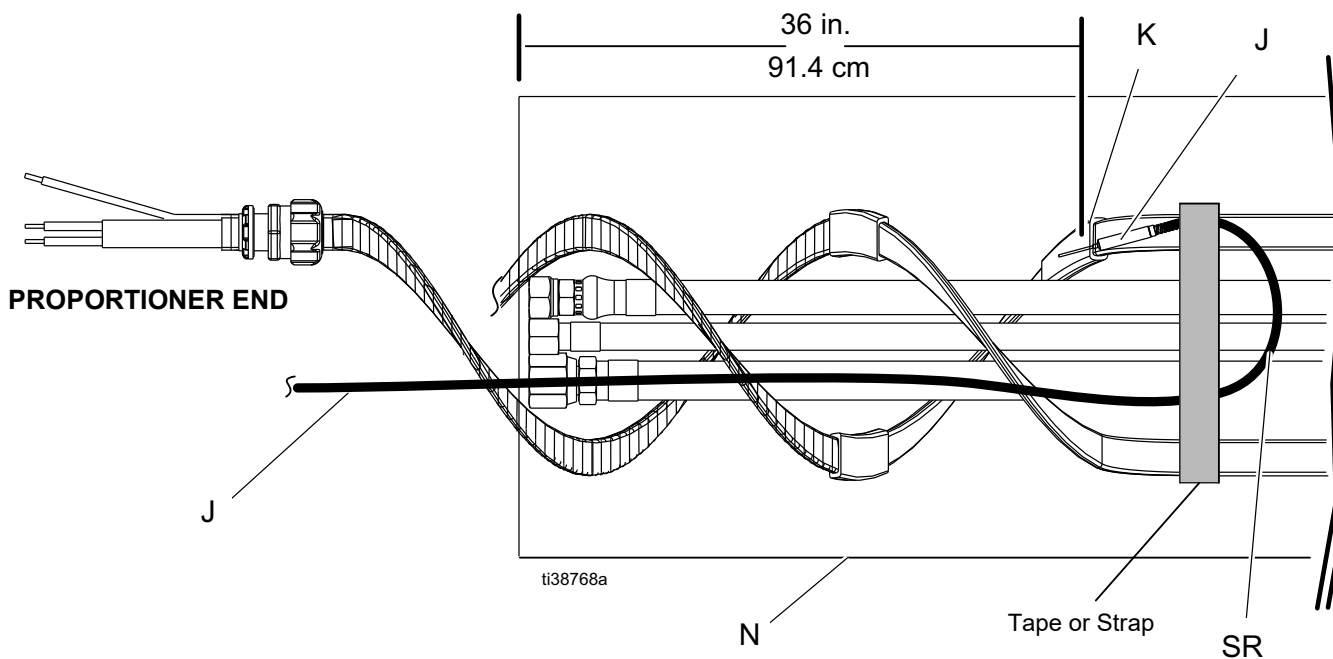

**FIG. 10: Temperature Sensor Installation**

# Operation



Do not operate a coiled hose. A coiled hose creates uneven heat build up, which can result in hose rupture and serious injury, such as skin injection and splashing fluid.

This equipment stays pressurized until pressure is manually relieved. To help prevent serious injury from pressurized fluid, such as skin injection and splashing fluid, follow the Pressure Relief Procedure when you stop spraying.

Bends, excess weight, and sharp edges can cause excessive strain to the hose. Excessive strain can result in equipment rupture and serious injury. Ensure that the hose is properly supported to avoid excessive strain.

Fluids subjected to heat in confined spaces, including hoses, can create a rapid rise in pressure due to thermal expansion. Over-pressurization can result in equipment rupture and serious injury. Replace hose proactively at regular intervals based on your operating conditions.

1. Turn the main power switch (PA) and hose heater switch (PF) to the ON position. The hose temperature controller display (TF) should be ON.
2. Press the enter button (TC) until set point 1 (SP1) appears in the display screen (TF).
3. Press or hold the arrow keys (TD, TE) to change the current set point temperature.
4. Press the enter button (TC) to save the set point value.

**NOTE:** The display (TF) will return to the actual temperature after five seconds.

5. Press the enter button (TC) again to display set point 2 (SP2).

**NOTE:** SP2 is a non-adjustable over-temperature set point.

6. After the hose reaches the desired temperature, increase to the desired spray pressure. See your proportioner manual.
7. Turn the main power switch (PA) to the OFF position when any of the following situations occur:
  - Breaks in spraying
  - Overnight shutdown
  - Before servicing













## Pressure Relief Procedure





This equipment stays pressurized until pressure is manually relieved. To help prevent serious injury from pressurized fluid, such as skin injection and splashing fluid, follow the Pressure Relief Procedure in your proportioner manual when you stop spraying and before cleaning, checking, or servicing the equipment.





Follow the **Pressure Relief Procedure** in your proportioner manual.

## Change Temperature Units (18C175 and Non-Hazardous Location Junction Box)







1. Enter the setup menu by pressing and holding  (scroll) and “SET” is shown on the display.
2. Press  (scroll) repeatedly until “LOCK” is shown on the display.
3. Press the  (up) or  (down) arrow until “NONE” is shown on the display.
4. Press  (scroll) again until “UNIT” is shown on the display.
5. Press the  (up) or  (down) arrow buttons until the desired unit of °C or °F is shown on the display.
6. Press  (scroll) to return to the setup menu. “UNIT” will be shown on the display again.
7. Press  (scroll) repeatedly until “LOCK” is shown on the display again.
8. Press the  (up) or  (down) arrow buttons until “USER” is shown on the display.
9. Press  (scroll) to return to the setup menu. “LOCK” will be shown on the display again.

Return to the actual temperature display and normal operation by pressing the  (up) and  (down) buttons at the same time, then release.

## Change Temperature Setpoint (18C175 and Non-Hazardous Location Junction Box)

1. Press and hold  (scroll) until “SP1” is shown on the display.
2. Press the  (up) or  (down) arrow until the desired temperature is shown on the display.
3. Press  (scroll) until the actual temperature is shown on the display.

## Change Temperature Units (Hazardous Location Junction Box)

1. Press the  (up) and  (down) arrows until the display shows “SET” in green text after approximately six seconds.
2. Press the  (up) arrow key twice to show “GLBL/SET” on the display.
3. Press the  (enter) key until the display shows “C\_F” in green text.
4. Press  (up) or  (down) arrow buttons until the display shows the desired temperature units.
5. Press the  (return) key until the actual temperature is displayed.

## Change Temperature Setpoint (Hazardous Location Junction Box)

Adjust the potentiometer knob (PJ) on the door while monitoring the display through window (PH).

**NOTE:** Turn the knob clockwise to increase the temperature setpoint, or counterclockwise to decrease the temperature setpoint.

# Troubleshooting

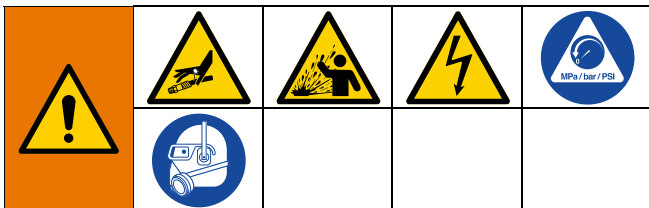

1. Follow the **Pressure Relief Procedure** in your proportioner manual.
2. Disconnect power.

Problem	Cause	Solution
Hose heats up slower than usual or does not reach set temperature	Fluid temperature is too cold	Ensure fluid temperature is within the equipment specifications. Ensure fluids are stored at chemical supplier specifications. Raise fluid temperatures as necessary.
	Temperature sensor failed or not installed correctly	Follow the <b>Hazardous Location 50-150 ft Hoses</b> procedure on page 27.
	Low supply voltage	Verify line voltage. Low line voltage significantly reduces power available to hose heat system.
Hose temperature exceeds set point	A and/or B heaters are overheating material	Check primary heaters for faulty temperature sensors or heating elements. See your heater and proportioner manuals for further troubleshooting steps.
	Missing/damaged insulation around temperature sensor causing the hose heat to be ON constantly	Measure the DC voltage of the temperature sensor. Make sure the hose bundle has adequate insulation evenly covering the entire length and connection joints.
	SSR1 output is shortened	Measure the voltage on terminals SSR1-3 to SSR1-4. Voltage is 0 Vac when OT1 on the temperature controller and the green LED on SSR1 are OFF.
Erratic hose temperature	Faulty temperature sensor connections	Verify that the temperature sensor wires are secure.
	Temperature sensor was not installed correctly	Follow the <b>Hazardous Location 50-150 ft Hoses</b> procedure on page 27.
	Missing/damaged insulation around temperature sensor, causing the hose heat to be ON constantly	Make sure the hose bundle has adequate insulation evenly covering the entire length and connection joints.



Problem	Cause	Solution
Hose temperature below set point or hose does not maintain temperature while spraying	A and B set points are too low	Increase the A and B primary heater set points. The hose is designed to maintain temperature.
	Fluid temperature is too cold	Ensure fluid temperature is within the equipment and chemical product specifications. Raise fluid temperatures as necessary.
	Low supply voltage	Verify line voltage. Low line voltage significantly reduces power available to hose heat system.
	Loose hose electrical connections	Verify all electrical wiring to the hose.
Hose does not heat	Faulty temperature sensor connections	Verify that the temperature sensor wires are secure.
	Temperature sensor not installed correctly	
	Loose hose electrical connections	Verify all electrical wiring to the hose.
	Hose zone not turned on	Increase hose set point if necessary.
	Failed SSRs	Measured voltage on terminals SSR1-3 to SSR1-4. Voltage is 200-240 Vac (480 Vac for 480 volt systems) when OT1 on temperature controller and green LED on SSR1 is ON.
	Opened connection or failed hose heating element	Check hose resistance. Compare to <b>Hose length vs. Heater Resistance</b> on page 34. Inspect the GFCI for tripping and reset as necessary.
GFCI trips immediately	Incorrect hose heat wiring	Verify all electrical wiring to the hose.
	Shorted connection or failed hose heating element	Check hose resistance. Compare to <b>Hose length vs. Heater Resistance</b> on page 34.
No temperature display	Loose power cable	Verify all electrical wiring to the display.
	Failed temperature control (PH)	Verify power is to the display. If there is power, the display should be ON.
	No electrical power (tripped electrical breaker)	Inspect the power supply for a tripped breaker and reset breaker as necessary.
Wrong temperature displayed	Incorrect temperature control (PH) programming	Check temperature control (PH) programming for correct units (°F/°C).
		Replace temperature control (PH).
	Faulty temperature sensor connections	Verify the temperature sensor wires are secure.
	Temperature sensor not installed correctly	Verify the temperature sensor wires are secure.

## Temperature Control Error Codes

Display Symbol	Error Description	Corrective Action
Er04	Illegal setup values	Do not modify temperature control parameters. Replace temperature control.
Er10	Communication error	Inspect temperature control wiring. See your Junction Box manual.
Er11	Communication error	Inspect temperature control wiring. See your Junction Box manual.
Er14	Communication error	Inspect temperature control wiring. See your Junction Box manual.
Er15	Communication error	Inspect temperature control wiring. See your Junction Box manual.
AtEr	Fail to perform auto-tuning function	Do not modify temperature control parameters. Replace temperature control.
EEPE	EEPROM write error	Replace temperature control.
CJEr	Cold junction compensation for temperature sensor malfunction	Replace temperature control.
SbEr	Input sensor failure	Inspect sensor and sensor cabling. Replace/repair as necessary.
AdEr	A to D converter malfunction	Replace temperature control.

Temperature sensor temperature vs. mVdc voltage reading	
Temperature sensor temperature	Voltage mVdc Blue +, Red -
75° F (24° C)	0.1
100° F (38° C)	0.6
150° F (67° C)	1.9

Hose length vs. Heater Resistance (Resistance varies greatly depending on temperature of the heater wire)	
Hose length feet (meters)	Heat trace resistance Ohms
50 (15.2)	53
100 (30.5)	35
150 (46)	20
200 (61)	30

# Repair

## Turn Off Power to the Equipment

1. Turn the disconnect switch to OFF.
2. Unplug power from the wall or lockout the disconnect.

## Disconnect the Heater Cable

1. Turn the main power switch (PA) to OFF.
2. Open the cover of the heat cable splice box (H).
3. Disconnect the heat cable power lead wires L1 and L2 from the splice connector (U).
4. Disconnect the ground wire (G) from terminal (T).
5. Loosen the heat cable strain relief (R) from the heat cable splice box (H) and remove the heat cable (L).

## Replace Hoses

1. Follow the pressure relief procedure in your proportioner manual.
2. Disconnect the fluid lines and cap the hoses.
3. Open the Xtreme-Wrap (N).

## Solvent and Recirculation Hoses

1. Remove all electrical tape from heated hose bundle to free the solvent or recirculation lines.
2. Replace damage hose.
3. Secure all hoses and heated hose bundle together with electrical tape.
4. Close the Xtreme-Wrap (N).

## A and B Fluid Hoses

1. Remove all electrical tape from heated hose bundle.
2. Set the solvent and recirculation lines to the side.
3. Connect the repair hose to the damaged hose.

4. Pull the repair hose through the heated hose bundle by pulling on the damaged hose. Feel the new hose into the heated hose bundle and help direct it through the coils of heater wire.
5. Secure all hoses and heated hose bundle together with electrical tape.
6. Close the Xtreme-Wrap (N).

## Heat Cable Installation

1. Follow the pressure relief procedure in your proportioner manual.
2. Disconnect the fluid lines and cap the hoses.
3. Open the Xtreme-Wrap (N).
4. Remove all electrical tape from heated hose bundle.
5. Set the solvent and recirculation lines to the side.
6. Remove the heat cable (L) from the fluid hose bundle and discard.
7. Starting at the proportioner end, leave 60 in. (152 cm) of heat cable from the end of the fluid hose connections.
8. Wrap the heat cable around the hose bundle.

**NOTE:** The heat cable needs to lay flat against the side of the hose bundle as it wraps around the hose bundle. No twists in the heat cable is permitted.

## Hose Length: 50 ft, 100 ft, 150 ft (15 m, 30 m, 45 m)

1. The heat cable completing a full twist around the hose bundle every 12 in. (30 cm). See FIG. 1 on page 10.
2. On the mix manifold end of the hose bundle, the heat cable needs to have the bend to return toward the machine end. The bend radius needs to be at a minimum of 1-1/8 in. (2.8 cm). The bend should be 24 in. (60 cm) from the hose ends.
3. When wrapping the heat cord back to the machine end, do not cross the heat cable on itself. Both ends of the heat cable should wrap the hose bundle in the same direction.
4. Space the heat cable between the other heat cable wraps. The final wrap of the heat cable is 6 in. from the next wrap.

**Hose Length: 200 ft (60 m)**

1. The heat cable completing a full twist around the hose bundle every 6 in. (15 cm). See FIG. 2 on page 11.
2. On the mix manifold end of the hose bundle, the heat cable should exit the hose bundle and extend past the hose ends by 60 in. (152 cm).
3. Secure every 2 to 3 ft (0.6 to 0.9 m) with electrical tape to hold the heat cable in place. Tighten the heat cable to the hose bundle as you apply the electrical tape.
4. Lay the hose bundle on the scruff guard along side the solvent hose and any recirculation hoses.
5. Secure all hoses and heated hose bundle together with electrical tape.
6. Close the Xtreme-Wrap (N).

# Repair Parts

## Part Number Example: HH7531X

HH	7	5	3	1	X
Heated Hose	7250 psi	'A' Hose Diameter: 5 = 1/2 in. 3 = 3/8 in. 2 = 1/4 in.	'B' Hose Diameter: 5 = 1/2 in. 3 = 3/8 in. 2 = 1/4 in.	Options: 1 = None 2 = Recirculation hoses added 3 = Second B hose 1/4 in. ID 4 = Recirculation and second B hoses added	Length: 5 = 50 ft X = 100 ft Y = 150 ft Z = 200 ft

### 50 ft (15.2 m) Hose Bundles

Hose Part Number	'A' Fluid	'B' Fluid	'B' Fluid	'A' Recirculation	'B' Recirculation	'Solvent'	Scuff Guard	Heat Trace	
HH73215	H73850	H72550	---	---	---	H42550	18B790	19D243	
HH73225			---	H73850	H73850		18B796		
HH73315		H73850	---	---	---		18B790		
HH73325			---	H73850	H73850		18B796		
HH75215	H75050	H72550	---	---	---		18B790		
HH75225			---	H73850	H73850		18B796		
HH75315		H73850	---	---	---		18B790		
HH75325			---	H73850	H73850		18B796		
HH75335			H72550	---	---		---		18B790
HH75345				---	H73850		H73850		18B796
HH75515		H75050	---	---	---		18B790		
HH75525			---	H73850	H73850		18B796		

### 100 ft (30.4 m) Hose Bundles

Hose Part Number	'A' Fluid	'B' Fluid	'B' Fluid	'A' Recirculation	'B' Recirculation	'Solvent'	Scuff Guard	Heat Trace	
HH7321X	H7381X	H7251X	---	---	---	H4251X	18B791	19D244	
HH7322X			---	H7381X	H7381X		18B797		
HH7331X		H7381X	---	---	---		18B791		
HH7332X			---	H7381X	H7381X		18B797		
HH7521X	H7501X	H7251X	---	---	---		18B791		
HH7522X			---	H7381X	H7381X		18B797		
HH7531X		H7381X	---	---	---		18B791		
HH7532X			---	H7381X	H7381X		18B797		
HH7533X			H7251X	---	---		---		18B791
HH7534X				---	H7381X		H7381X		18B797
HH7551X		H7501X	---	---	---		18B791		
HH7552X			---	H7381X	H7381X		18B797		

**150 ft (45.7 m) Hose Bundles**

Hose Part Number	'A' Fluid	'B' Fluid	'B' Fluid	'A' Recirculation	'B' Recirculation	'Solvent'	Scuff Guard	Heat Trace	
HH7321Y	H7381Y	H7251Y	---	---	---	H4251Y	18B792	19D245	
HH7322Y			---	H7381Y	H7381Y		18B798		
HH7331Y		H7381Y	---	---	---		18B792		
HH7332Y			---	H7381Y	H7381Y		18B798		
HH7521Y	H7501Y	H7251Y	---	---	---		18B792		
HH7522Y			---	H7381Y	H7381Y		18B798		
HH7531Y		H7381Y	---	---	---		18B791		
HH7532Y			---	H7381Y	H7381Y		18B798		
HH7533Y			H7251Y	---	---		---		18B792
HH7534Y				H7381Y	H7381Y		18B798		
HH7551Y		H7501Y	---	---	---		18B792		
HH7552Y			---	H7381Y	H7381Y		18B798		

**200 ft (60.9 m) Hose Bundles**

Hose Part Number	'A' Fluid	'B' Fluid	'B' Fluid	'A' Recirculation	'B' Recirculation	'Solvent'	Scuff Guard	Heat Trace	
HH7321Z	H7381Z	H7251Z	---	---	---	H4251Z	18B793	19D246	
HH7322Z			---	H7381Z	H7381Z		18B794		
HH7331Z		H7381Z	---	---	---		18B793		
HH7332Z			---	H7381Z	H7381Z		18B794		
HH7521Z	H7501Z	H7251Z	---	---	---		18B793		
HH7522Z			---	H7381Z	H7381Z		18B794		
HH7531Z		H7381Z	---	---	---		18B793		
HH7532Z			---	H7381Z	H7381Z		18B794		
HH7533Z			H7251Z	---	---		---		18B793
HH7534Z				H7381Z	H7381Z		18B794		
HH7551Z		H7501Z	---	---	---		18B793		
HH7552Z			---	H7381Z	H7381Z		18B794		

# Recycling and Disposal

## End of Product Life

At the end of a product's useful life, recycle it in a responsible manner.

## California Proposition 65

### CALIFORNIA RESIDENTS

 **WARNING:** Cancer and reproductive harm – [www.P65warnings.ca.gov](http://www.P65warnings.ca.gov).

## Technical Specifications

<b>Xtreme-Wrap Electric Heated Hose</b>		
	<b>US</b>	<b>Metric</b>
Maximum Fluid Operating Pressure	7250 psi	50 MPa, 500 bar
Maximum Fluid Operating Temperature	180 °F	82 °C
Maximum Temperature Set Point	150 °F	66 °C
Hose Operating Voltage	240 Vac	
Hose Operating Current	25 Amp	
Circuit Breaker Rating	25 Amp, 30 mAmp GFCI, Type D Curve	
Wetted Parts	Nylon, Zinc-Plated Carbon Steel, 303 Stainless Steel	
<b>Notes</b>		
All trademarks or registered trademarks are the property of their respective owners.		

# Graco Standard Warranty

Graco warrants all equipment referenced in this document which is manufactured by Graco and bearing its name to be free from defects in material and workmanship on the date of sale to the original purchaser for use. With the exception of any special, extended, or limited warranty published by Graco, Graco will, for a period of twelve months from the date of sale, repair or replace any part of the equipment determined by Graco to be defective. This warranty applies only when the equipment is installed, operated and maintained in accordance with Graco's written recommendations.

This warranty does not cover, and Graco shall not be liable for general wear and tear, or any malfunction, damage or wear caused by faulty installation, misapplication, abrasion, corrosion, inadequate or improper maintenance, negligence, accident, tampering, or substitution of non-Graco component parts. Nor shall Graco be liable for malfunction, damage or wear caused by the incompatibility of Graco equipment with structures, accessories, equipment or materials not supplied by Graco, or the improper design, manufacture, installation, operation or maintenance of structures, accessories, equipment or materials not supplied by Graco.

This warranty is conditioned upon the prepaid return of the equipment claimed to be defective to an authorized Graco distributor for verification of the claimed defect. If the claimed defect is verified, Graco will repair or replace free of charge any defective parts. The equipment will be returned to the original purchaser transportation prepaid. If inspection of the equipment does not disclose any defect in material or workmanship, repairs will be made at a reasonable charge, which charges may include the costs of parts, labor, and transportation.

**THIS WARRANTY IS EXCLUSIVE, AND IS IN LIEU OF ANY OTHER WARRANTIES, EXPRESS OR IMPLIED, INCLUDING BUT NOT LIMITED TO WARRANTY OF MERCHANTABILITY OR WARRANTY OF FITNESS FOR A PARTICULAR PURPOSE.**

Graco's sole obligation and buyer's sole remedy for any breach of warranty shall be as set forth above. The buyer agrees that no other remedy (including, but not limited to, incidental or consequential damages for lost profits, lost sales, injury to person or property, or any other incidental or consequential loss) shall be available. Any action for breach of warranty must be brought within two (2) years of the date of sale.

**GRACO MAKES NO WARRANTY, AND DISCLAIMS ALL IMPLIED WARRANTIES OF MERCHANTABILITY AND FITNESS FOR A PARTICULAR PURPOSE, IN CONNECTION WITH ACCESSORIES, EQUIPMENT, MATERIALS OR COMPONENTS SOLD BUT NOT MANUFACTURED BY GRACO.** These items sold, but not manufactured by Graco (such as electric motors, switches, hose, etc.), are subject to the warranty, if any, of their manufacturer. Graco will provide purchaser with reasonable assistance in making any claim for breach of these warranties.

In no event will Graco be liable for indirect, incidental, special or consequential damages resulting from Graco supplying equipment hereunder, or the furnishing, performance, or use of any products or other goods sold hereto, whether due to a breach of contract, breach of warranty, the negligence of Graco, or otherwise.

## **FOR GRACO CANADA CUSTOMERS**

The Parties acknowledge that they have required that the present document, as well as all documents, notices and legal proceedings entered into, given or instituted pursuant hereto or relating directly or indirectly hereto, be drawn up in English. Les parties reconnaissent avoir convenu que la rédaction du présente document sera en Anglais, ainsi que tous documents, avis et procédures judiciaires exécutés, donnés ou intentés, à la suite de ou en rapport, directement ou indirectement, avec les procédures concernées.

# Graco Information

For the latest information about Graco products, visit [www.graco.com](http://www.graco.com).

For patent information, see [www.graco.com/patents](http://www.graco.com/patents).

**TO PLACE AN ORDER**, contact your Graco distributor or call to identify the nearest distributor.

**Phone:** 612-623-6921 **or Toll Free:** 1-800-328-0211, **Fax:** 612-378-3505

*All written and visual data contained in this document reflects the latest product information available at the time of publication.  
Graco reserves the right to make changes at any time without notice.*

Original instructions. This manual contains English. MM 3A7524

**Graco Headquarters:** Minneapolis

**International Offices:** Belgium, China, Japan, Korea

**GRACO INC. AND SUBSIDIARIES • P.O. BOX 1441 • MINNEAPOLIS MN 55440-1441 • USA**  
**Copyright 2020, Graco Inc. All Graco manufacturing locations are registered to ISO 9001.**

[www.graco.com](http://www.graco.com)  
Revision E, May 2022