

## E60/E50 King TM Electric Driver

3A8119B  
EN

---

Electric driver for application of finishing materials and protective coatings using King Sprayers.  
For professional use only.



### Important Safety Instructions

Read all warnings and instructions in this manual and the system manual before using the equipment. Save all instructions.

*See pages 3 for model and approvals information.*

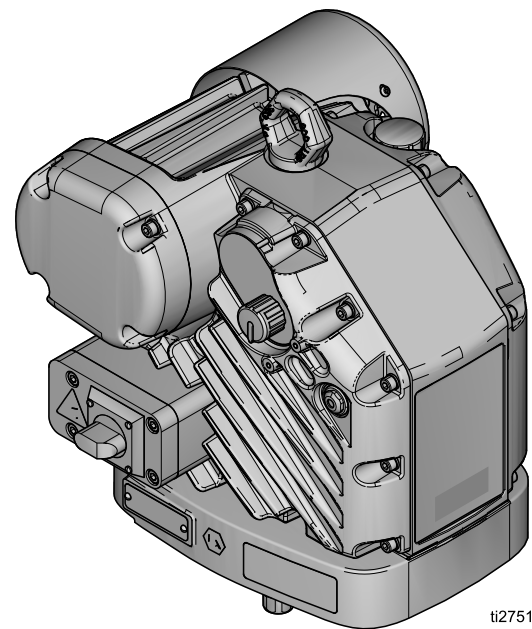

ti27514a

# Contents

Model Information.....	3	Power Requirements.....	8
Driver Model.....	3	Hazardous Area Cabling and Conduit Requirements.....	8
Related Manuals .....	3	Grounding .....	9
Warnings .....	4	Connect Power .....	10
Component Identification.....	7	General Repair Information .....	11
Installation.....	8	Graco Information.....	12

# Model Information

## Driver Model

Part	Series	Description	Weight
24X960	B	King Driver	110 lb (50 kg)



Ex db IIA T4 Gb -5°C ≤ Ta ≤ 50°C  
 FM15ATEX0060X; FM21UKEX0143X  
 IECEx FMG 15.0035X



APPROVED  
 Explosion proof. For Class 1, Div 1, Group D T4.  
 Zone 1, AEx db IIA T4 Gb -5°C ≤ Ta ≤ 50°C  
 Ex db IIA T4 Gb -5°C ≤ Ta ≤ 50°C  
 FM20CA0054X; FM20US0112X



### List of Standards







- IEC 60079-0
- IEC 60079-1
- EN 60079-0
- EN 60079-1
- ANSI/ISA 60079-0
- ANSI/UL 60079-1
- FM 3600
- FM 3615
- FM 3810
- CSA C22.2 No. 0.4
- CSA C22.2 No. 0.5
- CSA C22.2 No. 30
- CAN/CSA C22.2 60079-0
- CAN/CSA C22.2 60079-1
- CAN/CSA C22.2 No. 61010.1





## Related Manuals



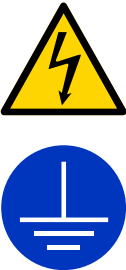

Manual in English	Description
3A8124	King E60/E50 Electric Driver Operation, Repair and Troubleshooting
3A8126	King E60/E50 Electric Sprayer
311619	Pump Mounting Kit Manual

# Warnings

The following warnings are for the setup, use, grounding, maintenance, and repair of this equipment. The exclamation point symbol alerts you to a general warning and the hazard symbols refer to procedure-specific risks. When these symbols appear in the body of this manual or on warning labels, refer back to these Warnings. Product-specific hazard symbols and warnings not covered in this section may appear throughout the body of this manual where applicable.

 <span style="font-size: 2em; font-weight: bold; letter-spacing: 0.5em;">WARNING</span>	
    	<p><b>FIRE AND EXPLOSION HAZARD</b></p> <p>Flammable fumes, such as solvent and paint fumes, in <b>work area</b> can ignite or explode. Paint or solvent flowing through the equipment can cause static sparking. To help prevent fire and explosion:</p> <ul style="list-style-type: none"> <li>• Use equipment only in well ventilated area.</li> <li>• Eliminate all ignition sources; such as pilot lights, cigarettes, portable electric lamps, and plastic drop cloths (potential static sparking).</li> <li>• Ground all equipment in the work area. See <b>Grounding</b> instructions.</li> <li>• Never spray or flush solvent at high pressure.</li> <li>• Keep work area free of debris, including solvent, rags and gasoline.</li> <li>• Do not plug or unplug power cords, or turn power or light switches on or off when flammable fumes are present.</li> <li>• Use only grounded hoses.</li> <li>• Hold gun firmly to side of grounded pail when triggering into pail. Do not use pail liners unless they are anti-static or conductive.</li> <li>• <b>Stop operation immediately</b> if static sparking occurs or you feel a shock. Do not use equipment until you identify and correct the problem.</li> <li>• Keep a working fire extinguisher in the work area.</li> </ul> <p>Static charge may build up on plastic parts during cleaning and could discharge and ignite flammable vapors. To help prevent fire and explosion:</p> <ul style="list-style-type: none"> <li>• Clean plastic parts only in well ventilated area.</li> <li>• Do not clean with a dry cloth.</li> <li>• Do not operate electrostatic guns in equipment work area.</li> </ul>
	<p><b>SPECIAL CONDITIONS FOR SAFE USE</b></p> <ul style="list-style-type: none"> <li>• To prevent the risk of electrostatic sparking, the equipment's non-metallic parts should be cleaned only with a damp cloth.</li> <li>• The aluminum housing may spark upon impact or contact with moving parts, which may cause fire or explosion. Take precautions to avoid such impact or contact.</li> <li>• All flameproof joints are critical to the integrity of the driver as approved for hazardous locations and are not repairable if damaged. Damaged parts must be replaced only with genuine Graco parts with no substitutions.</li> <li>• Consult Graco Technical Assistance or your Graco distributor if dimensional information on the flameproof joints is necessary.</li> <li>• Consult Graco Technical Assistance or your Graco distributor for genuine replacement fasteners. M8 x 30 socket-head cap screws of Class 12.9 steel or better with a minimum yield strength of 1100 MPa (160,000 psi) are acceptable alternatives. All socket-head cap screw cover fasteners must be torqued to 15 ft-lb (20.3 N•m).</li> </ul>

 <h1 style="margin: 0;">WARNING</h1>	
	<p><b>ELECTRIC SHOCK HAZARD</b> This equipment must be grounded. Improper grounding, setup, or usage of the system can cause electric shock.</p> <ul style="list-style-type: none"> <li>• Turn off and disconnect power at main switch before disconnecting any cables and before servicing or installing equipment.</li> <li>• Connect only to grounded power source.</li> <li>• All electrical wiring must be done by a qualified electrician and comply with all local codes and regulations.</li> <li>• Do not expose to rain. Store indoors.</li> <li>• Wait five minutes before servicing after power is removed.</li> </ul>
	<p><b>BURN HAZARD</b> Equipment surfaces and fluid that is heated can become very hot during operation. To avoid severe burns:</p> <ul style="list-style-type: none"> <li>• Do not touch hot fluid or equipment.</li> </ul>
	<p><b>MOVING PARTS HAZARD</b> Moving parts can pinch, cut or amputate fingers and other body parts.</p> <ul style="list-style-type: none"> <li>• Keep clear of moving parts.</li> <li>• Do not operate equipment with protective guards or covers removed.</li> <li>• Pressurized equipment can start without warning. Before checking, moving, or servicing equipment, follow the <b>Pressure Relief Procedure</b> and disconnect all power sources.</li> </ul>
	<p><b>SKIN INJECTION HAZARD</b> High-pressure fluid from gun, hose leaks, or ruptured components will pierce skin. This may look like just a cut, but it is a serious injury that can result in amputation. <b>Get immediate surgical treatment.</b></p> <ul style="list-style-type: none"> <li>• Do not spray without tip guard and trigger guard installed.</li> <li>• Engage trigger lock when not spraying.</li> <li>• Do not point gun at anyone or at any part of the body.</li> <li>• Do not put your hand over the spray tip.</li> <li>• Do not stop or deflect leaks with your hand, body, glove, or rag.</li> <li>• Follow the <b>Pressure Relief Procedure</b> when you stop spraying and before cleaning, checking, or servicing equipment.</li> <li>• Tighten all fluid connections before operating the equipment.</li> <li>• Check hoses and couplings daily. Replace worn or damaged parts immediately.</li> </ul>



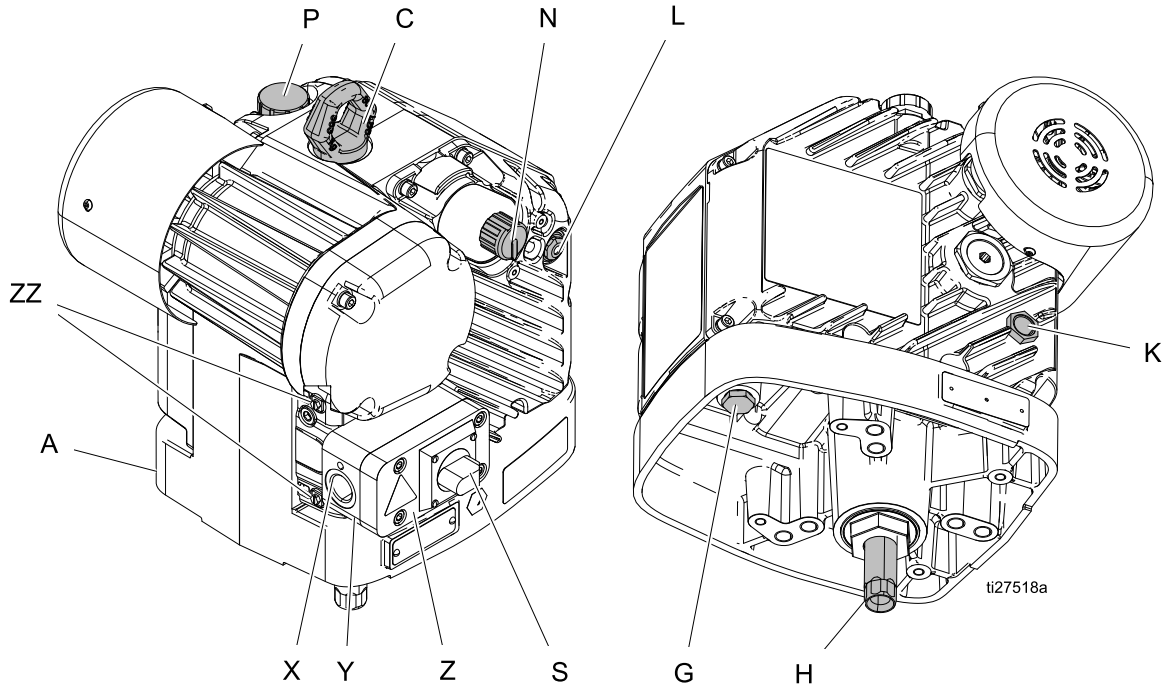

 <h1 style="margin: 0;">WARNING</h1>	
	<p><b>TOXIC FLUID OR FUMES</b> Toxic fluids or fumes can cause serious injury or death if splashed in the eyes or on skin, inhaled, or swallowed.</p> <ul style="list-style-type: none"> <li>• Read Safety Data Sheets (SDSs) to know the specific hazards of the fluids you are using.</li> <li>• Store hazardous fluid in approved containers, and dispose of it according to applicable guidelines.</li> </ul>
	<p><b>PERSONAL PROTECTIVE EQUIPMENT</b> Wear appropriate protective equipment when in the work area to help prevent serious injury, including eye injury, hearing loss, inhalation of toxic fumes, and burns. Protective equipment includes but is not limited to:</p> <ul style="list-style-type: none"> <li>• Protective eyewear, and hearing protection.</li> <li>• Respirators, protective clothing, and gloves as recommended by the fluid and solvent manufacturer.</li> </ul>
 	<p><b>EQUIPMENT MISUSE HAZARD</b> Misuse can cause death or serious injury.</p> <ul style="list-style-type: none"> <li>• Do not operate the unit when fatigued or under the influence of drugs or alcohol.</li> <li>• Do not exceed the maximum working pressure or temperature rating of the lowest rated system component. See <b>Technical Specifications</b> in all equipment manuals.</li> <li>• Use fluids and solvents that are compatible with equipment wetted parts. See <b>Technical Specifications</b> in all equipment manuals. Read fluid and solvent manufacturer's warnings. For complete information about your material, request Safety Data Sheets (SDSs) from distributor or retailer.</li> <li>• Do not leave the work area while equipment is energized or under pressure.</li> <li>• Turn off all equipment and follow the <b>Pressure Relief Procedure</b> when equipment is not in use.</li> <li>• Check equipment daily. Repair or replace worn or damaged parts immediately with genuine manufacturer's replacement parts only.</li> <li>• Do not alter or modify equipment. Alterations or modifications may void agency approvals and create safety hazards.</li> <li>• Make sure all equipment is rated and approved for the environment in which you are using it.</li> <li>• Use equipment only for its intended purpose. Call your distributor for information.</li> <li>• Route hoses and cables away from traffic areas, sharp edges, moving parts, and hot surfaces.</li> <li>• Do not kink or over bend hoses or use hoses to pull equipment.</li> <li>• Keep children and animals away from work area.</li> <li>• Comply with all applicable safety regulations.</li> </ul>

# Component Identification





Ref.	Description
A	Driver
C	Lift Ring
G	Oil Drain Plug
H	Driver Output Shaft
K	Oil Sight Glass
L	Status Indicator Light (LED)
N	Pressure Control Knob
P	Oil Fill Cap (vented)
S	Power Switch (Lock-out tag-out equipped)
Y	Electrical Junction Box
X	Conduit Entry
Z	Electrical Junction Box Cover
ZZ	Ground Screws

# Installation

				
<p>Installation of this equipment involves potentially hazardous procedures. Only trained and qualified personnel who have read and who understand the information in this manual should install this equipment.</p>				

**NOTE:** For complete Technical Specification information, see Driver Operation manual.

## Power Requirements

				
<p>Improper wiring may cause electric shock or other serious injury if work is not performed properly. Have a qualified electrician perform any electrical work. Be sure your installation complies with all Local codes and regulations.</p>				

See the table below for power supply requirements. The driver requires a dedicated circuit protected with a circuit breaker.

Model	Voltage	Phase	Hz	Amperage
24X960	200–240 Vac	1	50/60	15A
	100–120 Vac	1	50/60	25A

The protective earthing ground conductor must be equal to the phase conductors.

## Hazardous Area Cabling and Conduit Requirements

### Explosion Proof

All electrical wiring in the hazardous area must be encased in Class I, Division I, Group D approved explosion-proof conduit. Follow all National, State, and Local electric codes.

A conduit seal is required within 18 in. (457 mm) of the driver for the US and Canada. See [Connect Power, page 10](#).

All cables must be rated 70°C minimum.





### Flame Proof (ATEX)

Use appropriate conduit, connectors, and cable glands rated for ATEX II 2 G. Follow all Local codes and regulations.

All cable glands and cables must be rated 70°C minimum.



## Grounding

				
<p>This equipment must be grounded to reduce the risk of static sparking and electric shock. Electric or static sparking can cause fumes to ignite or explode. Improper grounding can cause electric shock. Grounding provides an escape wire for the electric current.</p>				

### Driver:

The driver is grounded through the power cord.

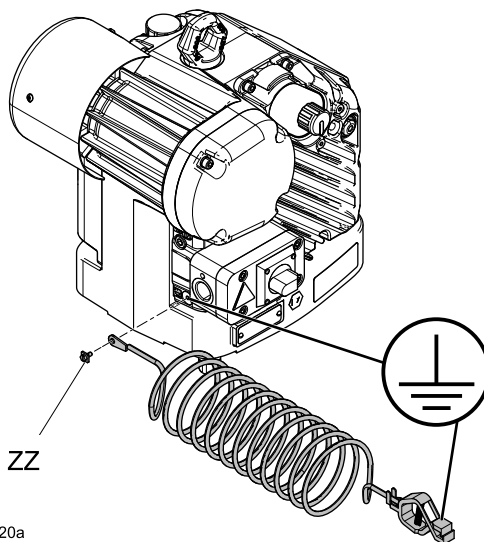

ti27520a

### Driver (optional secondary):

Pump Ground Wire – Two ground terminals are provided if local code requires redundant grounding connections.

Loosen the ground screw (ZZ) and attach a ground wire (Graco part 244524 – not supplied). Tighten the ground screw securely. Connect the other end of the ground wire to a true earth ground.

## Connect Power

<p>Improper wiring may cause electric shock, fire and explosion, or other serious injury if work is not performed properly. Have a qualified electrician perform any electrical work. Be sure your installation complies with all National, State and Local safety and fire codes.</p>				

1. Shut off the fused safety switch (B) and follow the appropriate lock-out/tag-out procedures. Typical fixed installation for wall mounted systems shown below:

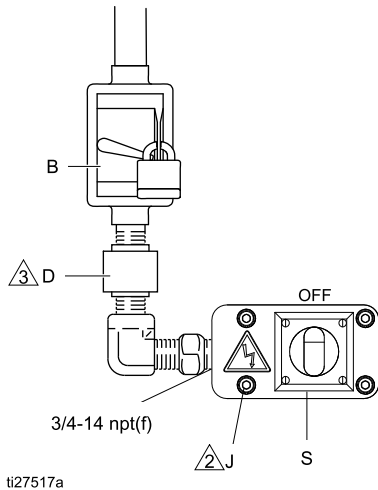

Disconnect Block Terminals	
1	Tighten disconnect block terminals to 7 in-lb (0.8 N•m). Do not over-tighten.
2	Tighten cover screws to 15 ft-lb (20.3 N•m).
3	A conduit seal (D) is required within 18 in. (457 mm) of the driver for the US and Canada.
4	15 in-lb maximum (terminal bushings)

2. To install wiring, locate the electrical junction box (Y). Remove four screws (J) and junction box cover (Z). Wires will already be installed in the front side of the disconnect in terminals labeled 1L1 and 3L2.
3. Connect the ground wire to the labeled ground screw in the back of the junction box. See [Grounding, page 9](#).

4. Install incoming power wires into the disconnect terminals labeled 2T1 and 4T2, and torque to 7 in-lb (0.8 N•m).
5. Reinstall junction box cover (Z) and screws (J). Torque screws to 15–20 ft-lb (21–27 N•m).

**NOTE:** One wire is installed in terminals 1L1 and 3L2.



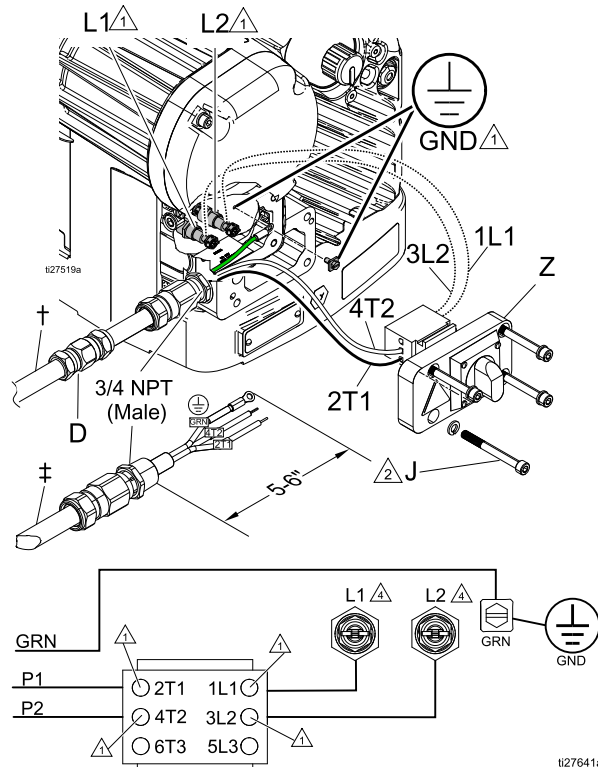



<p>Make sure wires are not pinched when re-installing covers. Wires will be damaged and create an electrical hazard and/or fire and explosion hazard if pinched.</p>				



- † Conduit not supplied.
- ‡ Power cord not supplied.

# General Repair Information

**NOTE:** See Driver Repair manual for specific instructions.

To avoid electric shock, fire and explosion hazard, and/or injury from moving parts hazard, turn off equipment power and shut off power at the main circuit breaker before repairing. Wear appropriate protective equipment when in work area. Wait five minutes before servicing.

Make sure wires are not pinched when re-installing covers. Wires will be damaged and create an electrical hazard and/or fire and explosion hazard if pinched.

**NOTE:** Consult Graco Technical Assistance or your Graco distributor for genuine replacement fasteners. M8 x 30 socket-head cap screws of Class 12.9 steel or better with a minimum yield strength of 1100 MPa (160,000 psi) are acceptable alternatives. All socket-head cap screw cover fasteners must be torqued to 15 ft-lb (20.3 N•m).

# Graco Information

**NOTE:** For Graco Warranty information see Driver Operation manual.

For the latest information about Graco products, visit [www.graco.com](http://www.graco.com). For patent information, see [www.graco.com/patents](http://www.graco.com/patents).

**To place an order,** contact your Graco Distributor or call to identify the nearest distributor. **Phone:** 612-623-6921 **or Toll Free:** 1-800-328-0211 **Fax:** 612-378-3505

All written and visual data contained in this document reflects the latest product information available at the time of publication. Graco reserves the right to make changes at any time without notice. Original Instructions. This manual contains English. MM **3A8119**

**Graco Headquarters:** Minneapolis **International Offices:** Belgium, China, Japan, Korea

**GRACO INC. AND SUBSIDIARIES • P.O. BOX 1441 • MINNEAPOLIS MN 55440-1441 • USA**

**Copyright 2021, Graco Inc. All Graco manufacturing locations are registered to ISO 9001.**

[www.graco.com](http://www.graco.com)

Revision B– September 2021