

- > Ø 8 ... 63 mm
- > Kleinere Bauart - nur ein Fünftel des vergleichbaren ISO-Zylinders
- > Dichtungen für geringe Reibung und lange Lebensdauer
- > Extrem festes, doppelt gecrimptes Enddeckel-design
- > Standardmagnetkolben für viele Einsatzgebiete

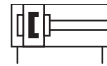

Technische Merkmale

Betriebsmedium:

Gefilterte, geölte oder ungeölte

Druckluft

Wirkungsweise:

Doppeltwirkend mit Endlagenpuffer

Betriebsdruck:

1 ... 10 bar (14 ... 145 psi)

Zylinderdurchmesser:

8, 10, 12, 16, 20, 25, 32, 40, 50, 63 mm

Hublängen:

Siehe Tabelle unten

Sonderhublängen:

<500 mm auf Anfrage

Gerätetemperatur:

+80°C max. (+176°F)

Um das Einfrieren der beweglichen Teile zu vermeiden, muss die Druckluft unter +2°C (+35°F) frei von Feuchtigkeit sein.

Material:

 Kolbenstange: Edelstahl rostfrei (Ø 8 bis 16 mm ferritisch, Ø 20 bis 63 mm austenitisch)
 Enddeckel: Aluminium
 Zylinderrohr: Edelstahl rostfrei (austenitisch)
 (Ø 8 ... 16 mm ferritisch, Ø 20 ... 63 mm austenitisch)
 Abstreifer: PUR
 Dichtungen und O-Ringe: NBR



Technische Daten

Zylinder Ø (mm)	8	10	12	16	20	25	32	40	50	63
Anschluss RT/572** (RM/572**)	M3 (M3)	M5 (M5)	M5 (M5)	M5 (M5)	Rc 1/8 (M6)	Rc 1/8 (M6)	Rc 1/8 (G 1/8)	Rc 1/8 (G 1/8)	Rc 1/4 (G 1/4)	Rc 1/4 (G 1/4)
Kolbenstangen Ø (mm)	3	4	4	6	8	10	12	14	16	20
Kolbenstangengewinde	M3	M4	M4	M6	M8	M10 x 1,25	M10 x 1,25	M12 x 1,25	M 12 x 1,25	M 16 x 1,5
Theoretische Kraft bei 6 bar ausfahrend (N)	30	46,8	67,8	120	188	294	482	754	1178	1870
Theoretische Kraft bei 6 bar einfahrend (N)	25,9	39,6	60	103	158	247	414	661	1057	1680
Luftverbrauch bei 6 bar ausfahrend (l/cm)	0,004	0,005	0,008	0,014	0,022	0,035	0,056	0,087	0,137	0,218
Luftverbrauch bei 6 bar einfahrend (l/cm)	0,003	0,004	0,006	0,013	0,019	0,02	0,048	0,074	0,114	0,195

Standardhublängen

Zylinder Ø (mm)	Hublänge (mm)										
	10	25	40	50	80	100	125	160	200	250	320
8	•	•	•	•	•	•	—	—	—	—	—
10	•	•	•	•	•	•	—	—	—	—	—
12	•	•	•	•	•	•	•	•	•	—	—
16	•	•	•	•	•	•	•	•	•	—	—
20	•	•	•	•	•	•	•	•	•	•	•
25	•	•	•	•	•	•	•	•	•	•	•
32	•	•	•	•	•	•	•	•	•	•	•
40	•	•	•	•	•	•	•	•	•	•	•
50	•	•	•	•	•	•	•	•	•	•	•
63	•	•	•	•	•	•	•	•	•	•	•

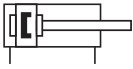
Alternative Ausführungen

Symbol	Typ mit Magnetkolben	Beschreibung	Abmessung Seite
	R./57200/M	Standardzylinder, Ø 8 bis 40 mm, Schwenkauge, Ø 50 und 63 mm	4 & 5
	R./57200/MC	Zylinder mit Zentralanschluss hinten	5
	R./57200/MF	Zylinder mit flachem Boden	5
	R./57200/JM	Durchgehende Kolbenstange, Ø 16 bis 63 mm	4





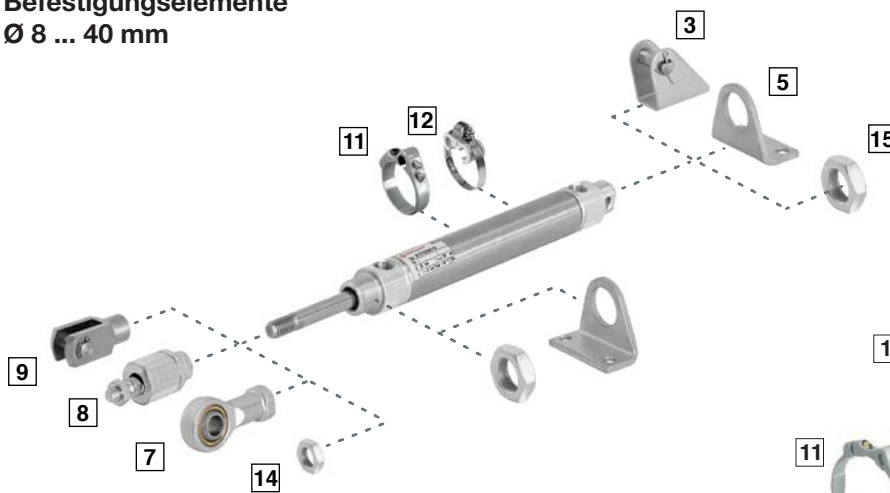
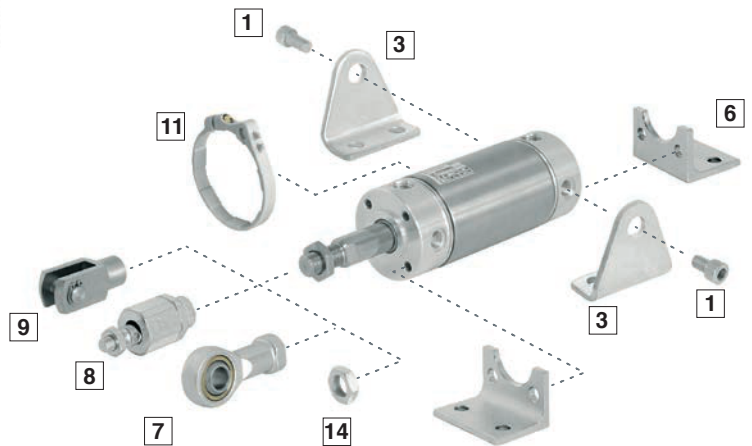

Typenschlüssel

Anschluss	Zylinder Ø (mm)	Kennung
M3	8	T
M5	10	T
M5	12	T
M5	16	T
M6	20	M
Rc1/8	20	T
M6	25	M
Rc1/8	25	T
G1/8	32	M
Rc1/8	32	T
G1/8	40	M
Rc1/8	40	T
G 1/4	50	M
Rc 1/4	50	T
G 1/4	63	M
Rc 1/4	63	T

R★/572★★/★★/★★★

Hub (mm)	Kennung
500 max.	
Ausführung	Kennung
Magnetkolben	M
Mit Magne kolben, flachem Boden, Zentralanschluss	MC
Mit Magne kolben, flachem Boden, seitl. Anschluss	MF
Mit Magne kolben, durchgehender Kolbenstange	JM
Zylinder Ø (mm)	Kennung
8	08
10	10
12	12
16	16
20	20
25	25
32	32
40	40
50	50
63	63

**Befestigungselemente
Ø 8 ... 40 mm**

Ø 50 und 63 mm

Zyl.	AK	C	F	H	L	N
						
	8	5	9	1	3	15
	Seite 6	Seite 6	Seite 6	Seite 6	Seite 6	Seite 7
8	—	M/P71273/1	QM/57008/25	—	QM/57008/24	M/P71364
10	QM/8010/38	M/P71273/2	QM/8010/25	—	QM/947	M/P71364
12	QM/8010/38	M/P71273/2	QM/8010/25	—	QM/947	M/P71364
16	QM/8012/38	M/P19369	QM/57016/25	—	QM/946	M/P1501/90
20	QM/8020/38	M/P19389	QM/57020/25	—	QM/8012/24	M/P13834
25	QM/8025/38	M/P40381	QM/57025/25	—	QM/57025/24	M/P13607
32	QM/8025/38	M/P19406	QM/57032/25	—	QM/8020/24	M/P13615
40	QM/8040/38	M/P71273/3	QM/57040/25	—	QM/57040/24	M/P29254
50	QM/8040/38	QM/57050/21	QM/57040/25	QM/55240/28	QM/57050/24	—
63	QM/8050/38	QM/57063/21	QM/57063/25	QM/55250/28	QM/57063/24	—

Zyl.	N2	UF	Befestigungselement für Schalter >15 mm Hub		Magnetschalter	
						
	14	7	11	12	Seite 8 & 9	
	Seite 7	Seite 7	Seite 7	Seite 7		
8	M/P1500/111	—	—	—		
10	M/P1501/80	QM/8010/32	QM/33/010/22	QM/33/010/23		
12	M/P1501/80	QM/8010/32	QM/33/012/22	QM/33/016/23		
16	M/P1501/79	QM/8012/32	QM/33/016/22	QM/33/016/23		
20	M/P1501/60	QM/8020/32	QM/33/020/22	QM/33/020/23		
25	M/P1501/89	QM/8025/32	QM/33/025/22	QM/33/025/23		
32	M/P1501/89	QM/8025/32	QM/33/032/22	—		
40	M/P1501/90	QM/8040/32	QM/33/040/22	—		
50	M/P1501/90	QM/8040/32	QM/33/050/22	—		
63	M/P1501/91	QM/8050/32	QM/33/063/22	—		

Abmessungen

Abmessungen in mm
Projection/First angle

Ø 8 ... 12 mm - RT/572../M

RT/572../MC

RT/572../MF

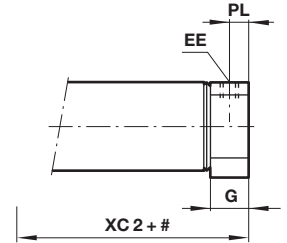
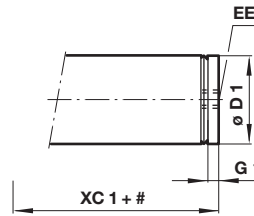
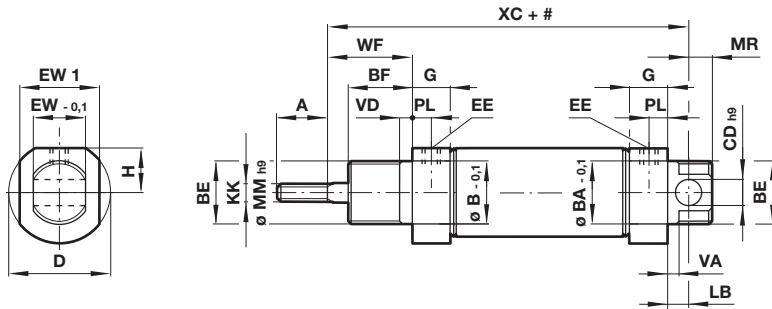

Ø 16 ... 40 mm - R./572../M

R./572../MC

RT/572../MF

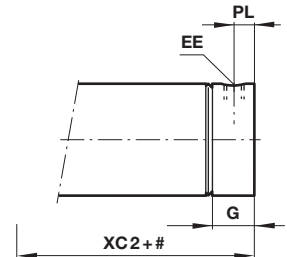
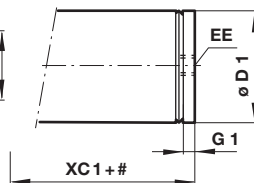
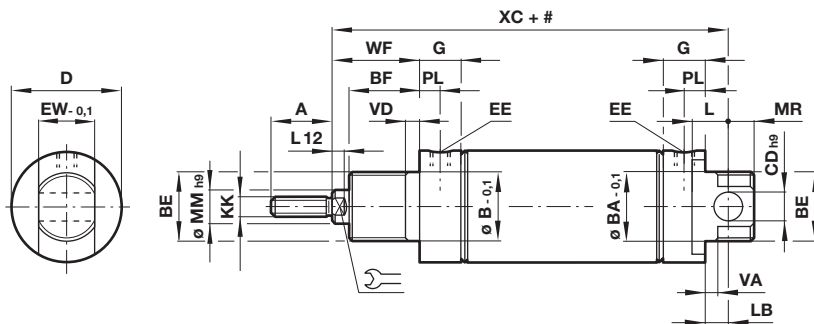

Hub

Ø	A	Ø B/Ø BA	BE	BF	Ø CD h9	Ø D	Ø D1	RT/5... EE	RM/5... EE	EW -0,1	EW1	G	G1	H	KK	L
8	8	10	M10 x 1	7,5	3	12	9,5	M3	M3	6	10	7,5	3	5	M3	-
10	9	10	M10 x 1	8	4	15	11,5	M5	M5	8	12,5	9,5	4,5	6,5	M4	-
12	9	10	M10 x 1	8	4	15	13	M5	M5	8	-	9,5	4,5	6,5	M4	-
16	12	12	M12 x 1,25	10	5	17,5	17,5	M5	M5	10	-	11,5	4	-	M6	-
20	14	16	M16 x 1,5	12	6	22	21,5	Rc 1/8	M6	12	-	15,5	8	-	M8	-
25	16	18	M18 x 1,5	12	8	26,5	26,5	Rc 1/8	M6	14	-	15,5	8	-	M10 x 1,25	-
32	22	22	M22 x 1,5	15	8	33,5	33,5	Rc 1/8	G 1/8	16	-	17,5	5,5	-	M10 x 1,25	12
40	23	30	M30 x 1,5	15	10	41,5	41,5	Rc 1/8	G 1/8	20	-	18	5,5	-	M12 x 1,25	14

Ø	LB	L12	Ø MM h9	MR	PL		VA/VD	WF	XC	XC1	XC2	kg bei 0 mm	kg per 25 mm	Typ
8	4,5	-	3	3	4	-	1,5	8,5	48	39	43,5	0,02	0,02	RT/57208/M*
10	5	-	4	4	5,5	-	1,5	10	54	44	49	0,02	0,03	RT/57210/M*
12	5	-	4	4	5,5	-	1,5	10	54	44	49	0,02	0,03	RT/57212/M*
16	7	5	6	5	5,5	5	2	13,5	64,5	50	57,5	0,04	0,05	RT/57216/M*
20	7	5	8	6	9	7	3	15,5	75,5	61	68,5	0,08	0,07	R./57220/M*
25	9	5	10	8	9	9	3	16,5	78,5	62	69,5	0,12	0,11	R./57225/M*
32	7	5	12	8	9	10	3	23	93	74	86	0,21	0,16	R./57232/M*
40	5	6	14	10	10	12	3	24	96	78,5	91	0,33	0,20	R./57240/M*

* Bitte Standardhublänge einfügen:

Ø 50 und 63 mm - R./57200/M

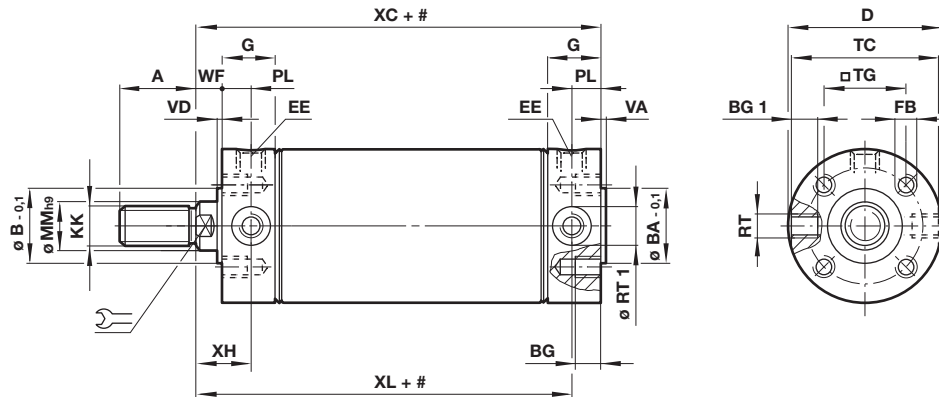
 Abmessungen in mm
Projection/First angle

Ø	A	Ø B/BA -0,1	BG	BG 1	Ø D	RT/57... EE	RM/57... EE	FB	G	KK	Ø MM h9	PL
50	23	28	12	8	52,5	Rc 1/4	G 1/4	M 6	22	M 12 x 1,25	16	13
63	30	35	12	9,5	65,5	Rc 1/4	G 1/4	M 8	22	M 16 x 1,5	20	13

Ø	RT	RT 1	SW	TG	TC	VA/VD	WF	XH	XL	kg bei 0 mm	kg per 100 mm	Typ
50	M 10 x 1	13	13	28,5	49	2	13	26	84	0,39	0,31	R./57250/M*
63	M 12 x 1,5	15	17	35,5	62	2	13	26	86	0,89	0,44	R./57263/M*

* Bitte Standardhublänge einfügen:

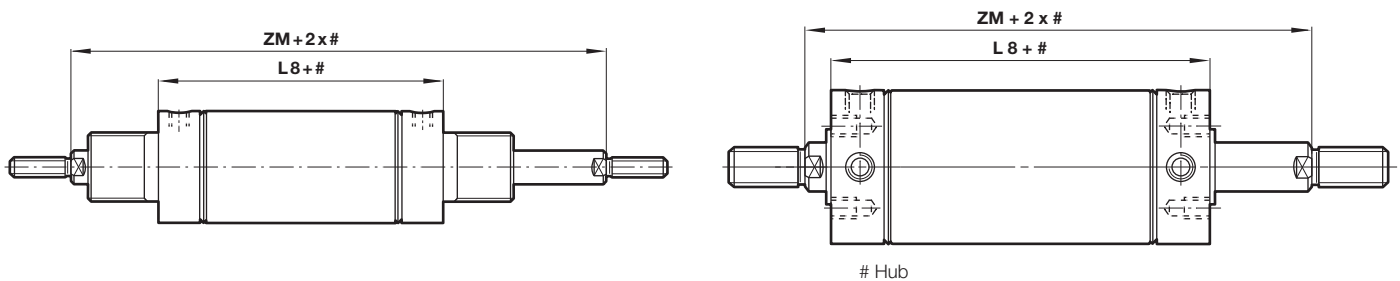
Ø 16 ... 63 mm - R./57200/JM

Ø	L8	ZM	Typ
16	44	71	R./57216/JM*
20	53	84	R./57220/JM*
25	53	86	R./57225/JM*
32	63	109	R./57232/JM*
40	67	115	R./57240/JM*
50	84	110	R./57250/JM*
63	86	112	R./57263/JM*

* Bitte Standardhublänge einfügen:

Befestigungselemente
Ausgleichkupplung AK
Entsprechend DIN ISO 8139

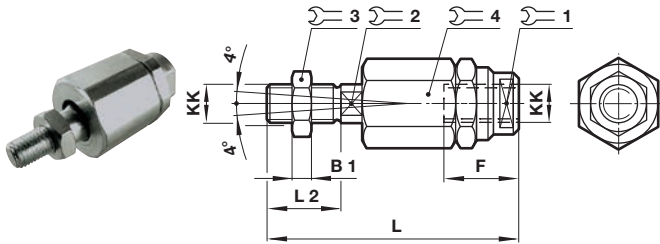

Ø	KK	B1	F	L	L2	1 2 3 4				kg	Typ (AK)
						1	2	3	4		
10/12	M 4	2	12,5	33	8	11	3,2	7	11	0,01	QM/8010/38
16	M 6	3	14	39	12	7	5	10	13	0,02	QM/8012/38
20	M 8	4	18	55	16	10	7	13	17	0,05	QM/8020/38
25/32	M 10x1,25	5	26	73	20	19	12	17	30	0,20	QM/8025/38
40/50	M 12x1,25	6	26	77	24	19	12	19	30	0,20	QM/8040/38
63	M 16x1,5	8	34	106	32	30	19	24	42	0,65	QM/8050/38

Fußbefestigung C
Entsprechend DIN ISO 6432

Abmessungen in mm
Projection/First angle

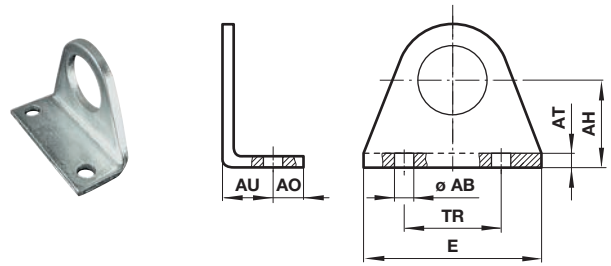

Ø	Ø AB	AH	AO	AT	AU	E	TR	kg	Typ (C)
8	3,8	10	3,5	1,5	7,5	25	18	0,01	M/P71273/1
10/12	5	12	4,5	1,5	7,5	30	20	0,01	M/P71273/2
16	4,5	16	6	2	10	35	25	0,02	M/P19369
20	5,5	20	6	3	13	43	32	0,03	M/P19389
25	6,6	22	8	3	12,5	49	38	0,04	M/P40381
32	6,6	25	7,5	4	16	53	40	0,06	M/P19406
40	7	28	7	4	16	66	52	0,08	M/P71273
50	9	40	10	4	17	52	36	0,18	QM/57050/21
63	9	47	10	5	19	61	45	0,28	QM/57063/21

Gabelkopf F
Entsprechend DIN ISO 8140

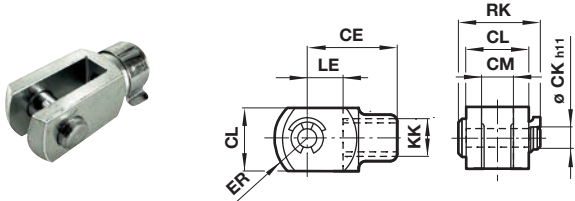

Ø	KK	CE	Ø CK h11	CL	CM	ER	LE	RK	kg	Typ (F)
8	M3	11	3	6	3	4,5	5	10,5	0,01	QM/57008/25
10/12	M4	16	4	8	4	6,5	8	11,5	0,01	QM/8010/25
16	M6	20	5	10	5	8	10	14,5	0,01	QM/57016/25
20	M8	24	6	12	6	9,5	12	17,5	0,02	QM/57020/25
25	M10x1,25	26	8	14	7	11,5	12	20,5	0,04	QM/57025/25
32	M10x1,25	32	8	16	8	13	16	22,5	0,05	QM/57032/25
40/50	M12x1,25	40	10	20	10	16	20	29	0,09	QM/57040/25
63	M 16x1,5	56	14	27	14	21	28	36,5	0,20	QM/57063/25

Schwenkbefestigung hinten L
for Ø 8 ... 40 mm

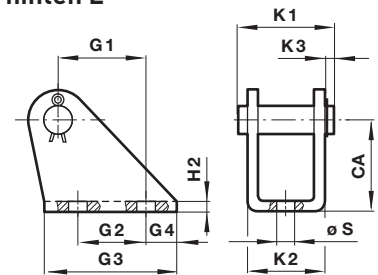

Ø 50 ... 63 mm

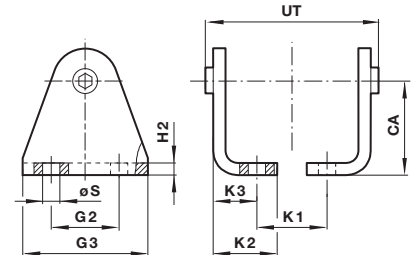

Ø	CA	G				H2	K			Ø S	UT	kg	Typ (L)
		1	2	3	4		1	2	3				
8	10	9	7	14	3,5	1	-	8	-	3,5	-	0,01	QM/57008/24
10/12	12	6,5	-	15	6	1	13,5	10,5	2	4,8	-	0,01	QM/947
16	16	13	10	22	6	1,5	-	12,5	-	4,8	-	0,02	QM/946
20	20	18,5	15	30	8	1,5	20	15	3	5,5	-	0,02	QM/8012/24
25	22	20	15	33	9	2	-	18	-	6,6	-	0,04	QM/57025/24
32	25	20	15	35	10	2	25	20,5	3	6,6	-	0,04	QM/8020/24
40	28	25	20	42	11	3	-	26	-	7	-	0,09	QM/57040/24
50	40	-	30	54	-	4	30,5	24	15	9	68	0,20	QM/57050/24
63	47	-	40	64	-	5	40,5	26,5	17,5	9	84	0,32	QM/57063/24

Schwenkzapfenbefestigung H

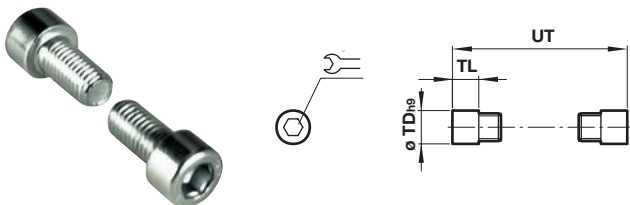

Ø	Ø TD h9	TL	UT	kg	Typ (H)
50	12	9,5	63	0,03	QM/55240/28
63	14	11	76	0,05	QM/55250/28

Mutter auf dem Kolbenstangenlager N

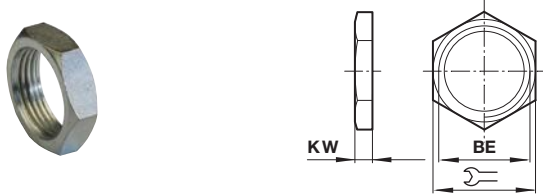

Ø	BE		KW	kg	Typ (N)
8...12	M10x1	14	4	0,01	M/P71364
16	M12x1,25	19	6	0,01	M/P1501/90
20	M16x1,5	22	5	0,01	M/P13834
25	M18x1,5	24	5	0,01	M/P13607
32	M22x1,5	27	8	0,02	M/P13615
40	M30x1,5	36	8	0,03	M/P29254

Mutter auf der Kolbenstange N2

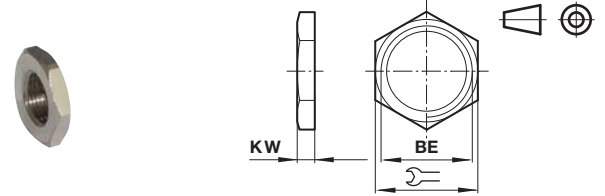

Ø	BE		KW	kg	Typ (N)
8	M3	6	2	0,01	M/P1500/111
10/12	M4	7	2	0,01	M/P1501/80
16	M6	10	3	0,01	M/P1501/79
20	M8	13	4	0,01	M/P1501/60
25/32	M10x1,25	17	5	0,01	M/P1501/89
40/50	M12x1,25	19	6	0,01	M/P1501/90
63	M16x1,5	24	8	0,02	M/P1501/91

Gelenkkopf UF Entsprechend DIN ISO 8139

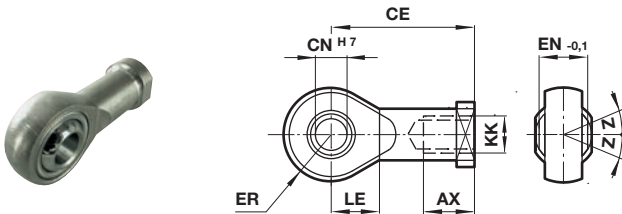

Ø	KK	AX	CE	Ø CN H7	EN -0,1	ER	LE	Z	kg	Typ (UF)
10/12	M4	14	27	5	8	8	10	5°	0,02	QM/8010/32
16	M6	14	30	6	9	9	11	5°	0,02	QM/8012/32
20	M8	16	36	8	12	11	13	5°	0,05	QM/8020/32
25/32	M10x1,25	25	42	10	14	14	15	13°	0,08	QM/8025/32
40/50	M12x1,25	22	50	12	16	16	17	13°	0,12	QM/8040/32
63	M16x1,5	28	64	16	21	21	22	15°	0,33	QM/8050/32

Befestigungselement für Schalter- Befestigungselement für > 15 mm Hub

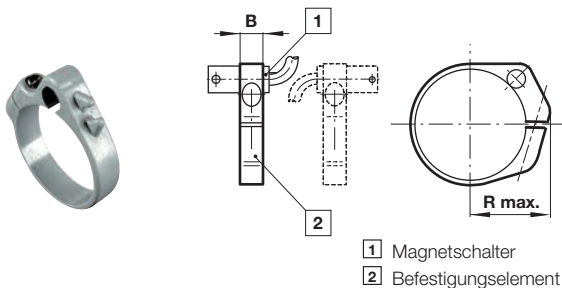

- 1 Magnetschalter
- 2 Befestigungselement

Ø	B	R max.	kg	Typ
10	8	16	0,01	QM/33/010/22
12	8	18	0,01	QM/33/012/22
16	10	20	0,01	QM/33/016/22
20	10	22	0,01	QM/33/020/22
25	10	24	0,01	QM/33/025/22
32	10	29	0,01	QM/33/032/22
40	10	32	0,01	QM/33/040/22
50	10	38	0,01	QM/33/050/22
63	10	46	0,01	QM/33/063/22

Befestigungselement für Schalter- Befestigungselement für < 15 mm Hub

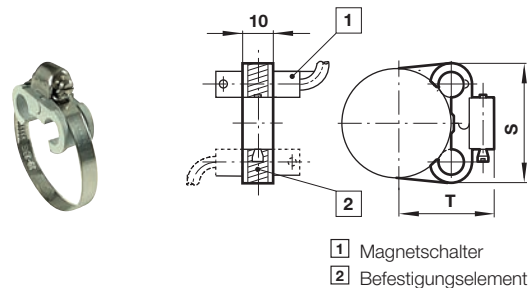

- 1 Magnetschalter
- 2 Befestigungselement

Ø	S	T	kg	Typ
10	27,5	19,5	0,01	QM/33/010/23
12	28,5	21,5	0,01	QM/33/016/23
16	29,5	23,5	0,01	QM/33/016/23
20	29,5	26	0,01	QM/33/020/23
25	31,5	28,5	0,01	QM/33/025/23

Technische Daten - Reed-Magnetschalter - weitere Information siehe Datenblatt N/de 4.3.005

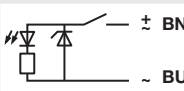
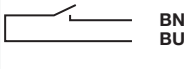
Symbol	Spannung		Schaltstrom max. (mA)	Funktion	Temperatur (°C)	LED	Schutzart	Stecker	Kabel- länge (m)	Anschluss- kabel	Gewicht (g)	Typ
	(V AC)	(V DC)										
	10 ... 240	10 ... 170	180	Schließer	-25 ... +80	•	IP66	—	2, 5 or 10	PVC 2 x 0,25	37	M/50/LSU/*V
	10 ... 240	10 ... 170										
	10 ... 240	10 ... 170	180	Schließer	-25 ... +150	—	IP66	—	2	Silicon 2 x 0,25	37	TM/50/RAU/2S
	10 ... 240	10 ... 170										
	10 ... 240	10 ... 170	180	Wechsler	-25 ... +80	—	IP66	—	5	PVC 3 x 0,25	37	M/50/RAC/5V
	10 ... 240	10 ... 170										
	10 ... 60	10 ... 60	180	Schließer	-25 ... +80	•	IP66	M8 x 1	0,3	PVC 3 x 0,25	16	M/50/LSU/CP *1)

* Bitte Kabellänge einfügen; *1) Kabel mit Steckdose; Farbkennzeichnung: BK = schwarz, BN = braun, BU = blau

Abmessungen

M/50/LSU/*V, M/50/LSU/5U,
TM/50/RAU/2S
Kabellänge L = 2, 5 oder 10 m

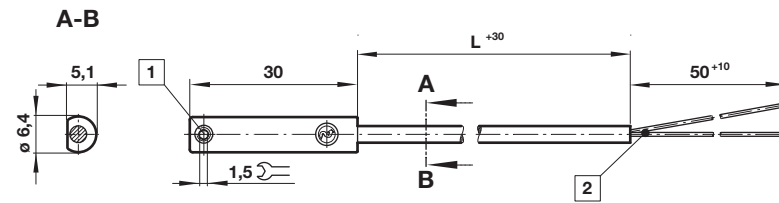

Abmessungen in mm
Projection/First angle



M/50/RAC/5V
Kabellänge L = 5 m

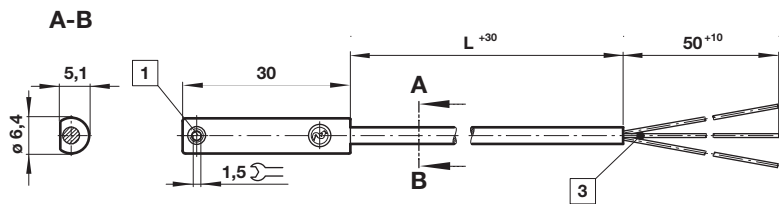

M/50/LSU/CP

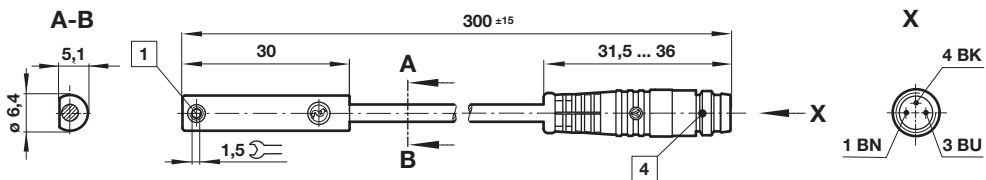

- 1 Feststellschraube
- 2 + BN = braun; - BU = blau (Ausgang)
- 3 - BK = schwarz; + BN = braun; - ≠BU = blau
- 4 Stecker M8 x 1, Farbkennzeichnung: BK = schwarz; BN = braun; BU = blau

Zubehör

Steckdose mit Kabel



Kabel	Kabellänge (m)	Gewicht (kg)	Stecker	Typ
PVC 3 x 0,25	5 m	0,18	M8 x 1	M/P73001/5
PUR 3 x 0,25	5 m	0,18	M8 x 1	M/P73002/5
PUR 3 x 0,34	5 m	0,21	M12 x 1	M/P34594/5

Technische Daten - elektronischer Magnetschalter - weitere Information siehe Datenblatt N/de 4.3.007

Symbol	Spannung (V DC)	Schaltstrom max. (mA)	Funktion	Temperatur (°C)	LED	Schutzart	Stecker	Kabel-länge (m)	An-schluss-kabel	Ge-wicht (g)	Typ
	10 ... 30	150	PNP	-40 ... +80	•	IP67	—	2, 5 or 10	PVC 3 x 0,12	37	M/50/EAP/*V
	10 ... 30	150	PNP	-40 ... +80	•	IP68	—	5	PUR 3 x 0,14	37	M/50/EAP/5U
	10 ... 30	150	PNP	-40 ... +80	•	IP67	M8 x 1	0,3	PVC 3 x 0,14	16	M/50/EAP/CP *1)
	10 ... 30	150	PNP	-40 ... +80	•	IP67	M12 x 1	0,3	PVC 3 x 0,14	16	M/50/EAP/CC *1)
	10 ... 30	150	NPN	-40 ... +80	•	IP67	—	2, 5 or 10	PVC 3 x 0,12	37	M/50/EAN/*V
	10 ... 30	150	Schließer	-40 ... +80	•	IP67	M8 x 1	0,3	PVC 3 x 0,14	16	M/50/EAN/CP *1)

* Bitte Kabellänge einfügen; *1) Kabel mit Steckdose; Farbkennzeichnung: BK = schwarz, BN = braun, BU = blau

Abmessungen

M/50/EAP/*V,
M/50/EAN/*V
Kabellänge L = 2, 5 oder 10 m

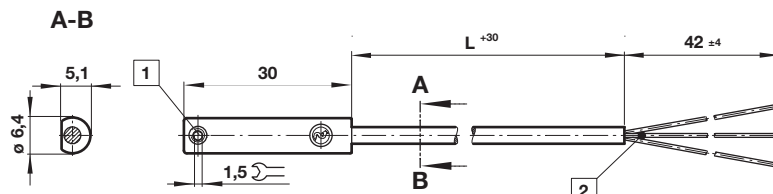

Abmessungen in mm
Projection/First angle



M/50/EAP/CP,
M/50/EAN/CP

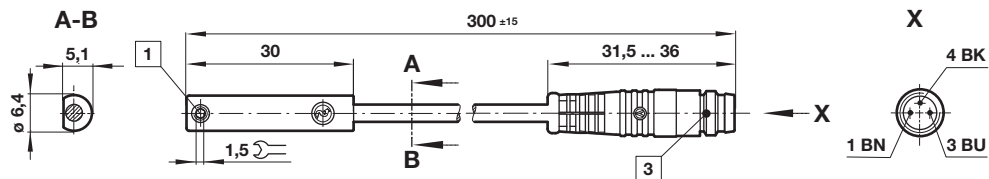

M/50/EAP/CC

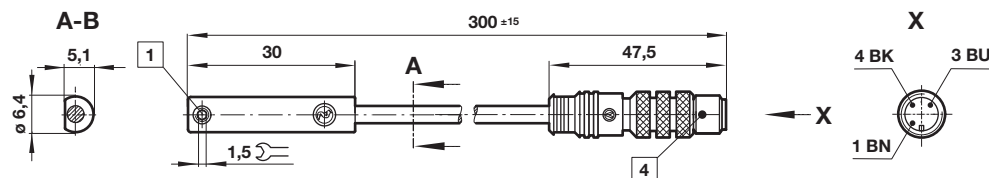

- 1 Feststellschraube
- 2 Farbkennzeichnung: BK = schwarz; BN = braun; BU = blau
- 3 Stecker M8 x 1
- 4 Stecker M12 x 1

Sicherheitshinweise

Diese Produkte sind ausschließlich in Druckluftsystemen zu verwenden. Sie sind dort einzusetzen, wo die unter »Technische Merkmale/-Daten« aufgeführten Werte nicht überschritten werden. Berücksichtigen Sie bitte die entsprechende Katalogseite. Vor dem Einsatz der Produkte bei nicht industriellen Anwendungen, in lebenserhaltenden- oder anderen Systemen, die nicht in den veröffentlichten Anleitungsunterlagen enthalten sind, wenden Sie sich bitte direkt an IMI NORGREN. Durch Missbrauch, Verschleiß oder Störungen können in Pneumatik-

systemen verwendete Komponenten auf verschiedene Arten versagen. Systemauslegern wird dringend empfohlen, die Störungsarten aller in Pneumatiksystemen verwendeten Komponententeile zu berücksichtigen und ausreichende Sicherheitsvorkehrungen zu treffen, um Verletzungen von Personen sowie Beschädigungen der Geräte im Falle einer solchen Störung zu verhindern. Systemausleger sind verpflichtet, Sicherheitshinweise für den Endbenutzer im Betriebshandbuch zu vermerken, wenn der Störungs-schutz nicht ausreichend gewährleistet ist.