

High Pressure Coolant Valve

Series SGH

3 MPa/7 MPa

Corresponding to high speed grinding and long drilling processes



Coolant valve for high pressure coolant liquid (up to 3 MPa/7 MPa) that is ideal for lubrication, dust blowing and cooling.

Service life: **3 million cycles**

(Based on SMC's test condition)

Power consumption: **0.35 W**

(24 VDC)

(With light/surge voltage suppressor: 0.58 W)

Water hammer: **Reduced by 20%**

(2-port)

(Compared to existing model, VNH series)

3-port dual pressure type is standardized.

(See applications 1 and 2.)

Flow-rate characteristics (2-port)

Pressure	Av x 10 ⁻⁶ [m ²]
7 MPa	42 (1.8) to 155 (6.5)

() : Cv factor



Application example

Example 1

3-port dual pressure, N.C. type

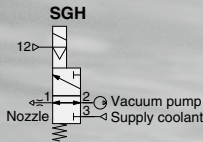

Fluid leakage can be avoided.

Example 2

3-port dual pressure, Selector type

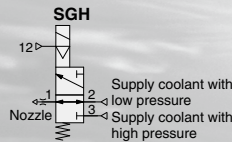

Coolant can be supplied at different pressures.

Example 3

2-port, Nozzle ON/OFF

SGH

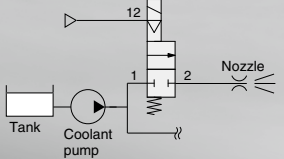

Example 4

3-port, Reducing load to pump

SGH

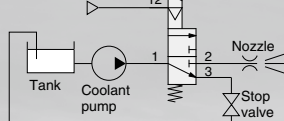

For reducing load to pump, coolant liquid is returned from B port to tank each time.

Example 5

3-port, Switching nozzles

SGH

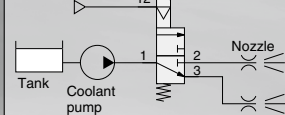

Switching nozzles on supplying coolant liquid. Possible to use as a 2-port valve by plugging the 3(B) port.

VNA

VNB

SGC

SGH

VNC

VNH

VND

VCC

TQ

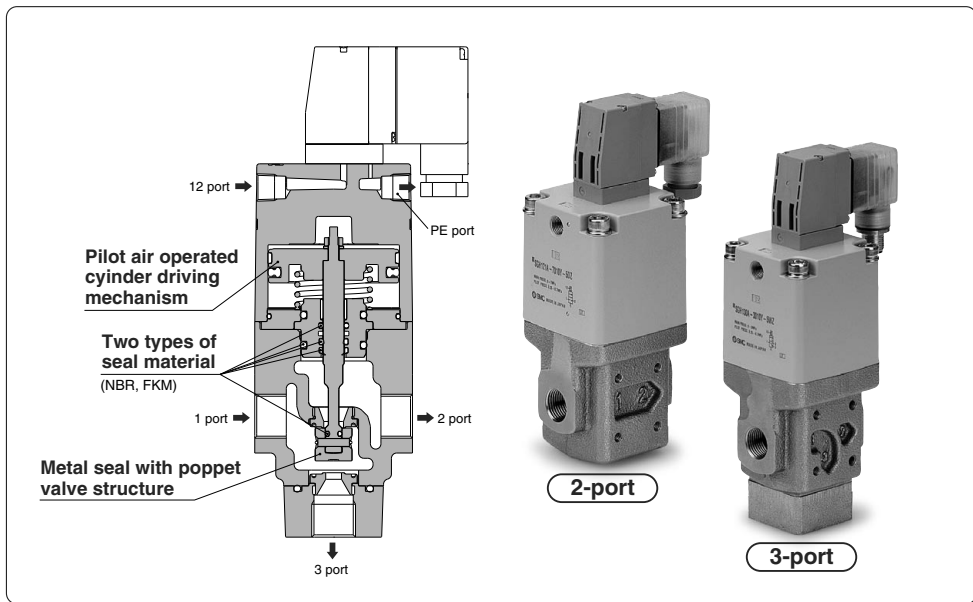

Variations

Port	Pressure specifications	Model	Port size	Orifice diameter ϕ [mm]		Flow-rate characteristics $Av \times 10^{-6}$ [m ²] () : Cv		Rated voltage
				1→2	1→3	1→2	1→3	
2-port	7 MPa	SGH(A)12□□-70□10	3/8	$\phi 7.5$	—	42 (1.8)	—	100 VAC 50/60 Hz 200 VAC 50/60 Hz 110 VAC [115 VAC] 50/60 Hz 220 VAC [230 VAC] 50/60 Hz 24 VDC 12 VDC
		SGH(A)22□□-70□15	1/2	$\phi 9.4$	—	65 (2.7)	—	
		SGH(A)32□□-70□20	3/4	$\phi 12.4$	—	112 (4.7)	—	
		SGH(A)42□□-70□25	1	$\phi 15.4$	—	155 (6.5)	—	
3-port	3 MPa	SGH(A)13□□-30□10	3/8	$\phi 11$	$\phi 9.4$	50 (2.1)	56 (2.3)	
		SGH(A)23□□-30□15	1/2		$\phi 10.5$	55 (2.3)	73 (3.0)	
		SGH(A)33□□-30□20	3/4	$\phi 15$	$\phi 12$	90 (3.8)	92 (3.8)	
		SGH(A)43□□-30□25	1	$\phi 17$	$\phi 15.2$	135 (5.6)	140 (5.8)	
3-port	7 MPa	SGH(A)13□□-70□10	3/8	$\phi 7.5$	$\phi 6$	26 (1.1)	23 (1.0)	
		SGH(A)23□□-70□15	1/2	$\phi 10.1$	$\phi 7.6$	45 (1.9)	49 (2.0)	
		SGH(A)33□□-70□20	3/4	$\phi 12.8$	$\phi 10$	78 (3.3)	65 (2.7)	
		SGH(A)43□□-70□25	1	$\phi 15.4$	$\phi 11.5$	102 (4.3)	84 (3.5)	

Electrical entry

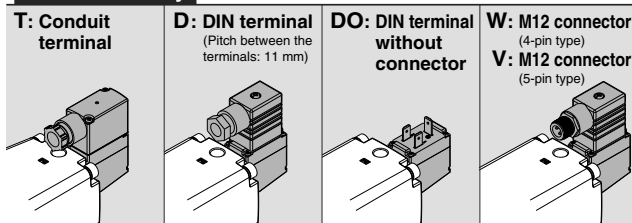

Bracket

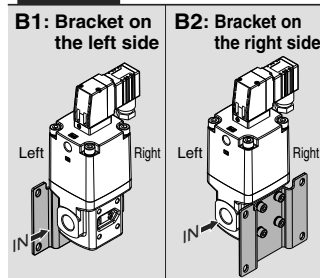

Coolant Valve

Series *SGH*



External pilot solenoid



Air operated

How to Order 2-Port Type

Note) Filter is installed on PE port as standard.

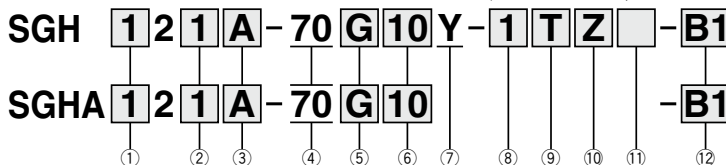

① Series	② Valve type	③ Seal material	④ Pressure range	⑤ Thread type	⑥ Port size
1 SGH100 2 SGH200 3 SGH300 4 SGH400	1 N.C. 2 N.O.	A NBR B FKM	70 Pressure range 0 to 7 MPa	Nil Rc G G (ISO1179-1) N NPT T NPTF	10 3/8 SGH100 15 1/2 SGH200 20 3/4 SGH300 25 1 SGH400

⑦ Pilot valve

Y V116

⑧ Rated voltage

1	100 VAC 50/60 Hz
2	200 VAC 50/60 Hz
3	110 VAC [115 VAC] 50/60 Hz
4	220 VAC [230 VAC] 50/60 Hz
5	24 VDC
6	12 VDC

⑨ Electrical entry

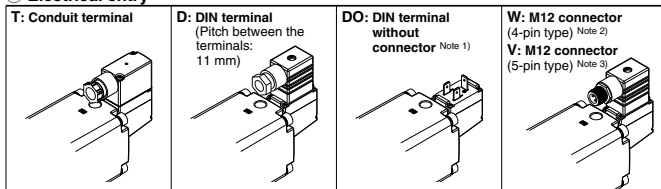

Note 1) Refer to the below table (1) for combinations with light/surge voltage suppressors.
Note 2) Cable is not included. Order it separately after referring to the options on page 522.
Note 3) Only DC voltage is available.

⑩ Light/surge voltage suppressor

Nil	None
S	With surge voltage suppressor (Non-polar)
Z	With light/surge voltage suppressor (Non-polar)

Note) Refer to the below table (1) for combinations with electrical entry.
* DOS, DOZ are not available.
* For AC specifications, Nil is only set for electrical entry DO.

⑪ Manual override

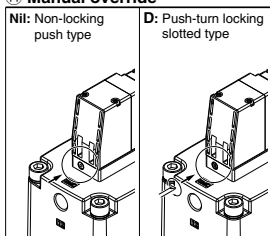

⑫ Bracket

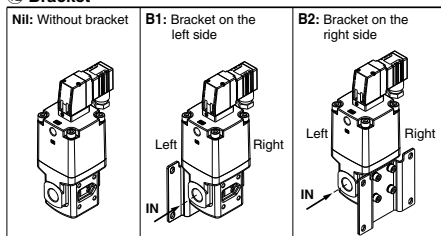

Table (1) Electrical Entry / Light/Surge Voltage Suppressor

Rated voltage	Electrical entry	Without light/surge voltage suppressor	With surge voltage suppressor	With light/surge voltage suppressor
		Nil	S	Z
AC	T		●	●
	D	—	●	●
	W			
	DO	● Note)	—	—
DC	T		●	●
	D	●	●	●
	W, V			
	DO	●	—	—

Note) If an AC specification without DIN terminal (DO) is selected, always use a DIN connector with surge voltage suppressor as the connector.

Options

(For details, refer to page 522.)

Cable for M12 connector

V100-200-1-4

Specifications

4-pin type	1	DC
	2	AC
5-pin type	3	DC

* When selecting the 5-pin type, only DC voltage is available.

Cable length (L)

4	1000 [mm]
8	3000 [mm]
9	5000 [mm]

- VNA
- VNB
- SGC
- SGH
- VNC
- VNH
- VND
- VCC
- TQ

Series SGH



External pilot solenoid



Air operated

How to Order 3-Port Type

Note) Filter is installed on PE port as standard.

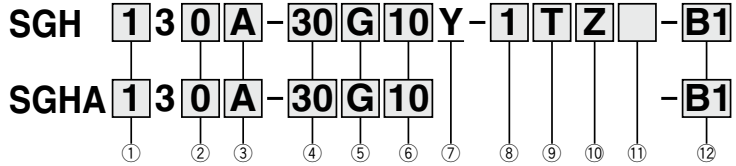

1 Series	2 Valve type	3 Seal material	4 Pressure range	5 Thread type	6 Port size
1 SGH100	0 3-port	A NBR	30 Pressure range 0 to 3 MPa	Nil Rc	10 3/8 SGH100
2 SGH200	3 3-port dual (Note) pressure type	B FKM	70 Pressure range 0 to 7 MPa	G G (ISO1179-1)	15 1/2 SGH200
3 SGH300				N NPT	20 3/4 SGH300
4 SGH400				T NPTF	25 1 SGH400

Note) The flow direction of the fluid is not the same as the arrow on the body.

7 Pilot valve

Y V116

8 Rated voltage

1	100 VAC 50/60 Hz
2	200 VAC 50/60 Hz
3	110 VAC [115 VAC] 50/60 Hz
4	220 VAC [230 VAC] 50/60 Hz
5	24 VDC
6	12 VDC

9 Electrical entry

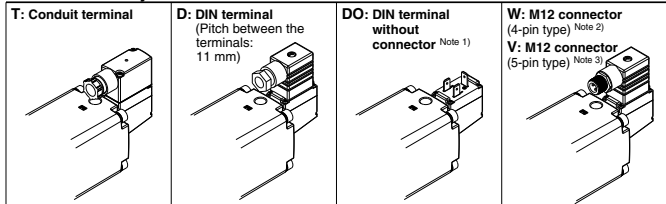

Note 1) Refer to the below table (1) for combinations with light/surge voltage suppressors.
 Note 2) Cable is not included. Order it separately after referring to the options on page 522.
 Note 3) Only DC voltage is available.

10 Light/surge voltage suppressor

Nil	None
S	With surge voltage suppressor (Non-polar)
Z	With light/surge voltage suppressor (Non-polar)

Note) Refer to the below table (1) for combinations with electrical entry.

* DOS, DOZ are not available.
 * For AC specifications, Nil is only set for electrical entry DO.

11 Manual override

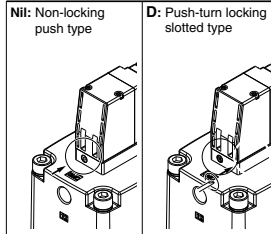

12 Bracket

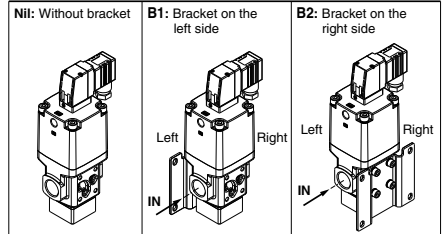

Table (1) Electrical Entry / Light/Surge Voltage Suppressor

Rated voltage	Electrical entry	Without light/surge voltage suppressor	With surge voltage suppressor	With light/surge voltage suppressor
		Nil	S	Z
AC	T			
	D	—	●	●
	W			
	DO	● (Note)	—	—
DC	T			
	D	●	●	●
	W, V			
	DO	●	—	—

Note) If an AC specification without DIN terminal (DO) is selected, always use a DIN connector with surge voltage suppressor as the connector.

Options

(For details, refer to page 522.)

Cable for M12 connector

V100-200-1-4

Specifications	
4-pin type	1 DC
	2 AC
5-pin type	3 DC

* When selecting the 5-pin type, only DC voltage is available.

Cable length (L)	
4	1000 (mm)
8	3000 (mm)
9	5000 (mm)

Flow-rate Characteristics

Port	Pressure specifications	Model	Port size	Orifice diameter ø [mm]		Flow-rate characteristics Av x 10 ⁻⁶ [m ²] (): Cv		Weight [kg]	
				1→2	1→3	1→2	1→3	Without bracket	With bracket
2-port	7 MPa	SGH(A)12□□-70□10	3/8	ø7.5	—	42 (1.8)	—	1.4	1.5
		SGH(A)22□□-70□15	1/2	ø9.4	—	65 (2.7)	—	2.4	2.6
		SGH(A)32□□-70□20	3/4	ø12.4	—	112 (4.7)	—	4.7	5.3
		SGH(A)42□□-70□25	1	ø15.4	—	155 (6.5)	—	6.6	7.2
3-port	3 MPa	SGH(A)13□□-30□10	3/8	ø11	ø9.4	50 (2.1)	56 (2.3)	1.6	1.7
		SGH(A)23□□-30□15	1/2		ø10.5	55 (2.3)	73 (3.0)	1.6	1.7
		SGH(A)33□□-30□20	3/4	ø15	ø12	90 (3.8)	92 (3.8)	2.6	2.8
		SGH(A)43□□-30□25	1	ø17	ø15.2	135 (5.6)	140 (5.8)	4.8	5.4
	7 MPa	SGH(A)13□□-70□10	3/8	ø7.5	ø6	26 (1.1)	23 (1.0)	1.6	1.7
		SGH(A)23□□-70□15	1/2	ø10.1	ø7.6	45 (1.9)	49 (2.0)	2.6	2.8
		SGH(A)33□□-70□20	3/4	ø12.8	ø10	78 (3.3)	65 (2.7)	4.8	5.4
		SGH(A)43□□-70□25	1	ø15.4	ø11.5	102 (4.3)	84 (3.5)	6.4	7.0

Valve Specifications

Fluid	Coolant	
Fluid temperature	-10 to 60°C*	
Ambient temperature	-10 to 50°C*	
Proof pressure	SGH(A)□□□□-30	4.5 MPa
	SGH(A)□□□□-70	10.5 MPa
Leakage from the valve seat	20 cm ³ /min or less (Coolant pressure)	
Operating pressure range	SGH(A)□□□□-30	0 to 3 MPa
	SGH(A)□□□□-70	0 to 7 MPa
Pilot air	Pressure	0.25 to 0.7 MPa
	Lubrication	Not required (Use turbine oil Class 1 (ISO VG32), if lubricated.)
	Temperature	-10 to 50°C*

* No freezing

Symbol

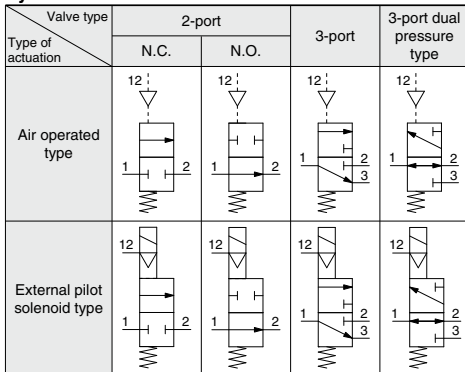

3-Port Dual Pressure Type

Note) The flow direction of the fluid is not the same as the arrow on the body.

① Application example, N.C. type

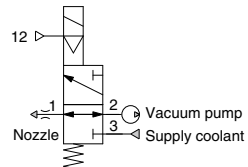

② Application example, Selector type

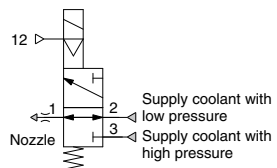

VNA

VNB

SGC

SGH

VNC

VNH

VND

VCC

TQ

How to Order Pilot Valve

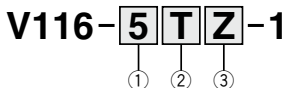

① Rated voltage

1	100 VAC 50/60 Hz
2	200 VAC 50/60 Hz
3	110 VAC [115 VAC] 50/60 Hz
4	220 VAC [230 VAC] 50/60 Hz
5	24 VDC
6	12 VDC

② Electrical entry

T	Conduit terminal
D	DIN terminal (with connector)
DO	DIN terminal (without connector)
W	M12 connector (4-pin type)
V	M12 connector (5-pin type) <small>Note)</small>

Note) Only DC voltage is available.

③ Light/surge voltage suppressor

Nil	None
S	With surge voltage suppressor (Non-polar)
Z	With light/surge voltage suppressor (Non-polar)

Note) Refer to the table (1) on pages 511 and 512 for combinations with electrical entry.

* DOS, DOZ are not available.

* For AC specifications, Nil is only set for electrical entry DO.

Pilot Valve Specifications

Pilot valve specifications		V116-□□□-1	
Electrical entry		Conduit terminal, DIN terminal, M12 connector	
Coil rated voltage V	DC	12 V, 24 V	
	AC (50/60 Hz)	100 V, 110 V, 200 V, 220 V	
Allowable voltage range		±10% of rated voltage*	
Power consumption W	DC	0.35 W (With indicator light: 0.58 W)	
	AC	100 V	0.78 W (With indicator light: 0.87)
110 V [115 V]		0.86 (With indicator light: 0.97) [0.94 (With indicator light: 1.07)]	
200 V		1.15 (With indicator light: 1.30)	
220 V [230 V]		1.27 (With indicator light: 1.46)	
		[1.39 (With indicator light: 1.60)]	
Surge voltage suppressor		ZNR (Varistor)	
Indicator light		LED (Neon bulb when AC with DIN terminal and M12 connector)	
Enclosure		IEC60529 standard IP65, JIS C0920	

* In common between 110 VAC and 115 VAC, and between 220 VAC and 230 VAC.

* For 115 VAC and 230 VAC, the allowable voltage range is -15% to +5% of rated voltage.

Bracket Part No.

Series	Port	Pressure specifications	Part no.
SGH100	2-port	7 MPa	SGH1-16-1A
	3-port	3 MPa	
		7 MPa	
SGH200	2-port	7 MPa	SGH2-16-1A
	3-port	3 MPa	SGH1-16-1A
		7 MPa	SGH2-16-1A
SGH300	2-port	7 MPa	SGH3-16-1A
	3-port	3 MPa	SGH2-16-1A
		7 MPa	SGH3-16-1A
SGH400	2-port	7 MPa	SGH4-16-1A
	3-port	3 MPa	SGH3-16-1A
		7 MPa	SGH4-16-1A

Filter Part No.

Series	Pressure specifications	Thread type	
		Nil/G	N/T
SGH100	3 MPa	EBKX-W4005	EBKY-D8006
	7 MPa		
SGH200	3 MPa		
	7 MPa		
SGH300	3 MPa	EBKX-Z2003	EBKY-D8007
	7 MPa		
SGH400	3 MPa		
	7 MPa		

Construction

2-port valve (N.C.)

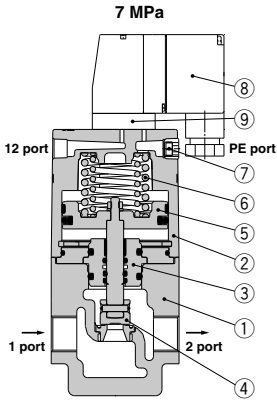

3-port valve

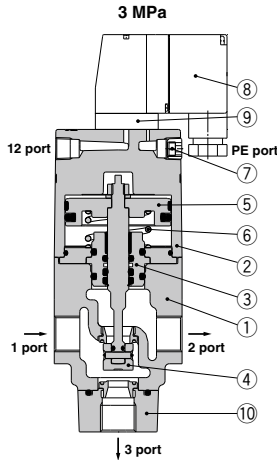

3-port valve (Dual pressure type)

Note) The flow direction of the fluid is not the same as the arrow on the body.

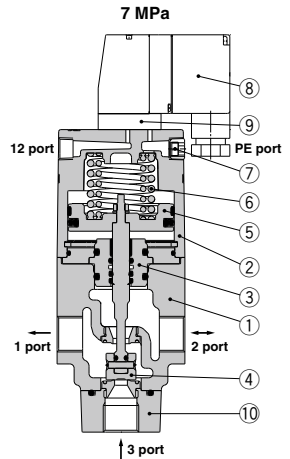
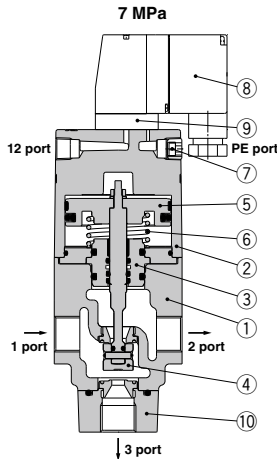
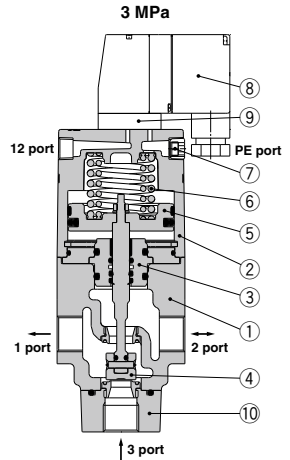

Component Parts

No.	Description	Material	Note
1	Body assembly	Cast iron	Plated
2	Cover	Aluminum die-casted	White
3	Plate assembly	Iron	Valve component, NBR, FKM
4	Valve body	Stainless steel	—
5	Piston assembly	Stainless steel, Aluminum	—
6	Return spring	Stainless steel	—
7	Filter	BC	Replaceable part (Refer to page 514.)
8	Pilot solenoid valve	—	Replaceable part (Refer to page 514.)
9	Adapter plate assembly	—	—
10	Undercover assembly	Cast iron	Plated, only for 3-port valve
—	Bracket	Iron	Replaceable part (Refer to page 514.)

- VNA
- VNB
- SGC
- SGH**
- VNC
- VNH
- VND
- VCC
- TQ

Series SGH

Dimensions: 2-Port, 7 MPa

Air operated type

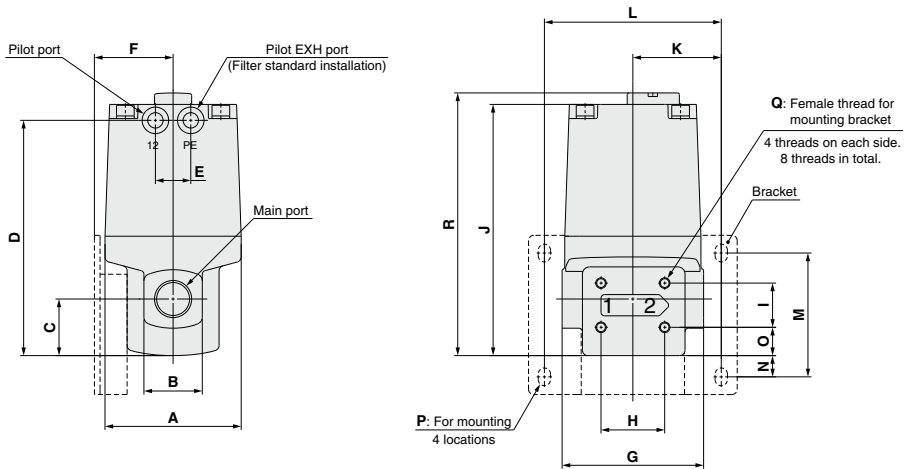

Air Operated Type

Model	Main port	Pilot port	A	B	C	D	E	F	G	H	I	J	K	L	M	N	O
SGHA12□-7010	2 x 3/8	1/8	60	28	29	116	—	34	60	24	29	125	37.5	75	62	10.5	16
SGHA22□-7015	2 x 1/2	1/8	77	33	32	133	20	44.5	80	36	25	142	50	100	70	12	16
SGHA321-7020	2 x 3/4	1/4	96	43	39	157	24	60.5	100	49	34	169	63	126	92	20.5	19
SGHA322-7020	2 x 3/4	1/4	96	43	39	142	24	60.5	100	49	34	154	63	126	92	20.5	19
SGHA421-7025	2 x 1	1/4	113	48	43	173	24	66.5	115	56	38	185	70.5	141	109	31.3	19
SGHA422-7025	2 x 1	1/4	113	48	43	149	24	66.5	115	56	38	161	70.5	141	109	31.3	19

Model	P	Q	R
SGHA12□-7010	For M5	M5	131.5
SGHA22□-7015	For M6	M6	148.5
SGHA321-7020	For M8	M8	175.5
SGHA322-7020	For M8	M8	160.5
SGHA421-7025	For M8	M8	191.5
SGHA422-7025	For M8	M8	167.5

External pilot solenoid type

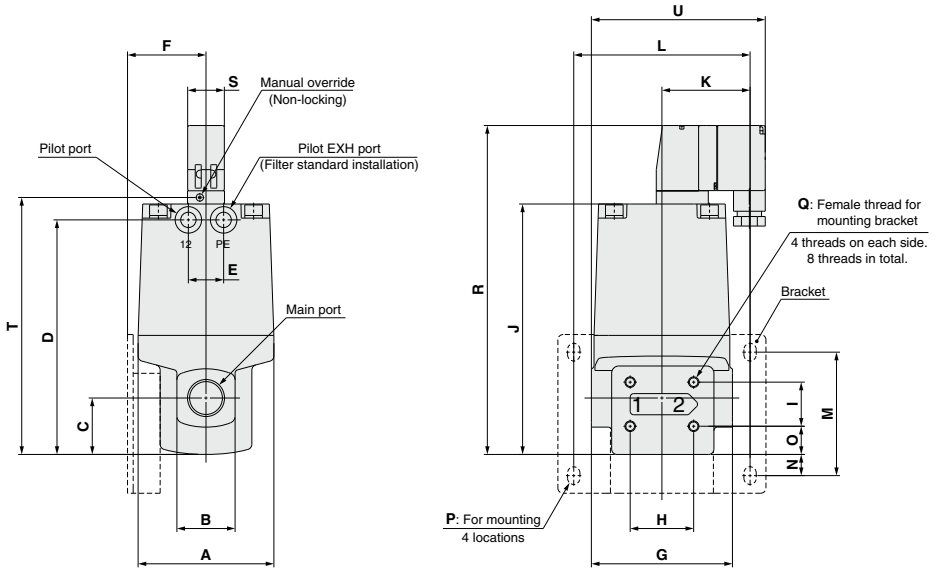

※ Drawing indicates conduit terminal type.

External Pilot Solenoid Type (Conduit terminal)

Model	Main port	Pilot port	A	B	C	D	E	F	G	H	I	J	K	L	M	N	O
SGH12□-7010	2 x 3/8	1/8	60	28	29	116	—	34	60	24	29	125	37.5	75	62	10.5	16
SGH22□-7015	2 x 1/2	1/8	77	33	32	133	20	44.5	80	36	25	142	50	100	70	12	16
SGH321-7020	2 x 3/4	1/4	96	43	39	157	24	60.5	100	49	34	169	63	126	92	20.5	19
SGH322-7020	2 x 3/4	1/4	96	43	39	142	24	60.5	100	49	34	154	63	126	92	20.5	19
SGH421-7025	2 x 1	1/4	113	48	43	173	24	66.5	115	56	38	185	70.5	141	109	31.3	19
SGH422-7025	2 x 1	1/4	113	48	43	149	24	66.5	115	56	38	161	70.5	141	109	31.3	19

Model	P	Q	R	S	T	U
SGH12□-7010	For M5	M5	169.5	20.8	128.7	81.1
SGH22□-7015	For M6	M6	186.5	20.8	145.7	98.6
SGH321-7020	For M8	M8	213.5	20.8	172.7	117.6
SGH322-7020	For M8	M8	198.5	20.8	157.7	117.6
SGH421-7025	For M8	M8	229.5	20.8	188.7	133.6
SGH422-7025	For M8	M8	205.5	20.8	164.7	133.6

External Pilot Solenoid Type (DIN terminal)

Model	U
SGH12□-7010	86.8
SGH22□-7015	104.3
SGH321-7020	123.3
SGH322-7020	123.3
SGH421-7025	139.3
SGH422-7025	139.3

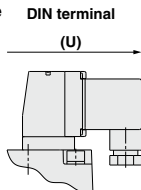

External Pilot Solenoid Type (M12 connector)

Model	U
SGH12□-7010	86.8
SGH22□-7015	104.3
SGH321-7020	123.3
SGH322-7020	123.3
SGH421-7025	139.3
SGH422-7025	139.3

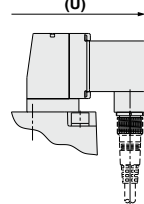

- VNA
- VNB
- SGC
- SGH
- VNC
- VNH
- VND
- VCC
- TQ

Dimensions: 3-Port, 3 MPa/7 MPa

Air operated type

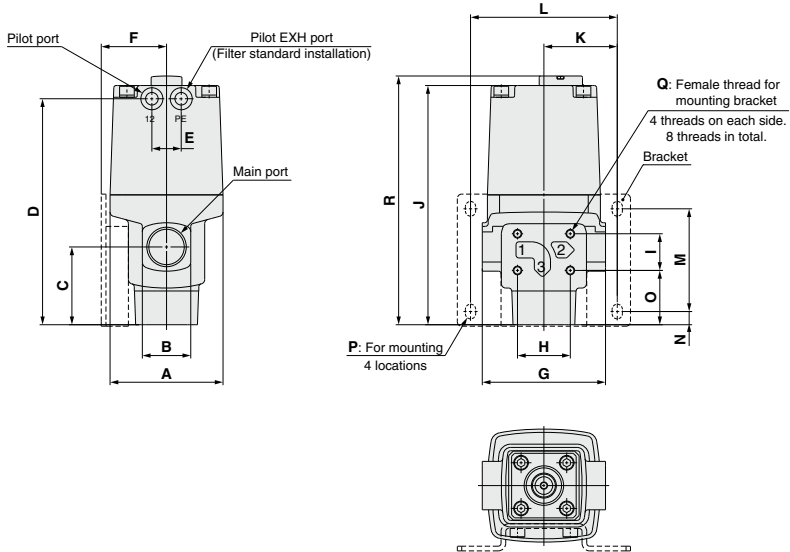

Air Operated Type

Model	Main port	Pilot port	A	B	C	D	E	F	G	H	I	J	K	L	M	N	O
SGHA130-□□10	3 x 3/8	1/8	60	28	46	133	—	34	60	24	29	142	37.5	75	62	6.5	33
SGHA230-3015	3 x 1/2	1/8	60	28	48	135	—	34	65	24	29	144	37.5	75	62	8.5	35
SGHA230-7015	3 x 1/2	1/8	77	36	49	150	20	44.5	80	36	25	159	50	100	70	5	33
SGHA330-3020	3 x 3/4	1/8	77	36	53	154	20	44.5	84	36	25	163	50	100	70	9	37
SGHA330-7020	3 x 3/4	1/4	96	43	60	163	24	60.5	100	49	34	175	63	126	92	0.5	40
SGHA430-3025	3 x 1	1/4	96	43	64.5	167.5	24	60.5	104	49	34	179.5	63	126	92	5	44.5
SGHA430-7025	3 x 1	1/4	113	48	65.5	171.5	24	66.5	115	56	38	183.5	70.5	141	109	—	41.5

Model	P	Q	R
SGHA130-□□10	For M5	M5	148.5
SGHA230-3015	For M5	M5	150.5
SGHA230-7015	For M6	M6	165.5
SGHA330-3020	For M6	M6	169.5
SGHA330-7020	For M8	M8	181.5
SGHA430-3025	For M8	M8	186
SGHA430-7025	For M8	M8	190

External pilot solenoid type

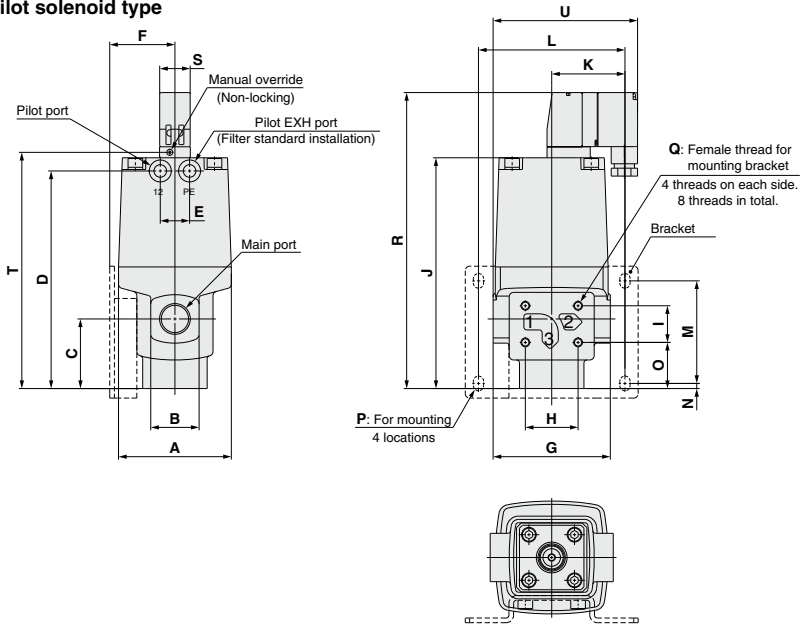

* Drawing indicates conduit terminal type.

External Pilot Solenoid Type (Conduit terminal)

Model	Main port	Pilot port	A	B	C	D	E	F	G	H	I	J	K	L	M	N	O
SGH130-□□10	3 x 3/8	1/8	60	28	46	133	—	34	60	24	29	142	37.5	75	62	6.5	33
SGH230-3015	3 x 1/2	1/8	60	28	48	135	—	34	65	24	29	144	37.5	75	62	8.5	35
SGH230-7015	3 x 1/2	1/8	77	36	49	150	20	44.5	80	36	25	159	50	100	70	5	33
SGH330-3020	3 x 3/4	1/8	77	36	53	154	20	44.5	84	36	25	163	50	100	70	9	37
SGH330-7020	3 x 3/4	1/4	96	43	60	163	24	60.5	100	49	34	175	63	126	92	0.5	40
SGH430-3025	3 x 1	1/4	96	43	64.5	167.5	24	60.5	104	49	34	179.5	63	126	92	5	44.5
SGH430-7025	3 x 1	1/4	113	48	65.5	171.5	24	66.5	115	56	38	183.5	70.5	141	109	—	41.5

Model	P	Q	R	S	T	U
SGH130-□□10	For M5	M5	186.5	20.8	145.7	81.1
SGH230-3015	For M5	M5	188.5	20.8	147.7	83.6
SGH230-7015	For M6	M6	203.5	20.8	162.7	98.6
SGH330-3020	For M6	M6	207.5	20.8	166.7	100.6
SGH330-7020	For M8	M8	219.5	20.8	178.7	117.6
SGH430-3025	For M8	M8	224	20.8	183.2	119.6
SGH430-7025	For M8	M8	228	20.8	187.2	133.6

External Pilot Solenoid Type DIN terminal

Model	U
SGH130-□□10	86.8
SGH230-3015	89.3
SGH230-7015	104.3
SGH330-3020	106.3
SGH330-7020	123.3
SGH430-3025	125.3
SGH430-7025	139.3

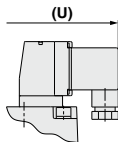

External Pilot Solenoid Type M12 connector

Model	U
SGH130-□□10	86.8
SGH230-3015	89.3
SGH230-7015	104.3
SGH330-3020	106.3
SGH330-7020	123.3
SGH430-3025	125.3
SGH430-7025	139.3

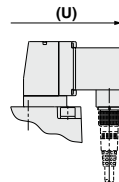

- VNA
- VNB
- SGC
- SGH
- VNC
- VNH
- VND
- VCC
- TQ

Dimensions: 3-Port, 3 MPa/7 MPa, Dual Pressure Type

Air operated type Note) The flow direction of the fluid is not the same as the arrow on the body.

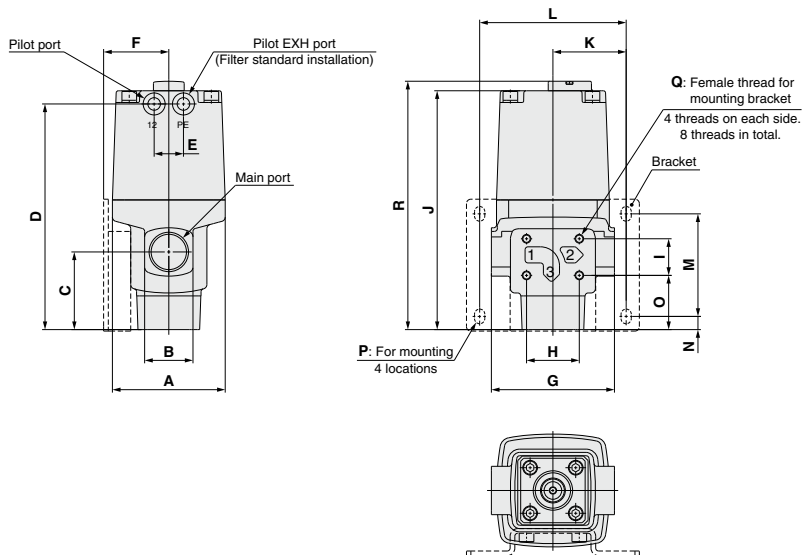

Air Operated Type

Model	Main port	Pilot port	A	B	C	D	E	F	G	H	I	J	K	L	M	N	O
SGHA133-□□10	3 x 3/8	1/8	60	28	46	133	—	34	60	24	29	142	37.5	75	62	6.5	33
SGHA233-3015	3 x 1/2	1/8	60	28	48	135	—	34	65	24	29	144	37.5	75	62	8.5	35
SGHA233-7015	3 x 1/2	1/8	77	36	49	150	20	44.5	80	36	25	159	50	100	70	5	33
SGHA333-3020	3 x 3/4	1/8	77	36	53	154	20	44.5	84	36	25	163	50	100	70	9	37
SGHA333-7020	3 x 3/4	1/4	96	43	60	178	24	60.5	100	49	34	190	63	126	92	0.5	40
SGHA433-3025	3 x 1	1/4	96	43	64.5	182.5	24	60.5	104	49	34	194.5	63	126	92	5	44.5
SGHA433-7025	3 x 1	1/4	113	48	65.5	195.5	24	66.5	115	56	38	207.5	70.5	141	109	—	41.5

Model	P	Q	R
SGHA133-□□10	For M5	M5	148.5
SGHA233-3015	For M5	M5	150.5
SGHA233-7015	For M6	M6	165.5
SGHA333-3020	For M6	M6	169.5
SGHA333-7020	For M8	M8	196.5
SGHA433-3025	For M8	M8	201
SGHA433-7025	For M8	M8	214

External pilot solenoid type Note) The flow direction of the fluid is not the same as the arrow on the body.

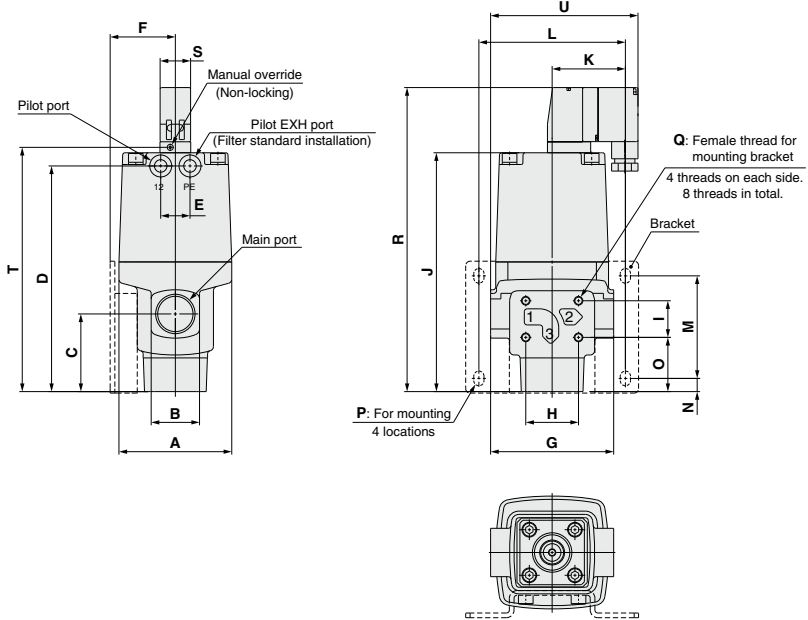

∅ Drawing indicates conduit terminal type.

External Pilot Solenoid Type (Conduit terminal)

Model	Main port	Pilot port	A	B	C	D	E	F	G	H	I	J	K	L	M	N	O
SGH133-□□10	3 x 3/8	1/8	60	28	46	133	—	34	60	24	29	142	37.5	75	62	6.5	33
SGH233-3015	3 x 1/2	1/8	60	28	48	135	—	34	65	24	29	144	37.5	75	62	8.5	35
SGH233-7015	3 x 1/2	1/8	77	36	49	150	20	44.5	80	36	25	159	50	100	70	5	33
SGH333-3020	3 x 3/4	1/8	77	36	53	154	20	44.5	84	36	25	163	50	100	70	9	37
SGH333-7020	3 x 3/4	1/4	96	43	60	178	24	60.5	100	49	34	190	63	126	92	0.5	40
SGH433-3025	3 x 1	1/4	96	43	64.5	182.5	24	60.5	104	49	34	194.5	63	126	92	5	44.5
SGH433-7025	3 x 1	1/4	113	48	65.5	195.5	24	66.5	115	56	38	207.5	70.5	141	109	—	41.5

Model	P	Q	R	S	T	U
SGH133-□□10	For M5	M5	186.5	20.8	145.7	81.1
SGH233-3015	For M5	M5	188.5	20.8	147.7	83.6
SGH233-7015	For M6	M6	203.5	20.8	162.7	98.6
SGH333-3020	For M6	M6	207.5	20.8	166.7	100.6
SGH333-7020	For M8	M8	234.5	20.8	193.7	117.6
SGH433-3025	For M8	M8	239	20.8	198.2	119.6
SGH433-7025	For M8	M8	252	20.8	211.2	133.6

External Pilot Solenoid Type DIN terminal

Model	U
SGH133-□□10	86.8
SGH233-3015	89.3
SGH233-7015	104.3
SGH333-3020	106.3
SGH333-7020	123.3
SGH433-3025	125.3
SGH433-7025	139.3

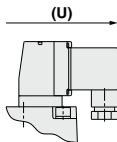

External Pilot Solenoid Type M12 connector

Model	U
SGH133-□□10	86.8
SGH233-3015	89.3
SGH233-7015	104.3
SGH333-3020	106.3
SGH333-7020	123.3
SGH433-3025	125.3
SGH433-7025	139.3

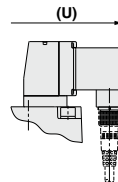

- VNA
- VNB
- SGC
- SGH
- VNC
- VNH
- VND
- VCC
- TQ

Options

Cable for M12 connector (Female connector with cable)

V100-200-**1**-**4**

Specifications

4-pin type	1	DC
	2	AC
5-pin type	3	DC

* When selecting the 5-pin type, only DC voltage is available.

Cable length (L)

4	1000 [mm]
8	3000 [mm]
9	5000 [mm]

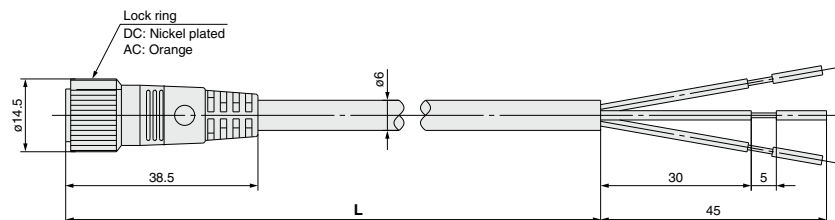

4-pin type

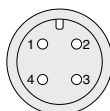

Socket pin connector pin arrangement

5-pin type

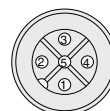

Socket pin connector pin arrangement

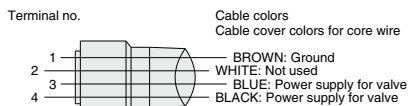

Connections

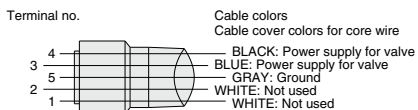

Connections

How to Order

Include the part number of the female connector with cable together with the part number for the solenoid valve.

Example) In case of lead wire length, 1000 mm

W: M12 connector (4-pin type)

- DC
- AC
- SGH221A-7015Y-5WZ
- SGH221A-7015Y-1WZ
- V100-200-1-4
- V100-200-2-4

V: M12 connector (5-pin type)

- SGH221A-7015Y-5VZ
- V100-200-3-4

* When selecting the 5-pin type, only DC voltage is available.

Common for 2-Port and 3-Port

Made to Order

Please contact SMC for detailed dimensions, specifications, and lead times.



Connector entry direction **SGH** **1**^①/**3**^② **1**^③ **A**^④ - **70**^⑤ **G**^⑥ **10**^⑦ **Y**^⑧ - **1**^⑨ **T**^⑩ **Z**^⑪ - **B1**^⑫ -

① to ⑫ are the same as standard. Refer to pages 511 and 512.

Connector entry direction ^{Note}

A	1 port side
B*	Left side mounting
C	Right side mounting

* Mounting direction (R or L) is viewed from the inlet (1) port.

Connector entry direction <A>

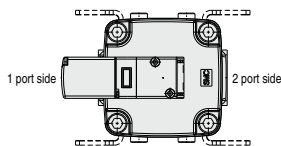

Connector entry direction

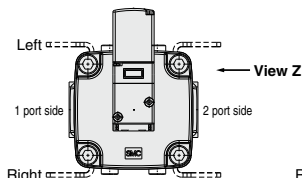

Connector entry direction <C>

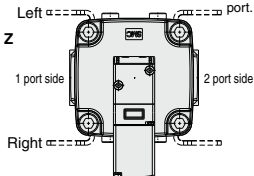

View Z

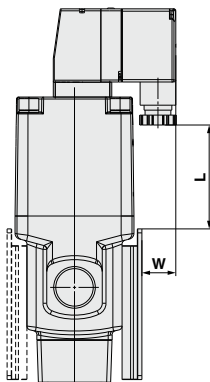

Note) When using a bracket whose direction is the same as that of the pilot valve, ensure that the installation surface does not get in the way of the pilot valve.

Series	Product specifications			T: Conduit terminal		D/DO: DIN terminal		W/W: M12 connector	
				L	W	L	W	L	W
SGH100	2-port	7 MPa	N.C.	52	17	56	22	54	22
			N.O.						
	3-port	3 MPa							
		7 MPa							
3-port dual pressure type	3 MPa								
	7 MPa								
SGH200	2-port	7 MPa	N.C.	59	14	63	19	61	19
			N.O.						
	3-port	3 MPa	52	17	56	22	54	22	
		7 MPa	59	14	63	19	61	19	
	3-port dual pressure type	3 MPa	52	17	56	22	54	22	
		7 MPa	59	14	63	19	61	19	
SGH300	2-port	7 MPa	N.C.	71	7	75	12	73	12
			N.O.						
	3-port	3 MPa	59	14	63	19	61	19	
		7 MPa	56	7	60	12	58	12	
	3-port dual pressure type	3 MPa	59	14	63	19	61	19	
		7 MPa	71	7	75	12	73	12	
SGH400	2-port	7 MPa	N.C.	79	9	83	15	81	15
			N.O.						
	3-port	3 MPa	55	9	59	15	57	15	
		7 MPa	56	7	60	12	58	12	
	3-port dual pressure type	3 MPa	55	9	59	15	57	15	
		7 MPa	79	9	83	15	81	15	

VNA
VNB
SGC
SGH
VNC
VNH
VND
VCC
TQ



Series SGH

Specific Product Precautions 1

Be sure to read before handling.

Refer to front matter 41 for Safety Instructions and pages 17 to 19 for 2 Port Solenoid Valves for Fluid Control Precautions.

Design

⚠ Warning

Extended periods of continuous energization

If a valve is continuously energized for long periods of time, heat generation of the coil may result in reduced performance and shorter service life. This may also have an adverse effect on the peripheral equipment in proximity. Should a valve be continuously energized for long periods of time, or its daily energized state exceeds its non-energized state, please use a valve with DC specifications. Additionally, when using with AC, energizing for long periods of time continuously, select the air-operated valve and use the continuous duty type of the VT307 for a pilot valve.

Manual Override

⚠ Warning

Since connected equipment will be actuated when the manual override is operated, first confirm that conditions are safe.

■ Non-locking push type

Press in the direction of the arrow.

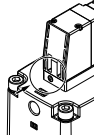

■ Push-turn locking slotted type [D type]

While pressing, turn in the direction of the arrow (90° clockwise). If it is not turned, it can be operated the same way as the non-locking type.

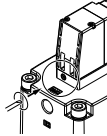

⚠ Caution

When operating the push-turn locking slotted type (D) with a screwdriver, turn it gently using a flat head watchmaker's screwdriver. [Torque: Less than 0.1 N·m]

When locking the manual override on the push-turn locking slotted type (D), be sure to push it down before turning. Turning without first pushing it down can cause damage to the manual override and trouble such as air leakage, etc.

Mounting

⚠ Warning

Avoid mounting the valve vertically facing downwards, otherwise, foreign matter in the coolant will accumulate in the plate assembly which may shorten the product's life.

Wiring

⚠ Caution

1. Applied voltage

When electric power is connected to a solenoid valve, be careful to apply the proper voltage. Improper voltage may cause malfunction or coil damage.

2. Confirm the connections.

After completing the wiring, confirm that the connections are correct.

Leakage Voltage

⚠ Caution

Take note that the leakage voltage will increase when a resistor is used in parallel with switching element or a C-R element (surge voltage suppressor) is used for protecting a switching device because of the passing leakage voltage through the C-R element. The suppressor residual leakage voltage should be as follows.

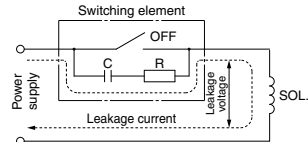

DC coil

3% or less of the rated voltage

AC coil

8% or less of the rated voltage

Operating Environment

⚠ Caution

Products with IP65 enclosure (based on IEC60529) are protected against dust and water, however, these products cannot be used in water.



Series SGH

Specific Product Precautions 2

Be sure to read before handling.

Refer to front matter 41 for Safety Instructions and pages 17 to 19 for 2 Port Solenoid Valves for Fluid Control Precautions.

Light/Surge Voltage Suppressor

⚠ Caution

<DC>

Conduit terminal (Non-polar)

Surge voltage suppressor (TS)

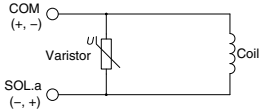

Light/surge voltage suppressor (TZ)

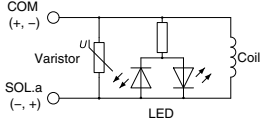

DIN terminal (Non-polar)

Surge voltage suppressor (DS)

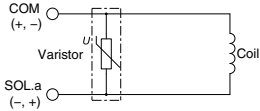

Light/surge voltage suppressor (DZ)

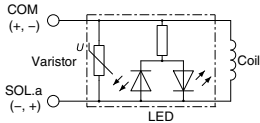

M12 connector (Non-polar)

Surge voltage suppressor (WS/VS)

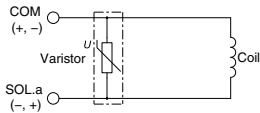

Light/surge voltage suppressor (WZ/VZ)

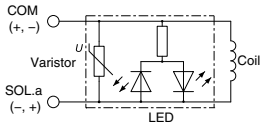

<AC>

Conduit terminal

Surge voltage suppressor (TS)

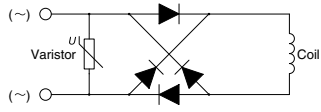

Light/surge voltage suppressor (TZ)

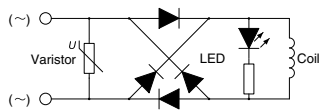

DIN terminal

Surge voltage suppressor (DS)

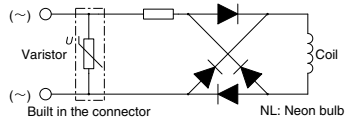

Light/surge voltage suppressor (DZ)

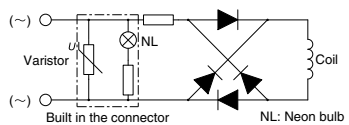

M12 connector

Surge voltage suppressor (WS/VS)

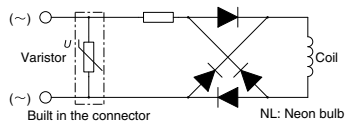

Light/surge voltage suppressor (WZ/VZ)

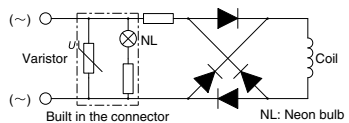

VNA

VNB

SGC

SGH

VNC

VNH

VND

VCC

TQ



Series SGH

Specific Product Precautions 3

Be sure to read before handling.

Refer to front matter 41 for Safety Instructions and pages 17 to 19 for 2 Port Solenoid Valves for Fluid Control Precautions.

M12 Connector

⚠ Caution

1. M12 connector types have an IP65 (enclosure) rating, offering protection from dust and water. However, please note: these products are not intended for use in water.
2. Do not use a tool to mount the connector, as this may cause damage. Only tighten by hand. (0.4 to 0.6 N·m)
3. The excessive stress on the cable connector will not be able to satisfy the IP65 rating. Please use caution and do not apply a stress of 30 N or greater.

Take note that if a connector other than the one stated above is used or if the connector is not tight enough, the IP65 rating will not be satisfied.

M12 connector

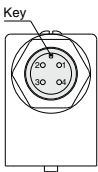

Female connector with cable

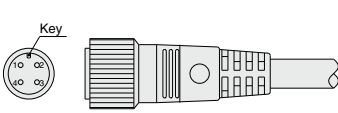

Note) For connecting a female connector with cable, adjust the connector key to the M12 connector key in the valve side since there is an orientation. Be careful not to squeeze it in the wrong direction, as problems such as pin damage may occur.

■ Pin assignment of M12 connector on valve side

4-pin type

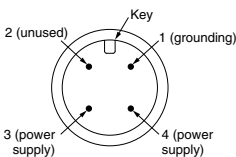

5-pin type

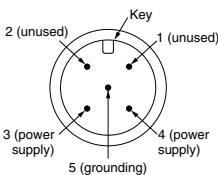

Series	4-pin type		5-pin type	
	DC	AC	DC	AC
SGC	●	● (Note)	●	—
SGH	●	● (Note)	●	—

Note) For AC, surge voltage suppressor or light/surge voltage suppressor is available.

How to Use Conduit Terminal

⚠ Caution

Connection procedure

1. Loosen the holding screw and remove the cover from the terminal block.
2. Loosen the terminal screw in the terminal block. Insert the lead core wires or crimped terminals to the terminals, and secure the wires by re-tightening the terminal screw.
3. Secure the cord by fastening the ground nut.

When making connections, take note that using other than the supported size ($\phi 4.5$ to $\phi 7$) heavy-duty cord will not satisfy IP65 (enclosure) standards. Also, be sure to tighten the ground nut and holding screw within their specified torque ranges.

Compatible cable

Cord O.D.: $\phi 4.5$ to $\phi 7$

(Reference) 0.5 to 1.5 mm², 2-core or 3-core, equivalent to JIS C 3306

Applicable crimped terminals

O-terminals: Equivalent to R1.25-3 defined in the JIS C2805

Y-terminals: Equivalent to 1.25-3 manufactured by J.S.T. Mfg. Co., Ltd.

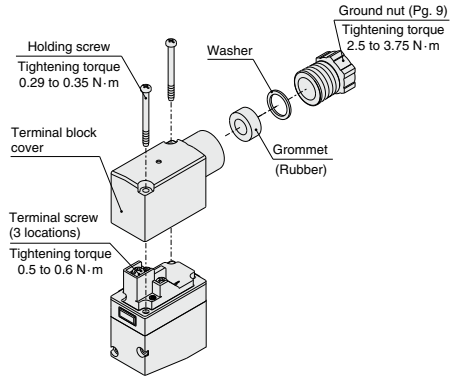



Series SGH

Specific Product Precautions 4

Be sure to read before handling.

Refer to front matter 41 for Safety Instructions and pages 17 to 19 for 2 Port Solenoid Valves for Fluid Control Precautions.

How to Use DIN Terminal

Caution

Connection procedure

1. Loosen the holding screw and pull the connector out of the solenoid valve terminal block.
2. After removing the holding screw, insert a flat head screwdriver, etc. into the notch on the bottom of the terminal block and pry it open, separating the terminal block and the housing.
3. Loosen the terminal screw (slotted screws) in the terminal block. Insert the lead core wires or crimped terminals to the terminals according to the connection method, and secure the wires by re-tightening the terminal screw.
4. Secure the cord by fastening the ground nut.

When making connections, take note that using other than the supported size (ø4.5 to ø7) heavy-duty cord will not satisfy IP65 (enclosure) standards. Also, be sure to tighten the ground nut and holding screw within their specified torque ranges.

Changing the entry direction

After separating the terminal block and housing, the cord entry can be changed by attaching the housing in the opposite direction 180°.

* Be careful not to damage the element, etc. with the cord's lead wires.

Plug in and pull out the connector vertically without tilting to one side.

Compatible cable

Cord O.D.: ø4.5 to ø7

(Reference) 0.5 to 1.5 mm², 2-core or 3-core, equivalent to JIS C 3306

Applicable crimped terminals

O-terminals: Up to R1.25-4M defined in the JIS C2805

Y-terminals: Up to R1.25-3L manufactured by J.S.T. Mfg. Co., Ltd.

Rod-terminals: Up to size 1.5

Ground nut (Pg. 9)

Tightening torque
2.5 to 3.75 N·m



Washer
Grommet
(Rubber)

Holding screw
Tightening torque
0.5 to 0.6 N·m

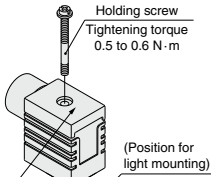

(Position for light mounting)

Terminal block

Terminal screw

(3 locations)
Tightening torque
0.4 to 0.5 N·m

(Rating symbol)
Refer to the table of DIN
connector part number.

DIN Terminal Connector Part No.

DIN Connector Part No.

Without light	DC only	V100-61-1
---------------	---------	-----------

With Surge Voltage Suppressor

Rated voltage	Rating symbol	Part no.
24 VDC	DC 24 VS	V100-61-5-05
12 VDC	DC 12 VS	V100-61-5-06
100 VAC	100/110 VS	V100-61-4-01
200 VAC	200/220 VS	V100-61-4-02
110 VAC	100/110 VS	V100-61-4-01
220 VAC	200/220 VS	V100-61-4-02
240 VAC	240 VS	V100-61-4-07

With Light/Surge Voltage Suppressor

Rated voltage	Rating symbol	Part no.
24 VDC	DC 24 VZ	V100-61-3-05
12 VDC	DC 12 VZ	V100-61-3-06
100 VAC	100/110 VZ	V100-61-2-01
200 VAC	200/220 VZ	V100-61-2-02
110 VAC	100/110 VZ	V100-61-2-01
220 VAC	200/220 VZ	V100-61-2-02
240 VAC	240 VZ	V100-61-2-07

* If an AC specification without DIN terminal (DO) is selected, use a DIN connector with surge voltage suppressor as the connector.

Circuit Diagram with Light/Surge Voltage Suppressor

AC circuit diagram

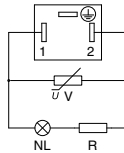

NL: Neon light, R: Resistor
V: Varistor

DC circuit diagram

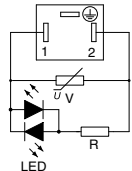

LED: Light emitting diode, R: Resistor
V: Varistor

VNA

VNB

SGC

SGH

VNC

VNH

VND

VCC

TQ