

## Piloted check valves HGL

**FESTO**



Festo core product range  
Covers 80% of your automation tasks

Worldwide:  
Superb:  
Easy:

Always in stock  
Festo quality at an attractive price  
Simplified procurement and warehousing

★ Generally ready for shipping ex works in 24 hours  
In stock at 13 Service Centres worldwide  
More than 2200 products

★ Generally ready for shipping ex works in 5 days  
Assembled for you at 4 Service Centres worldwide  
Up to  $6 \times 10^{12}$  variants per product family

Just look  
for the  
star!

## Product range overview and type codes

### Product range overview

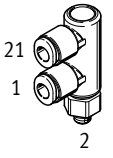
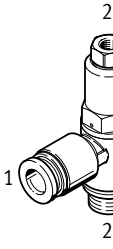
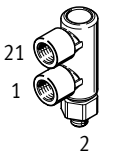
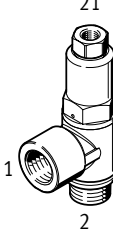
Valve function	Design	Pneumatic connection 1	Pneumatic connection 2	Pilot air connection 21	q <sub>nN</sub> [l/min]	→ Page/Internet	
Piloted non-return function		QS-4	M5	QS-4	130	3	
			QS-4, QS-6, QS-8, QS-10, QS-12	G1/8, G1/4, G3/8, G1/2	M5, G1/8, G1/4, G3/8	200 ... 1400	3
	Female thread		M5	M5	M5	130	6
				M5, G1/8, G1/4, G3/8, G1/2	M5, G1/8, G1/4, G3/8, G1/2	M5, G1/8, G1/4, G3/8	300 ... 1600

### Type codes

001	Series
<b>HGL</b>	Piloted check valve

002	Pneumatic connection 2
<b>M5</b>	Male thread M5
<b>1/8</b>	Male thread G1/8
<b>1/4</b>	Male thread G1/4
<b>3/8</b>	Male thread G3/8
<b>1/2</b>	Male thread G1/2

003	Pneumatic connection 1
	Connection size as for port 1 or 2
<b>QS-4</b>	Push-in connector 4 mm
<b>QS-6</b>	Push-in connector 6 mm
<b>QS-8</b>	Push-in connector 8 mm
<b>QS-10</b>	Push-in connector 10 mm
<b>QS-12</b>	Push-in connector 12 mm



  

004	Generation
	None
<b>B</b>	Series B

## Data sheet – Push-in connector

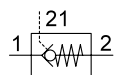
### Function



-  - Flow rate  
130 ... 1400 l/min
-  - Temperature range  
-10 ... +60°C
-  - Operating pressure  
0.5 ... 10 bar



The piloted check valve is suitable for brief positioning and braking functions in pneumatic drives.

Compressed air flows to and from the drive as long as a control signal is applied to pneumatic connection 21. If

no control signal is applied, the valve shuts off the exhaust air from the drive in flow direction 2 → 1 and the movement of the drive is stopped.

- Proven component suitable for use in safety-related systems
- Swivel joint can be turned after mounting
- Manual exhausting of air trapped in the cylinder with manual override HAB as an accessory → page 9

**Note**

If used in safety-related applications, additional measures are necessary, e.g. in Europe the standards listed under the EC Machinery Directive must be observed.

Without additional measures in accordance with legally specified minimum requirements, the product is not suitable as a safety-related component in control systems.

General technical data		M5	G1/8	G1/4	G3/8	G1/2
Pneumatic connection 2		M5	G1/8	G1/4	G3/8	G1/2
Pneumatic connection 1		QS-4	QS-4, QS-6	QS-8, QS-10	QS-8, QS-10	QS-12
Pilot air connection 21		QS-4	M5	G1/8	G1/4	G3/8
Valve function		Piloted non-return function				
Actuation type		Pneumatic				
Type of mounting		Screw-in, via male thread				
Mounting position		Any				
Nominal tightening torque [Nm]		1.25 ±10%	3.5 ±10%	11 ±10%	12.5 ±10%	14 ±10%

† Note: This product conforms to ISO 1179-1 and ISO 228-1.

Operating and environmental conditions		M5	G1/8	G1/4	G3/8	G1/2
Operating pressure for entire temperature range [bar]		0.5 ... 10				
Pilot pressure [bar]		2 ... 10			1 ... 10	
Operating/pilot medium		Compressed air to ISO 8573-1:2010 [7:4:4]				
Note on the operating/pilot medium		Lubricated operation possible (in which case lubricated operation will always be required)				
Ambient temperature [°C]		-10 ... +60				
Temperature of medium [°C]		-10 ... +60				
Storage temperature [°C]		-10 ... +60				
Corrosion resistance class CRC <sup>1)</sup>		2				
Maritime classification		See certificate <sup>2)</sup>				

- 1) Corrosion resistance class CRC 2 to Festo standard FN 940070  
Moderate corrosion stress. Indoor applications in which condensation can occur. External visible parts with primarily decorative surface requirements which are in direct contact with a normal industrial environment.
- 2) Additional information is available at [www.festo.com/sp](http://www.festo.com/sp) → Certificates.

Data sheet – Push-in connector

Minimum pilot pressure p21 as a function of operating pressure p1

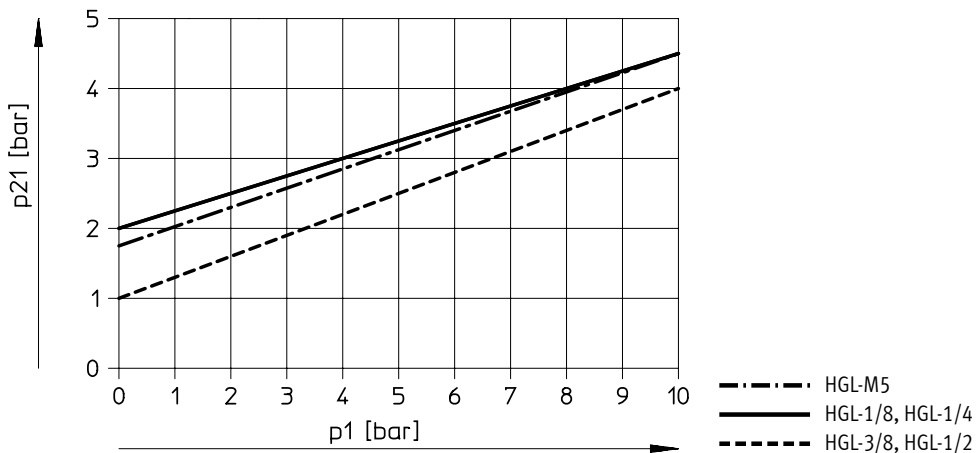

Materials

Sectional view

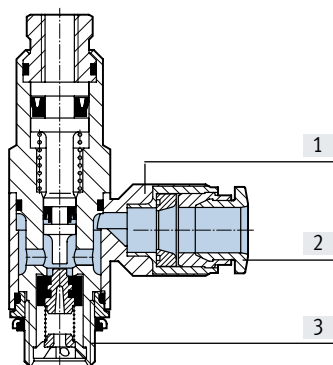

Piloted check valve	
[1] Swivel joint	Die-cast zinc
[2] Releasing ring	POM
[3] Hollow bolt	Anodised wrought aluminium alloy
- Seals, non-return collar	NBR
Note on materials	RoHS-compliant
	Free of copper and PTFE

## Data sheet – Push-in connector

### Dimensions

Download CAD data → [www.festo.com](http://www.festo.com)

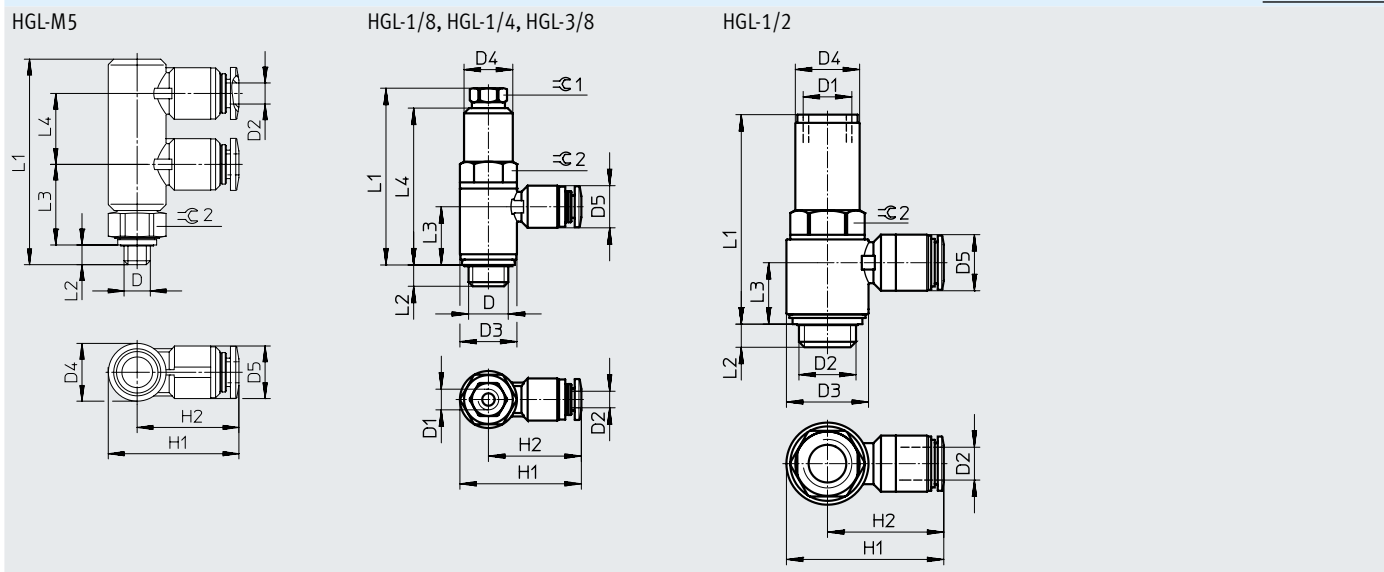

Type	D	D1	D2	D3 ∅	D4 ∅	D5 ∅	H1	H2	L1	L2	L3	L4	∅1	∅2
HGL-M5-QS-4	M5	–	4	–	11	10	24.9	19.4	39	4	15	13.5	–	10
HGL-1/8-QS-4	G1/8	M5	4	13.8	11.8	10.2	29.4	22.5	42.6	5.4	13.9	37.8	8	12
HGL-1/8-QS-6			6			12.5					13.2			
HGL-1/4-QS-8	G1/4	G1/8	8	17.8	16	14.5	39.6	30.7	50.8	6.5	16.6	44.5	12	16
HGL-1/4-QS-10			10			17.5					42			
HGL-3/8-QS-8	G3/8	G1/4	8	22.4	18.8	14.5	44.1	32.9	56.3	7	18.2	49.5	15	19
HGL-3/8-QS-10			10			17.5					35.5			
HGL-1/2-QS-12	G1/2	G3/8	12	27.8	23.5	20.5	55.3	41.4	75.8	8.8	22.4	–	–	24

† Note: This product conforms to ISO 1179-1 and ISO 228-1.

### ★ Core product range

#### Ordering data

	Pneumatic connection		Pilot air connection	Standard nominal flow rate qnN at 6 bar → 5 bar [l/min]	Standard flow rate qn at 6 bar → 0 bar [l/min]	Weight [g]	Part no.	Type
	2	1	21					
	M5	QS-4	QS-4	130	200	21	★ 530038	HGL-M5-QS-4 <sup>1)</sup>
	G1/8	QS-4	M5	200	300	18.4	★ 530039	HGL-1/8-QS-4 <sup>1)</sup>
		QS-6	M5	270	400	21.4	★ 530040	HGL-1/8-QS-6 <sup>1)</sup>
	G1/4	QS-8	G1/8	390	640	38.7	★ 530041	HGL-1/4-QS-8 <sup>1)</sup>
		QS-10	G1/8	400	670	45	★ 530042	HGL-1/4-QS-10 <sup>1)</sup>
	G3/8	QS-8	G1/4	830	1200	54.7	★ 530043	HGL-3/8-QS-8 <sup>1)</sup>
		QS-10	G1/4	890	1300	60.3	★ 530044	HGL-3/8-QS-10 <sup>1)</sup>
G1/2	QS-12	G3/8	1400	2100	116.9	★ 530045	HGL-1/2-QS-12 <sup>1)</sup>	

1) Sealing ring for male thread is included in the scope of delivery.



Festo core product range

- ★ Generally ready for shipping ex works in 24 hours
- ★ Generally ready for shipping ex works in 5 days

## Data sheet – Female thread

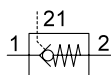
Function



-  - Flow rate  
130 ... 1600 l/min
-  - Temperature range  
-10 ... +60°C
-  - Operating pressure  
0.5 ... 10 bar



The piloted check valve is suitable for brief positioning and braking functions in pneumatic drives.

Compressed air flows to and from the drive as long as a control signal is applied to pneumatic connection 21. If

no control signal is applied, the valve shuts off the exhaust air from the drive in flow direction 2 → 1 and the movement of the drive is stopped.

- Proven component suitable for use in safety-related systems
- Swivel joint can be turned after mounting
- Manual exhausting of air trapped in the cylinder with manual override HAB as an accessory → page 9

 **Note**

If used in safety-related applications, additional measures are necessary, e.g. in Europe the standards listed under the EC Machinery Directive must be observed.

Without additional measures in accordance with legally specified minimum requirements, the product is not suitable as a safety-related component in control systems.

**General technical data**

Pneumatic connection 2	M5	G1/8	G1/4	G3/8	G1/2
Pneumatic connection 1	M5	G1/8	G1/4	G3/8	G1/2
Pilot air connection 21	M5	M5, G1/8	G1/8	G1/4	G3/8
Valve function	Piloted non-return function				
Actuation type	Pneumatic				
Type of mounting	Screw-in, via male thread				
Mounting position	Any				
Nominal tightening torque [Nm]	1.25 ±10%	3.5 ±10%	11 ±10%	12.5 ±10%	14 ±10%

† Note: This product conforms to ISO 1179-1 and ISO 228-1.

**Operating and environmental conditions**

Pneumatic connection 2	M5	G1/8	G1/4	G3/8	G1/2
Operating pressure for entire temperature range [bar]	0.5 ... 10				
Pilot pressure [bar]	2 ... 10			1 ... 10	
Operating/pilot medium	Compressed air to ISO 8573-1:2010 [7:4:4]				
Note on the operating/pilot medium	Lubricated operation possible (in which case lubricated operation will always be required)				
Ambient temperature [°C]	-10 ... +60				
Temperature of medium [°C]	-10 ... +60				
Storage temperature [°C]	-10 ... +60				
Corrosion resistance class CRC <sup>1)</sup>	2				
Maritime classification	See certificate <sup>2)</sup>				

- 1) Corrosion resistance class CRC 2 to Festo standard FN 940070  
Moderate corrosion stress. Indoor applications in which condensation can occur. External visible parts with primarily decorative surface requirements which are in direct contact with a normal industrial environment.
- 2) Additional information is available at [www.festo.com/sp](http://www.festo.com/sp) → Certificates.

## Data sheet – Female thread

### Minimum pilot pressure $p_{21}$ as a function of operating pressure $p_1$

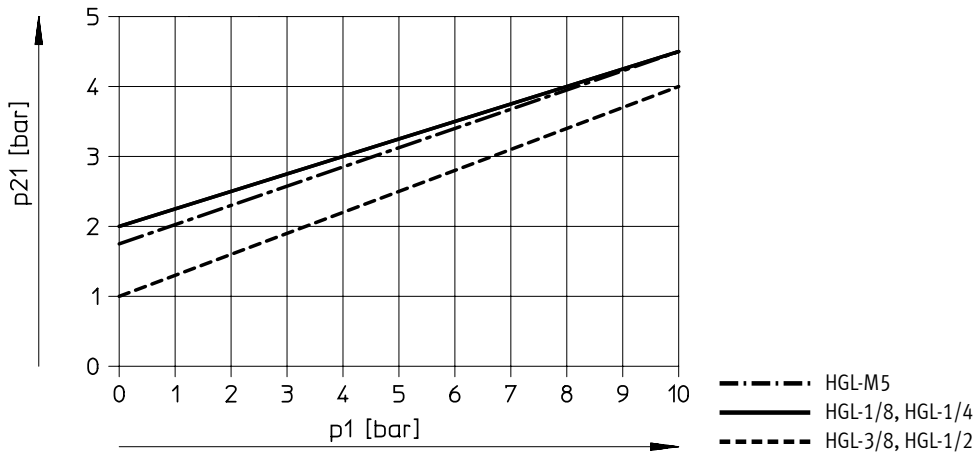

### Materials

Sectional view

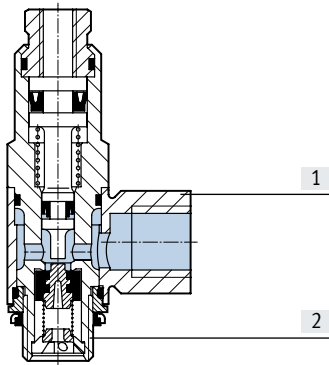

Piloted check valve	
[1] Swivel joint	Die-cast zinc
[2] Hollow bolt	Anodised wrought aluminium alloy
- Seals, non-return collar	NBR
Note on materials	RoHS-compliant
	Free of copper and PTFE

Data sheet – Female thread

Dimensions

Download CAD data → [www.festo.com](http://www.festo.com)

HGL-M5-B

HGL-1/8-B, HGL-1/4-B, HGL-3/8-B

HGL-1/8-1/8-B

HGL-1/2-B

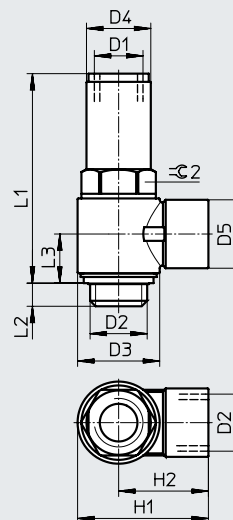
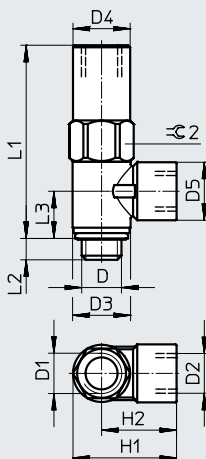
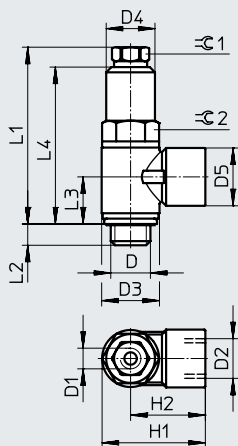
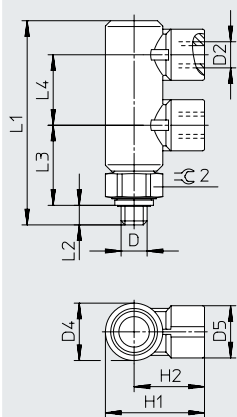

Type	D	D1	D2	D3	D4	D5	H1	H2	L1	L2	L3	L4	∅ 1	∅ 2
HGL-M5-B	M5	-	M5	-	11	10	19	13.5	39	4	15	13.5	-	10
HGL-1/8-B	G1/8	M5	G1/8	14	11.8	14	25.1	18.1	42.6	5.4	11.2	37.8	8	12
HGL-1/8-1/8-B	G1/8	G1/8	G1/8	14	13.8	14	25.1	18.1	46.7	5.2	11.2	-	-	14
HGL-1/4-B	G1/4	G1/8	G1/4	18	16	17.5	34	25	50.8	6.5	13.5	44.5	12	16
HGL-3/8-B	G3/8	G1/4	G3/8	23.8	18.8	20	39.3	27.4	56.3	7	15.1	49.5	15	19
HGL-1/2-B	G1/2	G3/8	G1/2	30	23.5	25	47.8	32.8	75.8	8.8	17.7	-	-	24

† Note: This product conforms to ISO 1179-1 and ISO 228-1.

★ Core product range

Ordering data	Pneumatic connection		Pilot air connection	Standard nominal flow rate qnN at 6 bar → 5 bar [l/min]	Standard flow rate qn at 6 bar → 0 bar [l/min]	Weight [g]	Part no.	Type
	2	1	21					
	M5	M5	M5	130	200	21	★ 530029	HGL-M5-B <sup>1)</sup>
	G1/8	G1/8	M5	300	430	20.8	★ 530030	HGL-1/8-B <sup>1)</sup>
			G1/8	300	430	26.2	★ 543253	HGL-1/8-1/8-B <sup>1)</sup>
	G1/4	G1/4	G1/8	550	680	41.2	★ 530031	HGL-1/4-B <sup>1)</sup>
	G3/8	G3/8	G1/4	1100	1500	62.9	★ 530032	HGL-3/8-B <sup>1)</sup>
	G1/2	G1/2	G3/8	1600	2100	129.4	★ 530033	HGL-1/2-B <sup>1)</sup>

1) Sealing ring for male thread is included in the scope of delivery.

Festo core product range

- ★ Generally ready for shipping ex works in 24 hours
- ★ Generally ready for shipping ex works in 5 days



## Accessories

### Manual override HAB

For check valve HGL

- For manual exhausting of air trapped in a cylinder

Material:

Housing: Anodised wrought aluminium alloy

Note on materials:

RoHS-compliant



General technical data		G1/8	G1/4	G3/8	G1/2
Pneumatic connection 2		G1/8	G1/4	G3/8	G1/2
Pneumatic connection 1		G1/8	G1/4	G3/8	G1/2
Nominal size	[mm]	4.1	7	11	14
Valve function		Exhaust component			
Type of mounting		Screw-in			
Mounting position		Any			
Standard flow rate exhaust	[l/min]	165			
6 → 0 bar					
Max. tightening torque	[Nm]	4	11	40	50

Operating and environmental conditions	
Operating pressure	[bar] 0 ... 10
Operating medium	Compressed air to ISO 8573-1:2010 [7:4:4]
Note on the operating/pilot medium	Lubricated operation possible (in which case lubricated operation will always be required)
Ambient temperature	[°C] -20 ... +80
Temperature of medium	[°C] -20 ... +80
Corrosion resistance class CRC <sup>1)</sup>	2

1) Corrosion resistance class CRC 2 to Festo standard FN 940070

Moderate corrosion stress. Indoor applications in which condensation can occur. External visible parts with primarily decorative surface requirements which are in direct contact with a normal industrial environment.

## Dimensions

Download CAD data → [www.festo.com](http://www.festo.com)

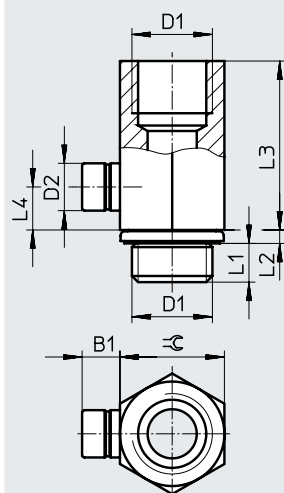

Dimensions and ordering data										
Connection	B1	D1	D2 ø	L1	L2	L3	L4	⊕	Part no.	Type
G1/8	6.2	G1/8	7.7	4.7	1.8	19.1	5	13	184585	HAB-1/8
G1/4	6.2	G1/4	7.7	5.8	2.2	28	7	17	184586	HAB-1/4
G3/8	6.2	G3/8	7.7	6.05	3.35	28.4	7	19	184587	HAB-3/8
G1/2	6.2	G1/2	7.7	7.9	2.6	38.5	7	24	184588	HAB-1/2

† Note: This product conforms to ISO 1179-1 and ISO 228-1.