

Valve terminals CPV-SC, Smart Cubic

FESTO



Valve terminals CPV-SC, Smart Cubic

Key features

FESTO



Innovative

- Small, compact valve terminal for a wide range of pneumatic applications
- Enormous flexibility during planning, assembly and operational use
- Multi-pin plug connection
- Wide range of selectable valve functions; 5/2-way, 3/2-way and 2/2-way functions
- With flow rates of up to 170 l/min, CPV-SC offers outstanding pneumatic performance for a wide range of applications
- Low weight

Versatile

- Provides 2 ... 16 valve positions on one terminal
- Ideally suited for operating small pneumatic drives in tight spaces
- The flexibility of the pneumatic working ports provides a practical solution to different requirements
- Round silencers, integrated flat plate silencers or screw/plug connection for ducted exhaust air
- Suitable for vacuum
- Enables multiple pressure zones on a single valve terminal

Reliable

- Manual override
- Durable thanks to the use of tried and tested piston spool valves
- Sturdy thanks to metal housing and connecting thread
- Fast troubleshooting thanks to an LED on each valve and diagnostics via fieldbus

Easy to mount

- Fully assembled and tested valve terminal
- Less complicated when ordering, installing and commissioning
- Suitable for direct mounting even on moving system components

Valve terminals CPV-SC, Smart Cubic

Key features

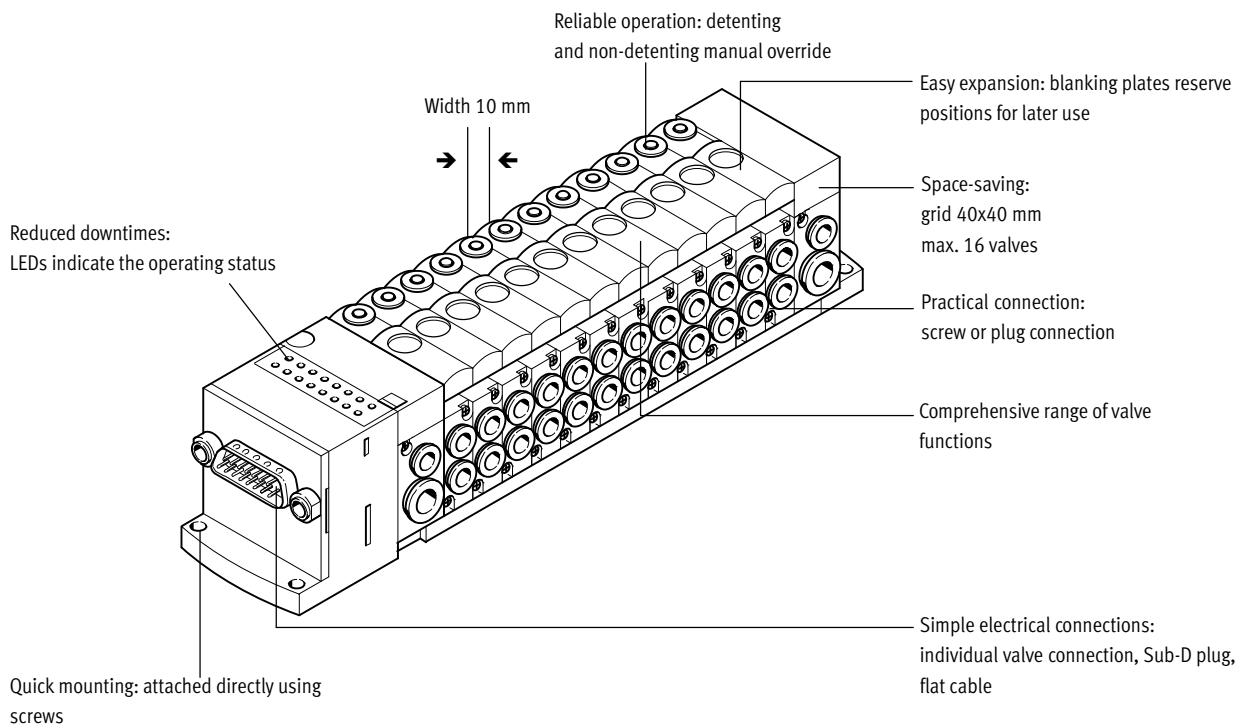

Equipment options

Valve functions

- 5/2-way valve, single solenoid
- 5/2-way valve, double solenoid
- 3/2-way valve, normally open
- 3/2-way valve, normally closed
- 2/2-way valve, normally closed

Separator plate with additional compressed air supply

- Compressed air channel (1) closed
- Compressed air channel (1) and exhaust duct (3/5) closed

Blanking plate

- Plate without valve function for reserving a valve position

Electrical connection options

Individual connection

- 2 ... 16 valve positions/ max. 16 solenoid coils
- Individual connection, horizontal (H)
- Individual connection, vertical (T)

Multi-pin plug

- 4 ... 16 valve positions/ max. 16 solenoid coils
- Sub-D
- Flat cable

Valve terminals CPV-SC, Smart Cubic

Key features



Valve terminal configurator

Online via: → www.festo.com

Selecting a CPV-SC valve terminal using the online catalogue is quick and easy thanks to the convenient valve terminal configurator provided. This makes it much easier to order the right product. The valve terminals are assembled according to your order specifications and are individually tested. This reduces the assembly and installation time to a minimum. The valve terminal CPV-SC is ordered using the order code.

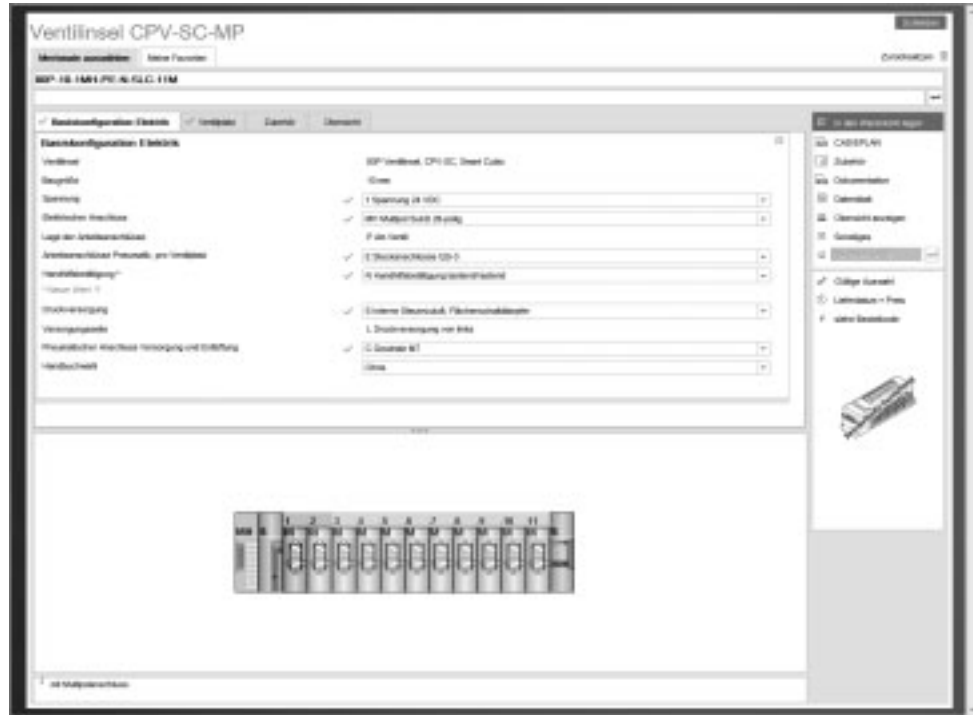

Ordering system for CPV-SC

→ Internet: cpv-sc

2D/3D CAD data

Online via: → www.festo.com

You can request the CAD data for a valve terminal you have configured. To do so, perform the product search as described above. Go to the shopping

basket and click on the CAD icon. On the next page you can generate a 3D preview or request another data format of your choice by e-mail.

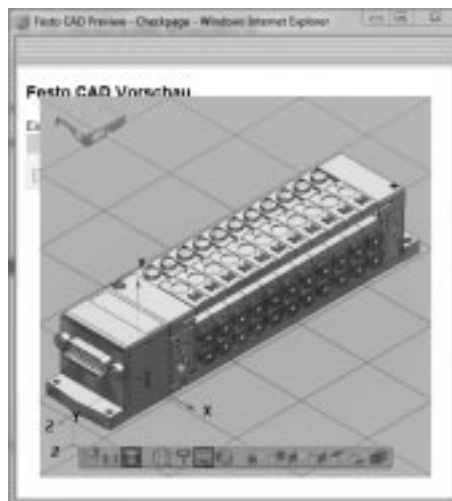

Valve terminals CPV-SC, Smart Cubic

Key features

Individual connection

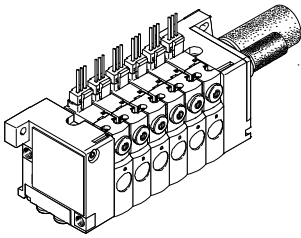

Connection is independent of the control technology used and is flexible thanks to ready to install cables. This ensures correct polarity during installation.

Valves with integrated LED (CPVSC1-M1LH- ...) are available as an option for switching status display. Individual connection permits the selection of 2 to 16 solenoid coils (divided between 2 to 16 valve positions).

Variants

- Individual connection, horizontal
- Individual connection, vertical
- 2 to 16 solenoid coils

Multi-pin plug connection

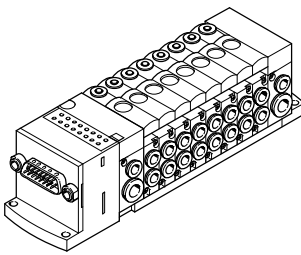

Control signals to the valve terminal are transmitted via a pre-assembled multi-core cable, which substantially reduces installation time.

The multi-pin plug connection enables the selection of 4 to 16 solenoid coils (divided between 4 to 16 valve positions).

Variants

- Sub-D connection
- Flat cable connection
- 4 to 16 solenoid coils

Valve terminals CPV-SC, Smart Cubic

Peripherals overview

Overview – CPV-SC valve terminal

Valve terminal with individual electrical connections

- Vertical individual connection
Code: T
 - Horizontal individual connection
Code: H
- Valve terminals with individual electrical connection can be equipped with 2 to max. 16 valve positions.
- Each valve position can either be equipped with a valve or a blanking plate.

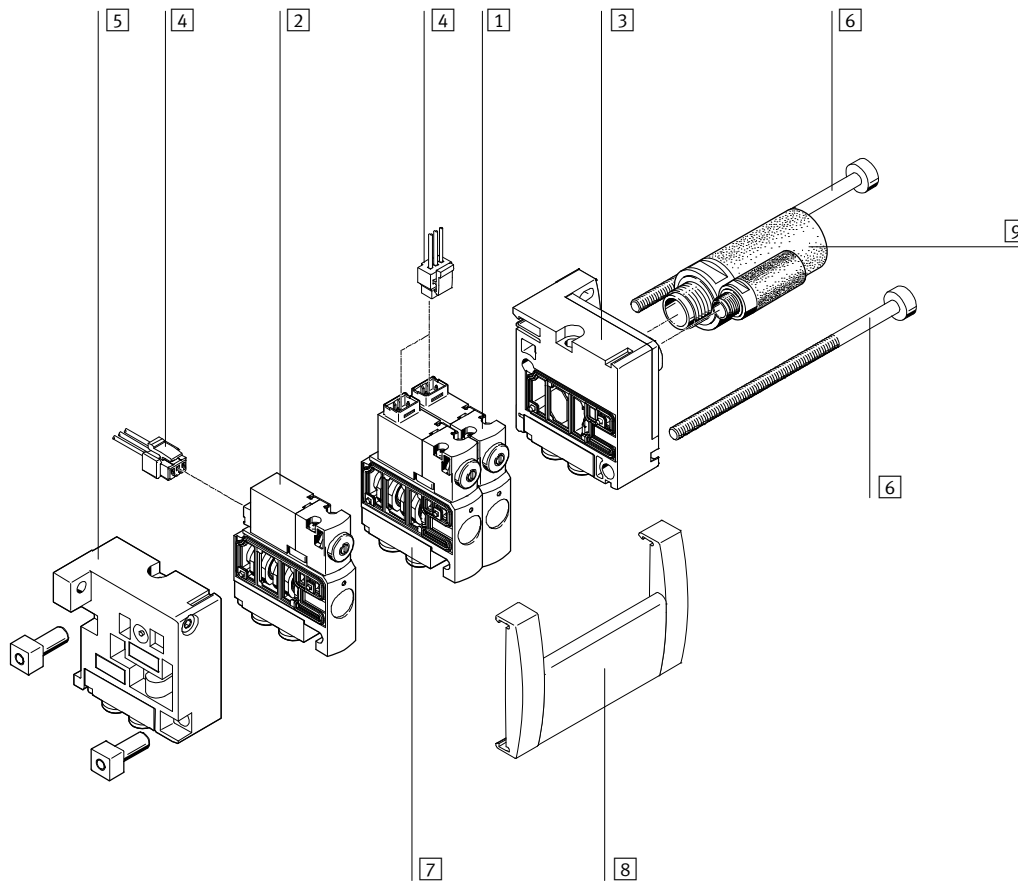

- | | | | |
|--|---|--|----------------------------|
| 1 Valve with vertical individual connection | 4 Plug socket with cable for individual electrical connection of the valves | 6 Tie rod | 8 Inscription label holder |
| 2 Valve with horizontal individual connection | 5 Left-hand end plate for compressed air supply 1 or 12/14 | 7 Sub-base for working ports (push-in fitting or thread) | 9 Pneumatic silencer |
| 3 Right-hand sub-base for unducted exhaust air | | | |

Valve terminals CPV-SC, Smart Cubic

Peripherals overview

Valve terminal with electrical multi-pin plug connection

- 15-pin and 26-pin Sub-D multi-pin plug connection
Code: MS, MH
- or
- 20-pin multi-pin plug connection with connector for flat cable
Code: MF

Valves and end plates are the basic pneumatic components of the valve terminal.
The valve terminals are connected to the end plates using tie rods.

Valve terminals with electrical multi-pin plug connection can be equipped with 4 to max. 16 valve positions.
Each valve position can either be equipped with a valve or a blanking plate.

The electrical connection is located on the left-hand side, thereby allowing particularly flush installation of the system.

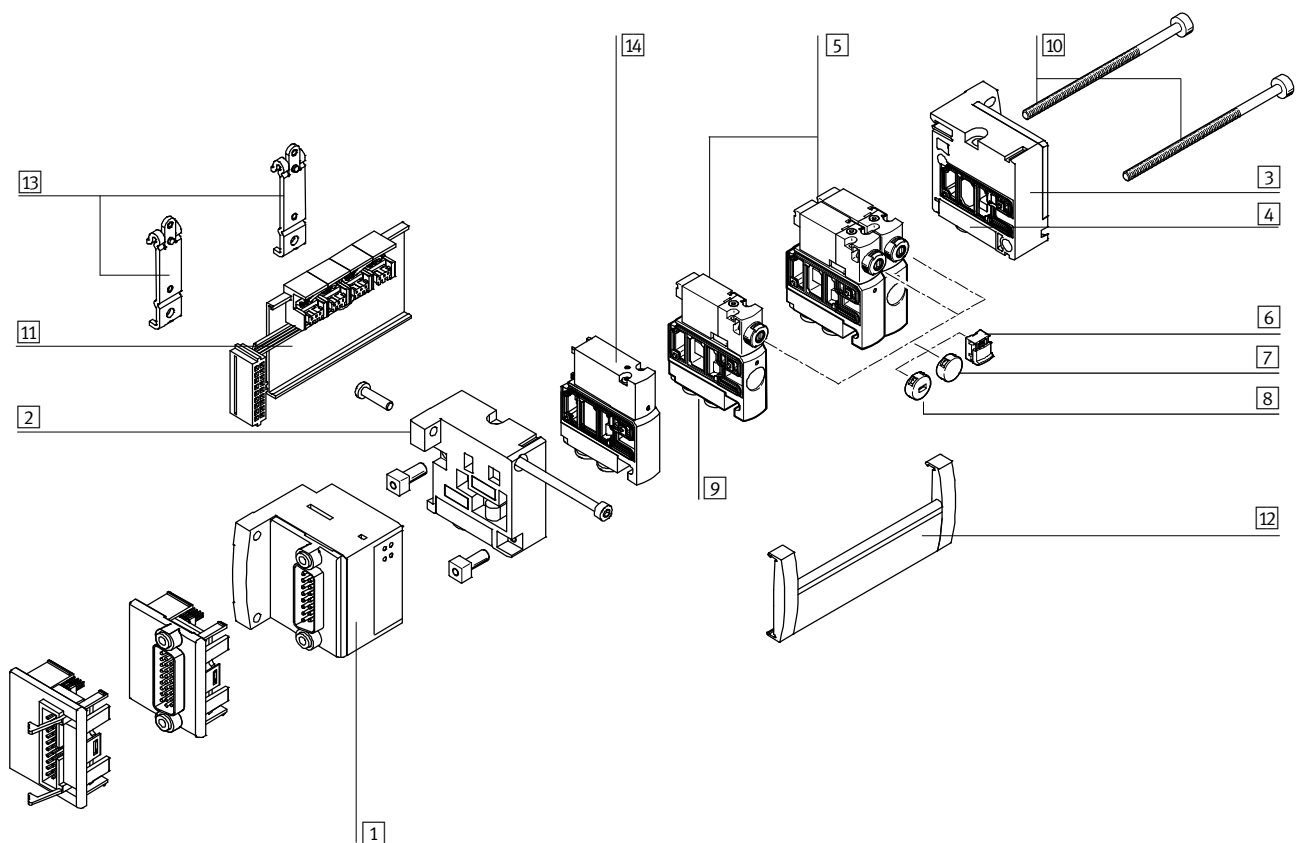

- | | | | |
|---|---|---|---|
| <p>1 Electrical control unit (with LED switching status indications) for Sub-D plug connector or flat cable</p> <p>2 Left-hand end plate for compressed air supply 1 or 12/14</p> <p>3 Right-hand end plate for ducted exhaust air or pneumatic silencer (3/5 or 82/84)</p> | <p>4 Sub-base for ducted exhaust air (push-in fitting or thread)</p> <p>5 Valve</p> <p>6 Cover cap, MO manually operated without accessories (code Y)</p> | <p>7 Cover cap for manual override, MO blocked (code V)</p> <p>8 Cover cap coded, MO non-detenting (code K)</p> <p>9 Sub-base for working ports (push-in fitting or thread)</p> | <p>10 Tie rod</p> <p>11 Electrical valve linking module</p> <p>12 Inscription label holder</p> <p>13 H-rail mounting</p> <p>14 Blanking plate for vacant position</p> |
|---|---|---|---|

Valve terminals CPV-SC, Smart Cubic

Key features – Pneumatic components





Valves

CPVSC1 valves are valves with integrated sub-base, i.e. in addition to the valve function they contain all of the ducts for supply, exhaust and the

working ports. The supply ducts are a central component of the valve slices and enable a direct flow of air. This helps achieve maximum flow rates. All

valves have a pneumatic pilot control for optimising performance. The valve function is based on a piston spool system with a patented sealing prin-

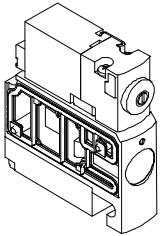
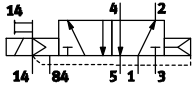
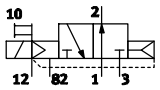
ciple that guarantees its suitability for a wide range of applications as well as a long service life.

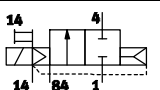
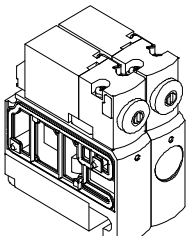
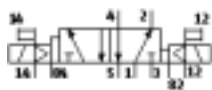
Valve functions	Code	Circuit symbol	Valve size 10 mm	Description
	M		■	5/2-way single solenoid valve <ul style="list-style-type: none"> • Pneumatic spring return
	N		■	3/2-way single solenoid valve <ul style="list-style-type: none"> • Normally open • Pneumatic spring return
	K		■	3/2-way single solenoid valve <ul style="list-style-type: none"> • Normally closed • Pneumatic spring return
	D		■	2/2-way single solenoid valve <ul style="list-style-type: none"> • Normally closed • Pneumatic spring return
	J		■	5/2-way double solenoid valve This valve consists of two valve housing units and therefore occupies two valve positions. The pilot control with coil 12 is located on the left and labelled "J12". If both coils are actuated, the signal at port "14" dominates in switching position.

-  - Note

For vacuum operation valves require a filter. This is to avoid that foreign matter is drawn into the valve (e.g. when using a suction cup).

Valve terminals CPV-SC, Smart Cubic

Key features – Pneumatic components

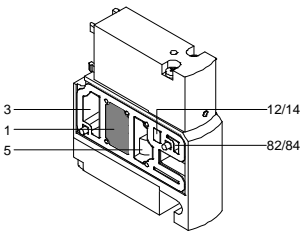
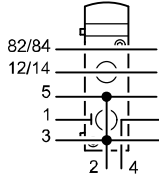
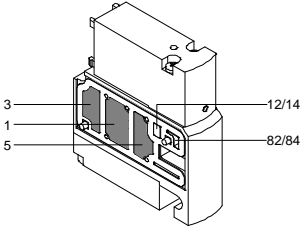
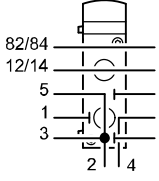
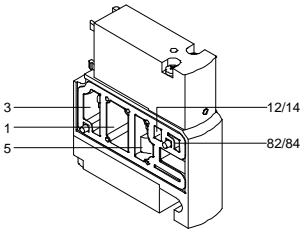
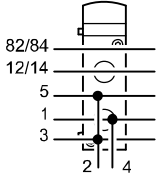
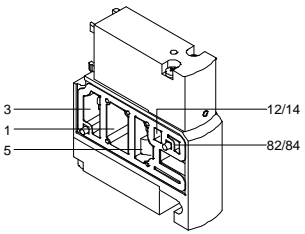
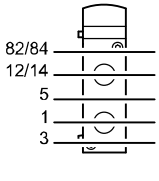
Valves				
Valve functions	Code	Circuit symbol	Valve size 10 mm	Description
Pneumatic supply plate with duct separation				
	T		■	Compressed air channel (1) closed For separating pressure zones with a common exhaust. (Using pressure zones → 11) Pneumatic connection: QS-4, M5
	S		■	Compressed air channel (1) and exhaust duct (3/5) closed For separating pressure zones with a separate exhaust. (Using pressure zones → 11) Pneumatic connection: QS-4, M5
Pneumatic supply plate without duct separation				
	U		■	Additional compressed air supply (1) and additional exhaust (3/5). Pneumatic connection: QS-4, M5
Blanking plate				
	L		■	Plate without valve function for reserving a valve position. No pneumatic connection

In the case of compressed air supply configuration code S or T (exhausting via flat plate silencer), a plug-in silencer UC-QS-4H is included with supply plates.

Valve terminals CPV-SC, Smart Cubic

Key features – Pneumatic components



Constructional design

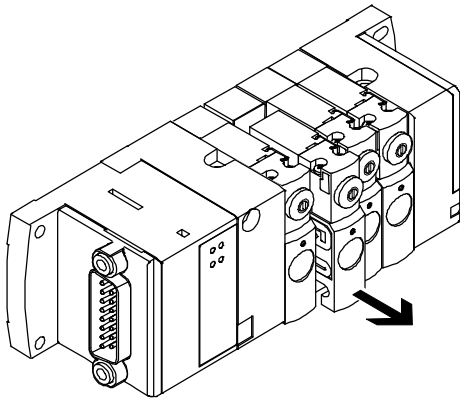

Valve replacement

Valves can be replaced quickly and easily in just a few movements. Separating seals between the valves are based on a metal support and are secured in place.

Extension

Valves can be ordered as accessories and are available with fully assembled sub-bases with QS or threaded connections. The functionality of the valve terminal can therefore be extended by equipping vacant positions. For ordering purposes, valves have the valve code printed on the front and the product type on the back.

Materials

The valve housing and thread in the sub-bases are metallic, while other housing sections are made from robust plastic materials.



Note

The valve with the working sub-base has been tested by Festo for leak tightness.

Pilot air supply

The port for the main pneumatic supply is located on the left-hand end plate.

The ports differ for the following types of pilot air supply:

- Internal
- External

Internal pilot air supply

An internal pilot air supply can be selected if the terminal is working in an operating pressure range between 3 and 7¹⁾ bar.

The pilot air supply in the left-hand end plate is then branched from the compressed air supply 1 using an internal connection. The port 12/14 is closed using a blanking plug.

External pilot air supply

If the terminal is working in an operating pressure range from -0.9 to 3 bar, you must operate your CPV-SC valve terminal using an external pilot air supply. The pilot air supply is also supplied via port 12/14 on the left-hand end plate in this case.

1) 8 bar upon request

Creation of pressure zones and separation of exhaust air

The CPV-SC valve terminal can be operated with multiple pressure zones. After two zones, a supply with duct separation is required for each subsequent pressure zone. It always

occupies one valve position. An isolating disc T separates the compressed air supply of a valve group on the left from the compressed air supply of a valve group on the right. The right-

hand pressure zone is supplied at port 4 of the supply plate. Port 2 also allows the left-hand pressure zone to be exhausted. All of the exhaust ducts of the valve are interconnected and

are exhausted through the right-hand end plate. An isolating disc S also separates exhaust ducts 3 and 5 in addition to pressure duct 1.

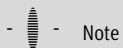

Note

Larger or simultaneously operating cylinders generate a back pressure in the exhaust duct of the valve terminal, the level of which depends on the exhaust capacity of the silencer.

In order to prevent interaction with adjacent valves, valves can be separated by means of duct separation using isolating disc S. The pressure zone located to the left of an isolating

disc S is exhausted using the supplied plug-in silencer. Where there are more than two valves in such a pressure zone, an additional supply with additional exhaust may be required.

It is therefore useful to meet the higher exhaust requirements in the pressure zone that is exhausted by the right-hand end plate.

Valve terminals CPV-SC, Smart Cubic

Key features – Pneumatic components

Creating pressure zones		
	Code	Description
	S	Duct 1 and 3/5 separated
	T	Duct 1 separated

Pneumatic working ports		
	Code	Description
Working port		
	B	M5 threaded connection
	E	QS-3 push-in connector
	F	QS-4 push-in connector
Supply port, left-hand end plate		
	C	Threaded connection <ul style="list-style-type: none"> • M7 (internal pilot air supply) • M5 and M7 (external pilot air supply)
	G	Push-in connection <ul style="list-style-type: none"> • QS-6 (internal pilot air supply) • QS-4 and QS-6 (external pilot air supply)

Valve terminals CPV-SC, Smart Cubic

Key features – Pneumatic components

Ports for supply and exhaust

Supply and exhaust

A basic feature of a CPV-SC valve terminal are the two end plates.

The left-hand end plate is used to supply compressed air, while the right-hand end plate is used to exhaust the valve terminal.

Exhaust air escapes either via an integrated flat plate silencer, round silencer or via a push-in or threaded connection.

Ports for exhaust

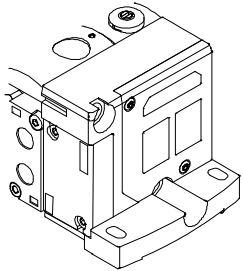
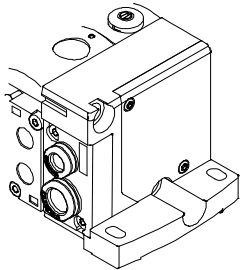
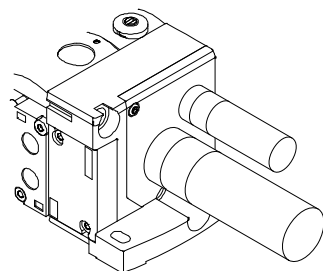
	Code	Description
	S	<ul style="list-style-type: none"> Internal pilot air supply Exhaust from duct 3/5 as well as 82/84 is via a flat plate silencer Replacement part (insert) for flat plate silencer: Type CPVSC1-UA
	T	<ul style="list-style-type: none"> External pilot air supply Exhaust from duct 3/5 as well as 82/84 is via a flat plate silencer Replacement part (insert) for flat plate silencer: Type CPVSC1-UA
	V	<ul style="list-style-type: none"> Internal pilot air supply Exhaust from duct 3/5 as well as 82/84 is via ducted exhaust air
	X	<ul style="list-style-type: none"> External pilot air supply Exhaust from duct 3/5 as well as 82/84 is via ducted exhaust air
	Y	<ul style="list-style-type: none"> Internal pilot air supply Exhaust from duct 3/5 as well as 82/84 is via a round silencer
	Z	<ul style="list-style-type: none"> External pilot air supply Exhaust from duct 3/5 as well as 82/84 is via a round silencer

Valve terminals CPV-SC, Smart Cubic

Key features – Pneumatic components



Pneumatic supply			Code	Description
End plate combination				
			S	Internal pilot air supply, flat plate silencer For operating pressure in the range 3 ... 7 bar
			T	External pilot air supply, flat plate silencer For operating pressure in the range -0.9 ... +7 bar
			V	Internal pilot air supply, ducted exhaust air For operating pressure in the range 3 ... 7 bar
			X	External pilot air supply, ducted exhaust air For operating pressure in the range -0.9 ... +7 bar
			Y	Internal pilot air, round silencer For operating pressure in the range 3 ... 7 bar
			Z	External pilot air supply, round silencer For operating pressure in the range -0.9 ... +7 bar

Valve terminals CPV-SC, Smart Cubic

Key features – Electrical components



Protective circuit

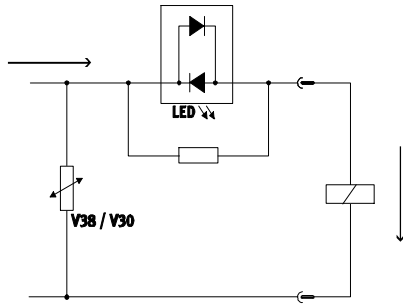

Each solenoid coil is protected with a spark arresting protection circuit as well as against polarity reversal.

Electrical multi-pin plug connection

The following multi-pin plug connection types are offered for the valve terminal CPV-SC:

- Sub-D multi-pin plug connection (15- and 26-pin) or
- Multi-pin plug connection with connector for flat cable (20-pin)

CPV-SC is connected via a multi-pin plug connection with Sub-D or flat cable. Each pin of the multi-pin plug is assigned a maximum of one valve position and therefore one coil or one address.

Double solenoid valves “J” occupy two valve positions. The left-hand valve position with pilot control 12 is actuated by the less significant of the two addresses.

Electrical multi-pin plug connection – Sub-D

Code MS, MH

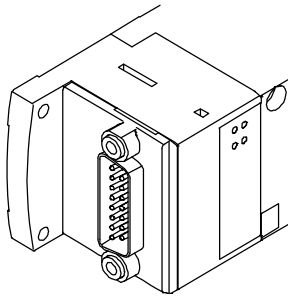



With this electrical connection variant, all valves are centrally actuated via the 15 and 26-pin connector plug. The electrical connection is located on the left-hand side.

Ordering data – Connecting cable Sub-D

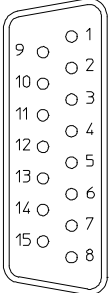

	Code	Description	Cable length [m]	Part No.	Type
	CP	15-pin for 12 coils (code MS) Material: PVC	2.5	527543	KMP6-15P-12-2,5
	CQ		5	527544	KMP6-15P-12-5
	CR		10	527545	KMP6-15P-12-10
	CP	26-pin for 16 coils (code MH) Material: PVC	2.5	527546	KMP6-26P-16-2,5
	CQ		5	527547	KMP6-26P-16-5
	CR		10	527548	KMP6-26P-16-10

Valve terminals CPV-SC, Smart Cubic

Key features – Electrical components

Pin allocation for 15-pin Sub-D (code MS)				
KMP6-15P-12-...	Description	Pin	Core colour	Address/coil
	Plug socket with cable for the CPV-SC valve terminal with max. 12 valve positions  Note The drawing shows a plan view of the Sub-D socket on the multi-pin cable KMP6-15P-12-....	1	White	Coil 0
		2	Brown	Coil 1
		3	Green	Coil 2
		4	Yellow	Coil 3
		5	Grey	Coil 4
		6	Pink	Coil 5
		7	Blue	Coil 6
		8	Red	Coil 7
		9	Black	Coil 8
		10	Purple	Coil 9
		11	Grey-pink	Coil 10
		12	Red-blue	Coil 11
		13	White-green	n.c.
		14	Brown-green	0 V ¹⁾
		15	White-yellow	0 V ¹⁾

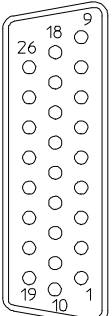
1) Pin 14 to pin 15 are bridged in the valve terminal.
0 V for positive switching control signals; 24 V can be connected for negative switching control signals.

Pin allocation for 26-pin Sub-D (code MH)				
KMP6-26P-16-...	Description	Pin	Core colour	Allocation
	Plug socket with cable for the CPV-SC valve terminal with 16 valve positions  Note The drawing shows a plan view of the Sub-D socket on the multi-pin cable KMP6-26P-12-....	1	White	Coil 0
		2	Brown	Coil 1
		3	Green	Coil 2
		4	Yellow	Coil 3
		5	Grey	Coil 4
		6	Pink	Coil 5
		7	Blue	Coil 6
		8	Red	Coil 7
		9	Black	Coil 8
		10	Purple	Coil 9
		11	Grey-pink	Coil 10
		12	Red-blue	Coil 11
		13	White-green	Coil 12
		14	Brown-green	Coil 13
		15	White-yellow	Coil 14
		16	Yellow-brown	Coil 15
		17	–	n.c.
		18	–	n.c.
		19	–	n.c.
		20	–	n.c.
		21	–	n.c.
		22	–	n.c.
		23	White-grey	0 V ¹⁾
		24	Grey-brown	0 V ¹⁾
		25	White-pink	0 V ¹⁾
		26	Pink-brown	0 V ¹⁾

1) Pin 17 to pin 22 are bridged in the valve terminal.
0 V for positive switching control signals; 24 V can be connected for negative switching control signals.

Valve terminals CPV-SC, Smart Cubic

Key features – Electrical components

Electrical multi-pin plug connection – Connector for flat cable

Code MF

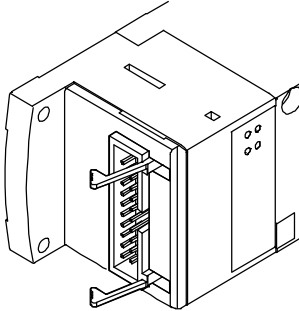

With this electrical connection variant, all valves are centrally actuated via the 20-pin connector plug. The electrical connection is located on the left-hand side.

Pin allocation – Connector for flat cable (code MF)

	Pin	Allocation
	1	Coil 0
	2	Coil 1
	3	Coil 2
	4	Coil 3
	5	Coil 4
	6	Coil 5
	7	Coil 6
	8	Coil 7
	9	Coil 8
	10	Coil 9
	11	Coil 10
	12	Coil 11
	13	Coil 12
	14	Coil 13
	15	Coil 14
	16	Coil 15
	17	0 V ¹⁾
	18	0 V ¹⁾
	19	0 V ¹⁾
	20	0 V ¹⁾

CPV-SC valve terminal with up to 16 valve positions and 20-pin multi-pin socket for flat cables to DIN 41561-1, -2 or IEC 60603-13-C020FD-7C1E-2G

Contact surface gold
Flat cable grid 1.27 mm
Conductor cross section 0.13 mm²

1) Pin 17 to pin 20 are bridged in the valve terminal.

Valve terminals CPV-SC, Smart Cubic

Key features – Electrical components

Address allocation – Solenoid coils

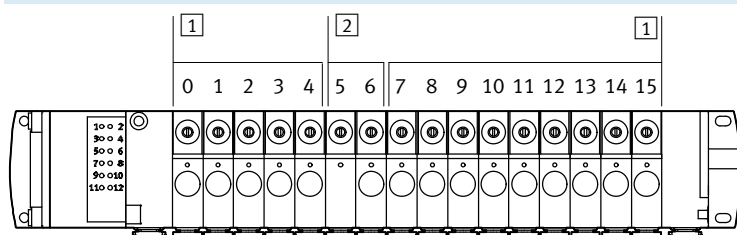

Example:

Valve terminal where valve positions 5 and 6 are prepared for double solenoid valves.

1 Single solenoid valves occupy one valve position

2 Double solenoid valves occupy two valve positions

The addresses of the valve positions on the CPV-SC are assigned from left to right. Each valve position has an address, regardless of whether or not a valve is mounted there.

Double solenoid valves “J” occupy two valve positions. The left-hand valve position with pilot control 12 is actuated by the less significant of the two addresses.

Valve terminals CPV-SC, Smart Cubic

Key features – Display and operation

Display and operation

The switching status of every solenoid coil is displayed on the control unit LED. Inscription labels (type MH-BZ-80x) can be applied to each valve for labelling purposes.

The manual override (MO) allows the valve to be activated without electronic control or power supply. The valve is activated by pushing the manual override. The set switching status can also be secured by rotating the manual override.

The cover cap (detenting without accessories, code Y) can be used to operate the manual override without any aids.

A cover can be fitted over the manual override to prevent it from being activated accidentally (code V).

 Note

A manually activated valve (manual override) cannot be reset electrically. Conversely, an electrically activated valve cannot be reset using the manual override facility.

Manual override (MO)

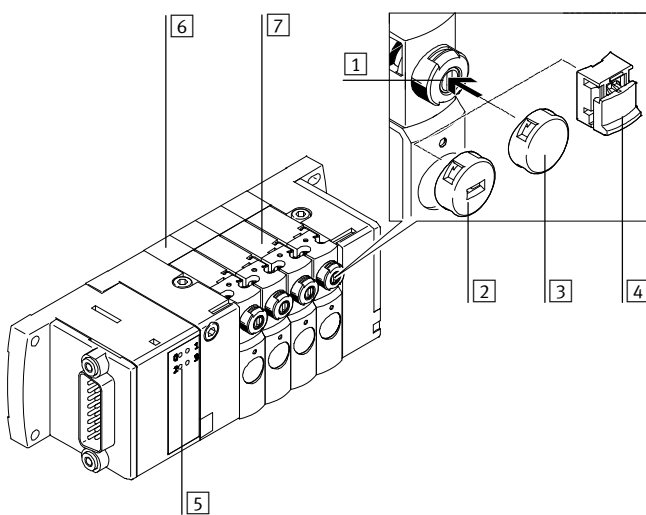

- 1 Manual override, MO non-detenting and turning with detent (code N – without cover cap)
- 2 Cover cap coded, MO non-detenting (code K – with coded cover cap)
- 3 Cover cap for manual override, MO blocked (code V)

- 4 Cover cap, MO manually operated without accessories (code Y – with cover cap)
- 5 LED signal status indication for each valve position
- 6 Numbering of valve positions
- 7 Location for valve position inscription label (type MH-BZ-80x)

MO with automatic return (non-detenting), code N – without cover cap

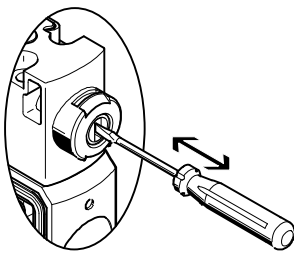

Manual override is actuated by pushing it with a pin or screwdriver and reset by spring force.

MO with lock (detenting), code N – without cover cap

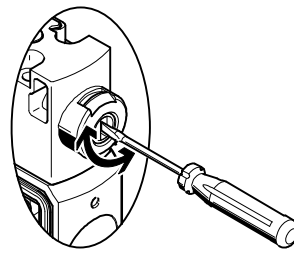

Manual override remains active until it is reset with a screwdriver.

MO with automatic return (non-detenting), code K – with coded cover cap

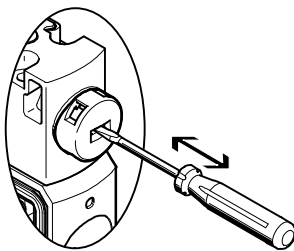

Manual override is actuated by pushing it with a pin or screwdriver and reset by spring force (detenting position prevented due to coded cover cap).

MO with lock (detenting without accessories), code Y – with cover cap

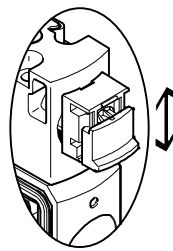

Manual override remains active until it is reset manually (without any aids).

Valve terminals CPV-SC, Smart Cubic

Key features – Display and operation

Display and operation

Multi-pin

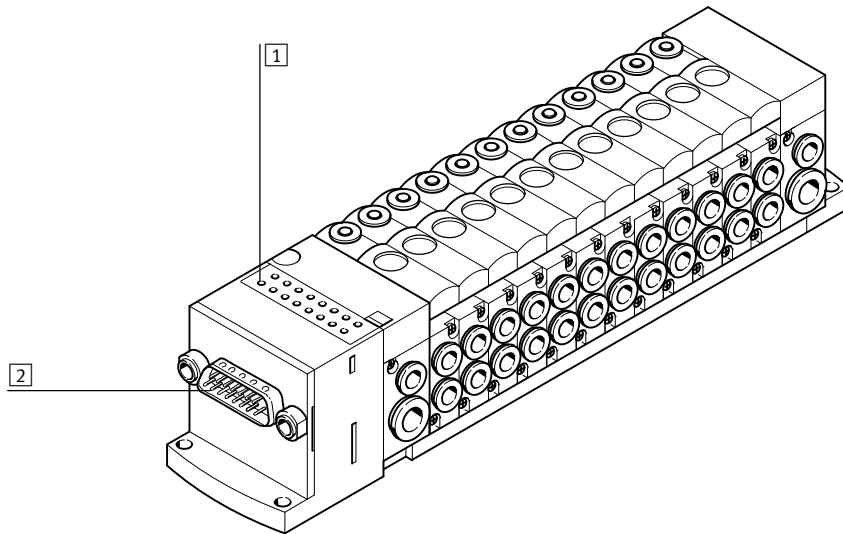

- 1 Status LEDs for valves
- 2 Connection Sub-D plug or flat cable

Inscription label holder

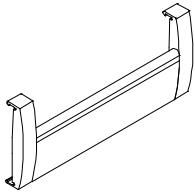

The transparent inscription label holder provides sufficient space for individually created labels on paper or foil.

Labelling templates are available on
→ www.festo.com

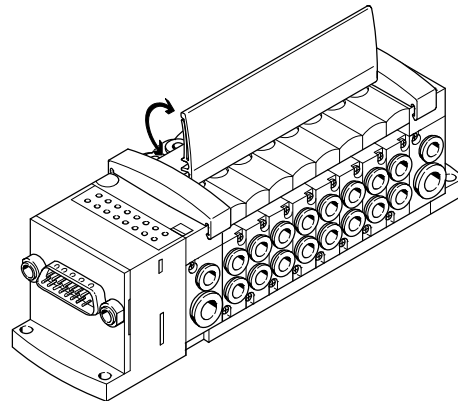

Valve terminals CPV-SC, Smart Cubic

Key features – Mounting types

Mounting – Valve terminal

Sturdy terminal mounting thanks to:

- Four through-holes for wall mounting
- H-rail mounting

Wall mounting

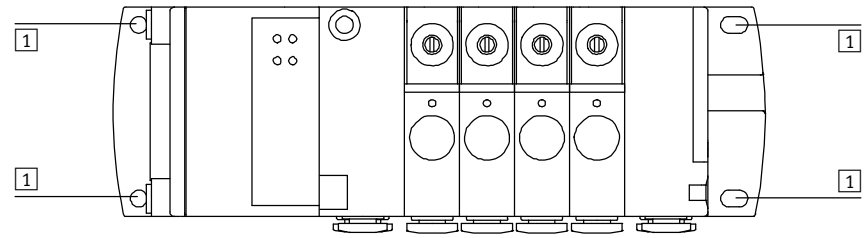

1 Mounting holes for screws M3

H-rail mounting

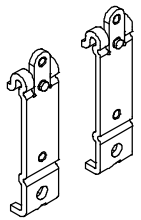

The mounting CPVSC1-HS35 facilitates mounting on a H-rail to EN 60715.

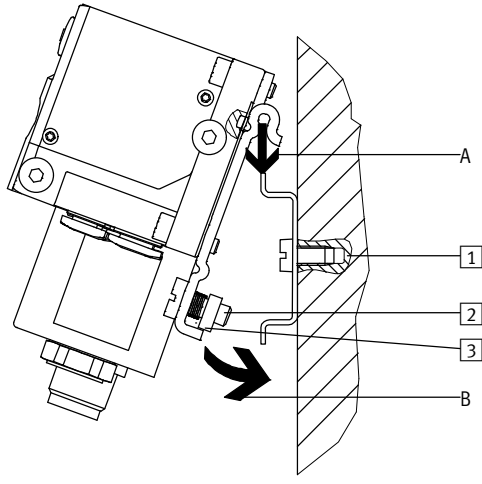



The CPV-SC valve terminal is attached to the H-rail (see arrow A). The valve terminal is then swivelled on the H-rail and secured in place with the clamping component (see arrow B).

- 1 Holes for wall mounting
- 2 Self-tapping M4x10 screw of the H-rail clamping unit
- 3 Clamping component of the H-rail clamping unit

Valve terminals CPV-SC, Smart Cubic

FESTO

Technical data

-  Flow rate
170 l/min
-  Valve width
10 mm
-  Voltage
5, 12, 24 V DC



General technical data					
Valve	5/2-way valve		3/2-way valve		2/2-way valve
	Single solenoid	Double solenoid	Normally open	Normally closed	Normally closed
Valve function order code	M	J	N	K	D
Constructional design	Electromagnetically actuated piston spool valve				
Reset method	Pneumatic spring	–	Pneumatic spring	Pneumatic spring	Pneumatic spring
Valve size [mm]	10		10		10
Nominal diameter [mm]	2.5		2.5		2.5
Standard nominal flow rate [l/min]	170		170		150
Sealing principle	Soft				
Control type	Piloted				
Lubrication	Life-time lubrication				
Type of mounting	Wall mounting				
Mounting position	Any				
Manual override	Non-detenting/detenting/overed				
Exhaust function	No flow control				
Direction of flow	Non-reversible				
Pneumatic connections					
Supply	1	M7, QS-6			
Exhaust port	3/5	M7, QS-6, round silencer or integrated flat plate silencer			
Working ports	2/4	Depending on the connection type selected <ul style="list-style-type: none"> • M5 • QS-3 • QS-4 			
Pilot air port	12/14	M5, QS-4			
Pilot exhaust air port	82/84	M5, QS-4, round silencer or integrated flat plate silencer			

Valve terminals CPV-SC, Smart Cubic

Technical data

FESTO

Pilot pressure p2 as a function of operating pressure p1

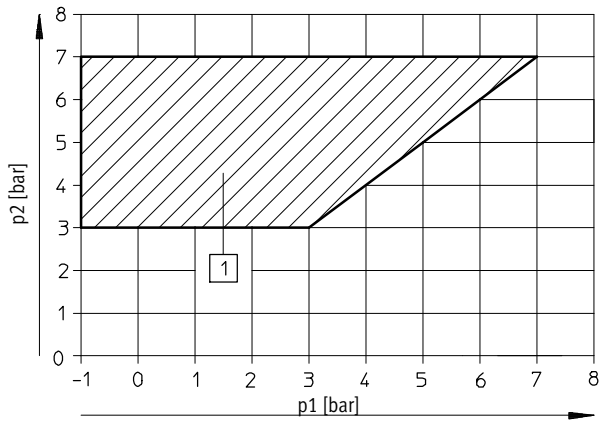

1 Operating range for valves with external pilot air

Valve response times [ms]

Valve function order code		M	J	N	K	D
Response times	on	10	–	10	10	10
	off	10	–	10	10	10
	changeover	–	8	–	–	–

Operating and environmental conditions

Operating medium	Compressed air in accordance with ISO 8573-1:2010 [7:4:4] → 24
Note on operating/pilot medium	Operation with lubricated medium possible (in which case lubricated operation will always be required)
Paint-wetting impairment substances criterion	Yes (free of paint-wetting impairment substances)
Certification	c UL us recognized (OL)
Operating pressure	bar] –0.9 ... +7
Operating pressure for valve terminal with internal pilot air supply	bar] 3 ... 7
Pilot pressure	bar] 3 ... 7
Ambient temperature	[°C] –5 ... +50
Temperature of medium	[°C] –5 ... +50
CE mark (see declaration of conformity)	To EU EMC Directive ¹⁾
KC mark	KC EMC
Note on materials	RoHS-compliant

1) For information about the applicability of the component see the manufacturer's EC declaration of conformity at: www.festo.com/sp → Certificates.
If the component is subject to restrictions on usage in residential, office or commercial environments or small businesses, further measures to reduce the emitted interference may be necessary.

Valve terminals CPV-SC, Smart Cubic

Technical data

Electrical data			
Electrical connection		Individual connection	
		Multi-pin	
Electromagnetic compatibility of the CPV-SC valve terminal with Sub-D or flat cable connection		Interference emission tested to DIN EN 61000-6-4, industry	
		Interference immunity ¹⁾ tested to DIN EN 61000-6-2, industry	
Protection against electric shock (protection against direct and indirect contact to EN 60204-1/IEC 204)		By means of PELV power supply unit	
Nominal operating voltage of valve terminal	Multi-pin plug connection	[V DC]	24
	Individual sub-base	[V]	5, 12, 24
Permissible voltage fluctuations		[%]	±10
Coil characteristics	Nominal voltage	[V DC]	5, 12, 22, 24
	Electrical power consumption	[W]	1
Duty cycle		100% at 40°C ambient temperature	
Protection class to EN 60529		IP40 (in assembled state and with detenting plug)	
Relative air humidity		[%]	90 at 40 °C, non-condensing

1) The maximum signal line length is 10 m

Materials	
Electrical interface	Polymer
End plate, electrical sub-base	Polymer
Seals	NBR
Valve slice	Die-cast aluminium
Sub-base for working ports	PA

Product weight [g]	
5/2-way, 3/2-way valve	30.5
5/2-way double solenoid valve	56.5
Blanking plate	22.5
Right-hand end plate	42.5
Left-hand end plate	28
Actuator housing	43
Tie rod, 16-fold	29.6
Electrical manifold module, 16-fold	64

Valve terminals CPV-SC, Smart Cubic

Technical data

FESTO

Equipment

Operate your equipment with unlubricated compressed air if possible.

Festo valves and cylinders are designed so that, if used as designated, they will not require additional lubrication and will still achieve a long service life.

The quality of compressed air downstream from the compressor must correspond to that of unlubricated compressed air. If possible, do not operate all of your equipment with lubricated compressed air. The lubricators should, where possible, always be installed directly upstream of the cylinders used.

Incorrect additional oil and too high an oil content in the compressed air reduces the service life of a valve terminal.

Use Festo special oil OFSW-32 or the alternatives listed in the Festo catalogue (as specified in DIN 51524 HLP32; basic oil viscosity 32 CST at 40°C).

Bio-oils

When using bio-oils (oils which are based upon synthetic or native ester, e.g. rapeseed oil methyl ester), the maximum residual oil content of 0.1 mg/m³ must not be exceeded (see ISO 8573-1 Class 2).

Mineral oils

When using mineral oils (e.g. HLP oils to DIN 51524, Parts 1 to 3) or similar oils based on poly-alpha-olefins (PAO), the maximum residual oil content of 5 mg/m³ must not be exceeded (see ISO 8573-1 Class 4).

A higher residual oil content irrespective of the compressor oil cannot be permitted, as the basic lubricant would be flushed out over time.

Valve terminals CPV-SC, Smart Cubic

Technical data

Dimensions

Download CAD data → www.festo.com

With individual connection

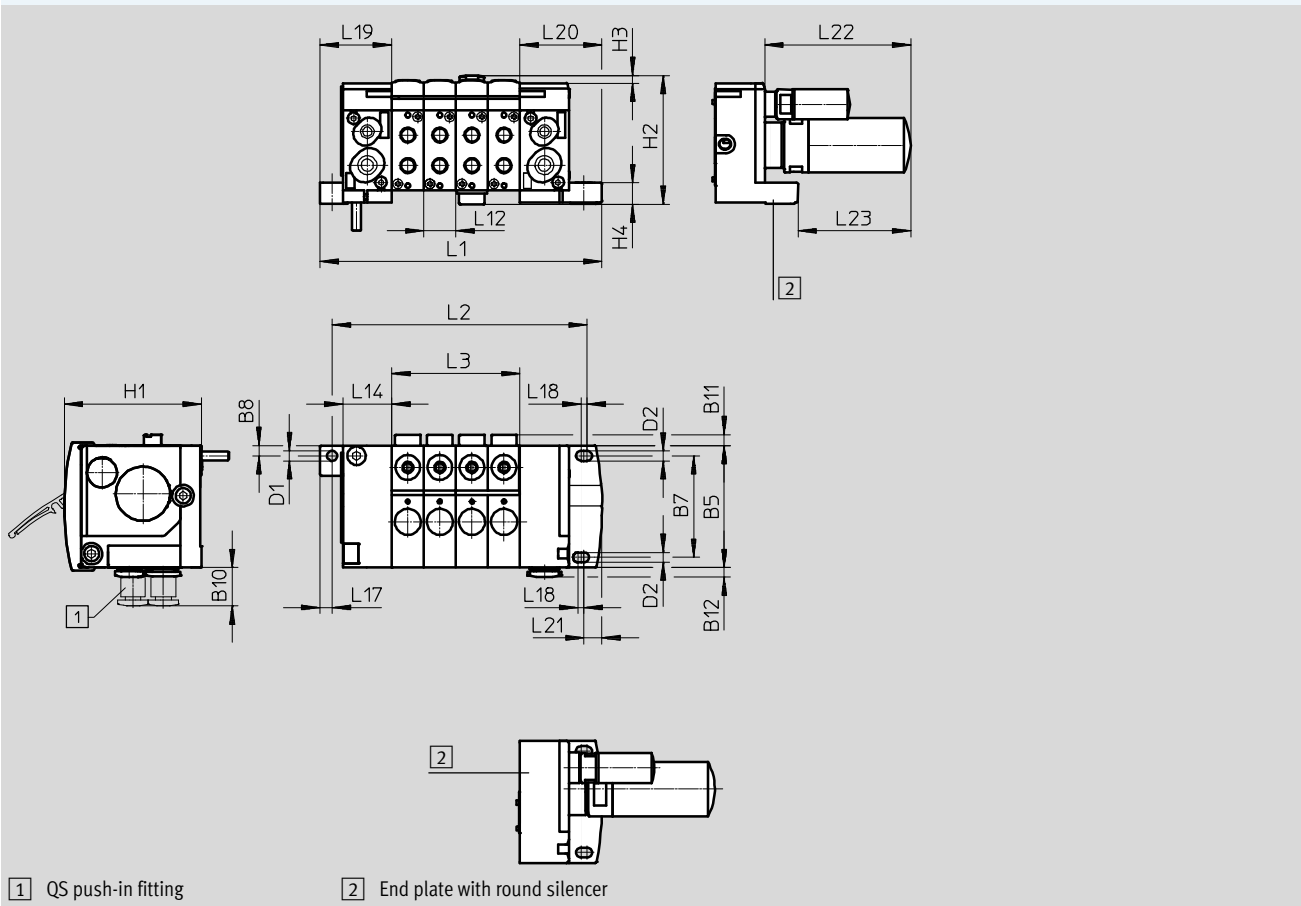

Type	B5	B7	B8	B10	B11	B12	D1 Ø	D2 Ø
With individual connection	40	33.2	3.4	10.5	3.6	3.1	3.3	3.2

Type	H1	H2	H3	H4	L12	L14	L17	L18	L19	L20	L21	L22	L23
With individual connection	45	42.2	2.6	6.9	10.5	16	4	2	23.5	26.9	4.9	48	37

Valve positions n	L1	L2	L3
2	71.4	62.5	21
3	81.9	73	31.5
4	92.4	83.5	42
5	102.9	94	52.5
6	113.4	104.5	63
7	123.9	115	73.5
8	134	125.1	84
9	144.9	136	94.5
10	155.4	146.5	105
11	165.9	157	115.5
12	176.4	167.5	126
13	186.9	178	136.5
14	197.4	188.5	147
15	207.9	199	157.5
16	218.4	209.5	168

Valve terminals CPV-SC, Smart Cubic

Technical data

FESTO

Dimensions

Download CAD data → www.festo.com

With multi-pin plug connection

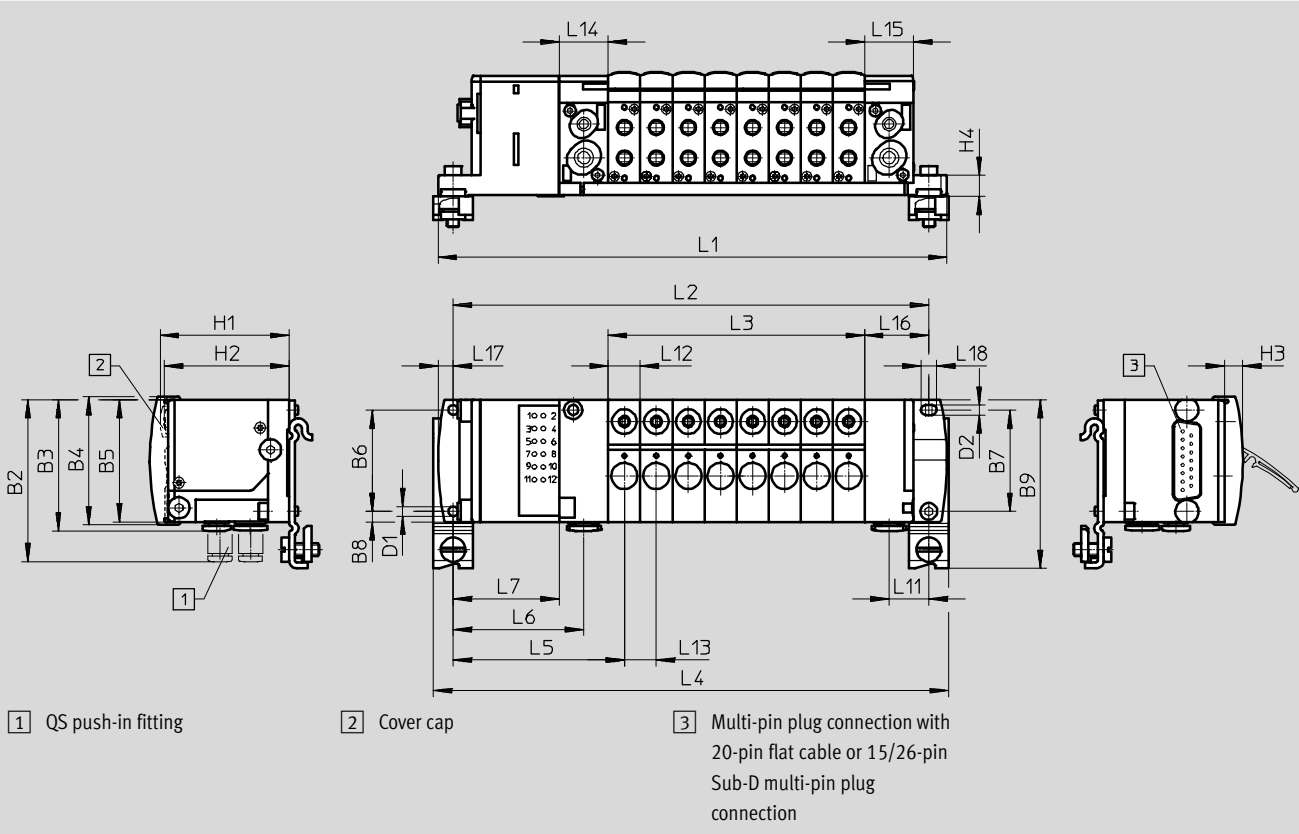

Type	B2	B3	B4	B5	B6	B7	B8	B9	D1 Ø	D2 Ø
With multi-pin plug connection	53.5	43.5	42	40	33.2	33.2	3.4	55.3	3.2	3.2

Type	H1	H2	H3	H4	L5	L6	L7	L11	L12	L13	L14	L15	L16	L17	L18
With multi-pin plug connection	43.4	42.1	6	6.9	56.1	42.8	34.8	13	10.5	10.5	16	16	21	4.9	5.2

Valve positions n	L1	L2	L3
4	125	114	42
5	135.5	124.5	52.5
6	146	135	63
7	146.5	145.5	73.5
8	167	156	84
9	177.5	166.5	94.5
10	188	177	105
11	198.5	187.5	115.5
12	209	198	126
13	219.5	208.5	136.5
14	230	219	147
15	240.5	229.5	157.5
16	251	240	168

Valve terminals CPV-SC, Smart Cubic

Technical data

Dimensions – Sub-D plug with cable

Download CAD data → www.festo.com

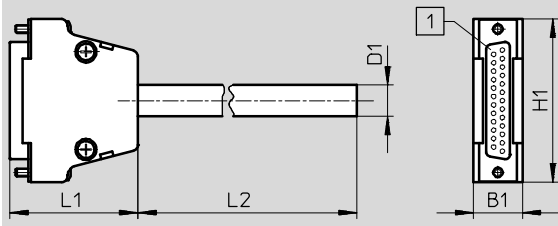

1 15-/26-pin plug

Type	B1	D1	H1	L1	L2			Number of pins
KMP6-15P-12-...	16	8.5	40	34.5	2,500	5,000	10,000	15
KMP6-26P-16-...	16	8.6	40	34.5	2,500	5,000	10,000	26

Valve terminals CPV-SC, Smart Cubic

Accessories

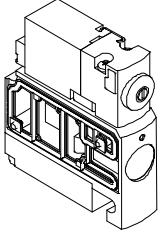
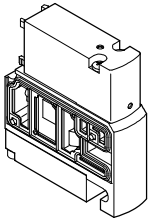
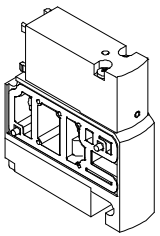
Ordering data – Valves with electrical plug-in connection			
	Valve function	Part no.	Type
	Solenoid valve with M5 connections		
	5/2-way valve, single solenoid	527550	CPVSC1-M1H-M-P-M5
	5/2-way valve, double solenoid	527553	CPVSC1-M1H-J-P-M5
	3/2-way valve, normally open	527551	CPVSC1-M1H-N-P-M50
	3/2-way valve, normally closed	527552	CPVSC1-M1H-K-P-M5C
	2/2-way valve, normally closed	527554	CPVSC1-M1H-D-P-M5C
	Solenoid valve with QS-3 push-in connectors		
	5/2-way valve, single solenoid	527555	CPVSC1-M1H-M-P-Q3
	5/2-way valve, double solenoid	527558	CPVSC1-M1H-J-P-Q3
	3/2-way valve, normally open	527556	CPVSC1-M1H-N-P-Q30
	3/2-way valve, normally closed	527557	CPVSC1-M1H-K-P-Q3C
	2/2-way valve, normally closed	527559	CPVSC1-M1H-D-P-Q3C
	Solenoid valve with QS-4 push-in connectors		
	5/2-way valve, single solenoid	527560	CPVSC1-M1H-M-P-Q4
	5/2-way valve, double solenoid	527563	CPVSC1-M1H-J-P-Q4
3/2-way valve, normally open	527561	CPVSC1-M1H-N-P-Q40	
3/2-way valve, normally closed	527562	CPVSC1-M1H-K-P-Q4C	
2/2-way valve, normally closed	527564	CPVSC1-M1H-D-P-Q4C	
	Plates with integrated connections		
	Vacant position, with cover plate	527527	CPVSC1-RP-B
	Supply plate M5		
	Duct 1 separated	527528	CPVSC1-SP-P-M5
	Duct 1/3/5 separated	527530	CPVSC1-SP-PRS-M5
	Without duct separation	527532	CPVSC1-SP-M5
	Supply plate, QS-4 push-in connector		
	Duct 1 separated	527529	CPVSC1-SP-P-Q4
	Duct 1/3/5 separated	527531	CPVSC1-SP-PRS-Q4
	Without duct separation	527533	CPVSC1-SP-Q4

Valve terminals CPV-SC, Smart Cubic

Accessories

FESTO

Ordering data – Valves with individual electrical connection, detenting manual override, plug at top, 24 V DC

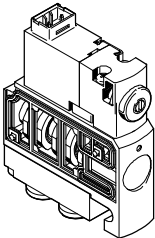
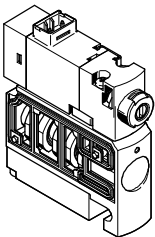
Designation	Part no.	Type
	Solenoid valve with M5 connections	
	5/2-way valve, single solenoid	547276 CPVSC1-M1H-M-T-M5
	5/2-way valve, double solenoid	547277 CPVSC1-M1H-J-T-M5
	3/2-way valve, normally open	547275 CPVSC1-M1H-N-T-M50
	3/2-way valve, normally closed	547274 CPVSC1-M1H-K-T-M5C
	2/2-way valve, normally closed	547273 CPVSC1-M1H-D-T-M5C
	Solenoid valve with M5 connections and LED	
	5/2-way valve, single solenoid	547306 CPVSC1-M1LH-M-T-M5
	5/2-way valve, double solenoid	547307 CPVSC1-M1LH-J-T-M5
	3/2-way valve, normally open	547305 CPVSC1-M1LH-N-T-M50
	3/2-way valve, normally closed	547304 CPVSC1-M1LH-K-T-M5C
	2/2-way valve, normally closed	547303 CPVSC1-M1LH-D-T-M5C
	Solenoid valve with QS-3 push-in connectors	
	5/2-way valve, single solenoid	547281 CPVSC1-M1H-M-T-Q3
	5/2-way valve, double solenoid	547282 CPVSC1-M1H-J-T-Q3
	3/2-way valve, normally open	547280 CPVSC1-M1H-N-T-Q30
	3/2-way valve, normally closed	547279 CPVSC1-M1H-K-T-Q3C
	2/2-way valve, normally closed	547278 CPVSC1-M1H-D-T-Q3C
	Solenoid valve with QS-3 push-in connectors and LED	
	5/2-way valve, single solenoid	547311 CPVSC1-M1LH-M-T-Q3
	5/2-way valve, double solenoid	547312 CPVSC1-M1LH-J-T-Q3
	3/2-way valve, normally open	547310 CPVSC1-M1LH-N-T-Q30
	3/2-way valve, normally closed	547309 CPVSC1-M1LH-K-T-Q3C
	2/2-way valve, normally closed	547308 CPVSC1-M1LH-D-T-Q3C
	Solenoid valve with QS-4 push-in connectors	
	5/2-way valve, single solenoid	547286 CPVSC1-M1H-M-T-Q4
	5/2-way valve, double solenoid	547287 CPVSC1-M1H-J-T-Q4
	3/2-way valve, normally open	547285 CPVSC1-M1H-N-T-Q40
	3/2-way valve, normally closed	547284 CPVSC1-M1H-K-T-Q4C
	2/2-way valve, normally closed	547283 CPVSC1-M1H-D-T-Q4C
	Solenoid valve with QS-4 push-in connectors and LED	
	5/2-way valve, single solenoid	547316 CPVSC1-M1LH-M-T-Q4
	5/2-way valve, double solenoid	547317 CPVSC1-M1LH-J-T-Q4
	3/2-way valve, normally open	547315 CPVSC1-M1LH-N-T-Q40
	3/2-way valve, normally closed	547314 CPVSC1-M1LH-K-T-Q4C
	2/2-way valve, normally closed	547313 CPVSC1-M1LH-D-T-Q4C

Valve terminals CPV-SC, Smart Cubic

Accessories

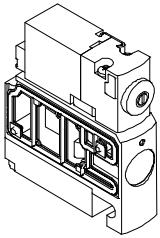
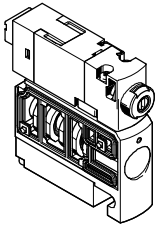
Ordering data – Valves with individual electrical connection, detenting manual override, plug at rear, 24 V DC		
Designation	Part no.	Type
	Solenoid valve with M5 connections	
	5/2-way valve, single solenoid	547291 CPVSC1-M1H-M-H-M5
	5/2-way valve, double solenoid	547292 CPVSC1-M1H-J-H-M5
	3/2-way valve, normally open	547290 CPVSC1-M1H-N-H-M50
	3/2-way valve, normally closed	547289 CPVSC1-M1H-K-H-M5C
	2/2-way valve, normally closed	547288 CPVSC1-M1H-D-H-M5C
	Solenoid valve with M5 connections and LED	
	5/2-way valve, single solenoid	547322 CPVSC1-M1LH-M-H-M5
	5/2-way valve, double solenoid	547323 CPVSC1-M1LH-J-H-M5
	3/2-way valve, normally open	547321 CPVSC1-M1LH-N-H-M50
	3/2-way valve, normally closed	547320 CPVSC1-M1LH-K-H-M5C
	2/2-way valve, normally closed	547318 CPVSC1-M1LH-D-H-M5C
	Solenoid valve with QS-3 push-in connectors	
	5/2-way valve, single solenoid	547296 CPVSC1-M1H-M-H-Q3
	5/2-way valve, double solenoid	547297 CPVSC1-M1H-J-H-Q3
	3/2-way valve, normally open	547295 CPVSC1-M1H-N-H-Q30
	3/2-way valve, normally closed	547294 CPVSC1-M1H-K-H-Q3C
	2/2-way valve, normally closed	547293 CPVSC1-M1H-D-H-Q3C
	Solenoid valve with QS-3 push-in connectors and LED	
	5/2-way valve, single solenoid	547327 CPVSC1-M1LH-M-H-Q3
5/2-way valve, double solenoid	547328 CPVSC1-M1LH-J-H-Q3	
3/2-way valve, normally open	547326 CPVSC1-M1LH-N-H-Q30	
3/2-way valve, normally closed	547325 CPVSC1-M1LH-K-H-Q3C	
2/2-way valve, normally closed	547324 CPVSC1-M1LH-D-H-Q3C	
Solenoid valve with QS-4 push-in connectors		
5/2-way valve, single solenoid	547301 CPVSC1-M1H-M-H-Q4	
5/2-way valve, double solenoid	547302 CPVSC1-M1H-J-H-Q4	
3/2-way valve, normally open	547300 CPVSC1-M1H-N-H-Q40	
3/2-way valve, normally closed	547299 CPVSC1-M1H-K-H-Q4C	
2/2-way valve, normally closed	547298 CPVSC1-M1H-D-H-Q4C	
Solenoid valve with QS-4 push-in connectors and LED		
5/2-way valve, single solenoid	547332 CPVSC1-M1LH-M-H-Q4	
5/2-way valve, double solenoid	547333 CPVSC1-M1LH-J-H-Q4	
3/2-way valve, normally open	547331 CPVSC1-M1LH-N-H-Q40	
3/2-way valve, normally closed	547330 CPVSC1-M1LH-K-H-Q4C	
2/2-way valve, normally closed	547329 CPVSC1-M1LH-D-H-Q4C	

Valve terminals CPV-SC, Smart Cubic

Accessories

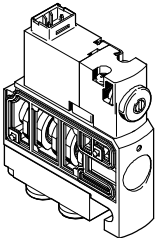
Ordering data – Valves with individual electrical connection, non-detenting manual override, plug at top, 24 V DC			
Designation		Part no.	Type
	Solenoid valve with M5 connections		
	5/2-way valve, single solenoid	548037	CPVSC1-M1HT-M-T-M5
	5/2-way valve, double solenoid	548038	CPVSC1-M1HT-J-T-M5
	3/2-way valve, normally open	548036	CPVSC1-M1HT-N-T-M50
	3/2-way valve, normally closed	548035	CPVSC1-M1HT-K-T-M5C
	2/2-way valve, normally closed	548034	CPVSC1-M1HT-D-T-M5C
	Solenoid valve with QS-3 push-in connectors		
	5/2-way valve, single solenoid	548043	CPVSC1-M1HT-M-T-Q3
	5/2-way valve, double solenoid	548044	CPVSC1-M1HT-J-T-Q3
	3/2-way valve, normally open	548042	CPVSC1-M1HT-N-T-Q30
	3/2-way valve, normally closed	548041	CPVSC1-M1HT-K-T-Q3C
	2/2-way valve, normally closed	548040	CPVSC1-M1HT-D-T-Q3C
	Solenoid valve with QS-4 push-in connectors		
	5/2-way valve, single solenoid	548048	CPVSC1-M1HT-M-T-Q4
	5/2-way valve, double solenoid	548049	CPVSC1-M1HT-J-T-Q4
3/2-way valve, normally open	548047	CPVSC1-M1HT-N-T-Q40	
3/2-way valve, normally closed	548046	CPVSC1-M1HT-K-T-Q4C	
2/2-way valve, normally closed	548045	CPVSC1-M1HT-D-T-Q4C	

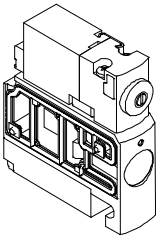
Ordering data – Valves with individual electrical connection, non-detenting manual override, plug connector at rear, 24 V DC			
Designation		Part no.	Type
	Solenoid valve with M5 connections		
	5/2-way valve, single solenoid	548053	CPVSC1-M1HT-M-H-M5
	5/2-way valve, double solenoid	548054	CPVSC1-M1HT-J-H-M5
	3/2-way valve, normally open	548052	CPVSC1-M1HT-N-H-M50
	3/2-way valve, normally closed	548051	CPVSC1-M1HT-K-H-M5C
	2/2-way valve, normally closed	548050	CPVSC1-M1HT-D-H-M5C
	Solenoid valve with QS-3 push-in connectors		
	5/2-way valve, single solenoid	548058	CPVSC1-M1HT-M-H-Q3
	5/2-way valve, double solenoid	548059	CPVSC1-M1HT-J-H-Q3
	3/2-way valve, normally open	548057	CPVSC1-M1HT-N-H-Q30
	3/2-way valve, normally closed	548056	CPVSC1-M1HT-K-H-Q3C
	2/2-way valve, normally closed	548055	CPVSC1-M1HT-D-H-Q3C
	Solenoid valve with QS-4 push-in connectors		
	5/2-way valve, single solenoid	548063	CPVSC1-M1HT-M-H-Q4
	5/2-way valve, double solenoid	548064	CPVSC1-M1HT-J-H-Q4
3/2-way valve, normally open	548062	CPVSC1-M1HT-N-H-Q40	
3/2-way valve, normally closed	548061	CPVSC1-M1HT-K-H-Q4C	
2/2-way valve, normally closed	548060	CPVSC1-M1HT-D-H-Q4C	

Valve terminals CPV-SC, Smart Cubic

Accessories

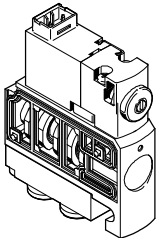
Ordering data – Valves with individual electrical connection, detenting manual override, plug at top, 12 V DC			
Designation		Part no.	Type
	Solenoid valve with M5 connections		
	5/2-way valve, single solenoid	547367	CPVSC1-M5H-M-T-M5
	5/2-way valve, double solenoid	547368	CPVSC1-M5H-J-T-M5
	3/2-way valve, normally open	547366	CPVSC1-M5H-N-T-M50
	3/2-way valve, normally closed	547365	CPVSC1-M5H-K-T-M5C
	2/2-way valve, normally closed	547364	CPVSC1-M5H-D-T-M5C
	Solenoid valve with QS-3 push-in connectors		
	5/2-way valve, single solenoid	547372	CPVSC1-M5H-M-T-Q3
	5/2-way valve, double solenoid	547373	CPVSC1-M5H-J-T-Q3
	3/2-way valve, normally open	547371	CPVSC1-M5H-N-T-Q30
	3/2-way valve, normally closed	547370	CPVSC1-M5H-K-T-Q3C
	2/2-way valve, normally closed	547369	CPVSC1-M5H-D-T-Q3C
	Solenoid valve with QS-4 push-in connectors		
	5/2-way valve, single solenoid	547377	CPVSC1-M5H-M-T-Q4
	5/2-way valve, double solenoid	547378	CPVSC1-M5H-J-T-Q4
3/2-way valve, normally open	547376	CPVSC1-M5H-N-T-Q40	
3/2-way valve, normally closed	547375	CPVSC1-M5H-K-T-Q4C	
2/2-way valve, normally closed	547374	CPVSC1-M5H-D-T-Q4C	

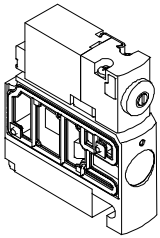
Ordering data – Valves with individual electrical connection, non-detenting manual override, plug at rear, 12 V DC			
Designation		Part no.	Type
	Solenoid valve with M5 connections		
	5/2-way valve, single solenoid	547382	CPVSC1-M5H-M-H-M5
	5/2-way valve, double solenoid	547383	CPVSC1-M5H-J-H-M5
	3/2-way valve, normally open	547381	CPVSC1-M5H-N-H-M50
	3/2-way valve, normally closed	547380	CPVSC1-M5H-K-H-M5C
	2/2-way valve, normally closed	547379	CPVSC1-M5H-D-H-M5C
	Solenoid valve with QS-3 push-in connectors		
	5/2-way valve, single solenoid	547387	CPVSC1-M5H-M-H-Q3
	5/2-way valve, double solenoid	547388	CPVSC1-M5H-J-H-Q3
	3/2-way valve, normally open	547386	CPVSC1-M5H-N-H-Q30
	3/2-way valve, normally closed	547385	CPVSC1-M5H-K-H-Q3C
	2/2-way valve, normally closed	547384	CPVSC1-M5H-D-H-Q3C
	Solenoid valve with QS-4 push-in connectors		
	5/2-way valve, single solenoid	547392	CPVSC1-M5H-M-H-Q4
	5/2-way valve, double solenoid	547393	CPVSC1-M5H-J-H-Q4
3/2-way valve, normally open	547391	CPVSC1-M5H-N-H-Q40	
3/2-way valve, normally closed	547390	CPVSC1-M5H-K-H-Q4C	
2/2-way valve, normally closed	547389	CPVSC1-M5H-D-H-Q4C	

Valve terminals CPV-SC, Smart Cubic

Accessories

FESTO

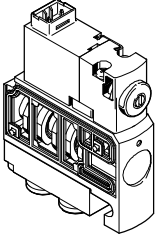
Ordering data – Valves with individual electrical connection, detenting manual override, plug on top, 5 V DC			
Designation		Part no.	Type
	Solenoid valve with M5 connections		
	5/2-way valve, single solenoid	547337	CPVSC1-M4H-M-T-M5
	5/2-way valve, double solenoid	547338	CPVSC1-M4H-J-T-M5
	3/2-way valve, normally open	547336	CPVSC1-M4H-N-T-M5O
	3/2-way valve, normally closed	547335	CPVSC1-M4H-K-T-M5C
	2/2-way valve, normally closed	547334	CPVSC1-M4H-D-T-M5C
	Solenoid valve with QS-3 push-in connectors		
	5/2-way valve, single solenoid	547342	CPVSC1-M4H-M-T-Q3
	5/2-way valve, double solenoid	547343	CPVSC1-M4H-J-T-Q3
	3/2-way valve, normally open	547341	CPVSC1-M4H-N-T-Q3O
	3/2-way valve, normally closed	547340	CPVSC1-M4H-K-T-Q3C
	2/2-way valve, normally closed	547339	CPVSC1-M4H-D-T-Q3C
	Solenoid valve with QS-4 push-in connectors		
	5/2-way valve, single solenoid	547347	CPVSC1-M4H-M-T-Q4
	5/2-way valve, double solenoid	547348	CPVSC1-M4H-J-T-Q4
3/2-way valve, normally open	547346	CPVSC1-M4H-N-T-Q4O	
3/2-way valve, normally closed	547345	CPVSC1-M4H-K-T-Q4C	
2/2-way valve, normally closed	547344	CPVSC1-M4H-D-T-Q4C	

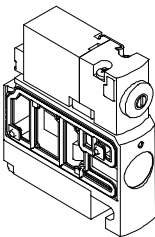



Ordering data – Valves with individual electrical connection, non-detenting manual override, plug at rear, 5 V DC			
Designation		Part no.	Type
	Solenoid valve with M5 connections		
	5/2-way valve, single solenoid	547352	CPVSC1-M4H-M-H-M5
	5/2-way valve, double solenoid	547353	CPVSC1-M4H-J-H-M5
	3/2-way valve, normally open	547351	CPVSC1-M4H-N-H-M5O
	3/2-way valve, normally closed	547350	CPVSC1-M4H-K-H-M5C
	2/2-way valve, normally closed	547349	CPVSC1-M4H-D-H-M5C
	Solenoid valve with QS-3 push-in connectors		
	5/2-way valve, single solenoid	547357	CPVSC1-M4H-M-H-Q3
	5/2-way valve, double solenoid	547358	CPVSC1-M4H-J-H-Q3
	3/2-way valve, normally open	547356	CPVSC1-M4H-N-H-Q3O
	3/2-way valve, normally closed	547355	CPVSC1-M4H-K-H-Q3C
	2/2-way valve, normally closed	547354	CPVSC1-M4H-D-H-Q3C
	Solenoid valve with QS-4 push-in connectors		
	5/2-way valve, single solenoid	547362	CPVSC1-M4H-M-H-Q4
	5/2-way valve, double solenoid	547363	CPVSC1-M4H-J-H-Q4
3/2-way valve, normally open	547361	CPVSC1-M4H-N-H-Q4O	
3/2-way valve, normally closed	547360	CPVSC1-M4H-K-H-Q4C	
2/2-way valve, normally closed	547359	CPVSC1-M4H-D-H-Q4C	

Valve terminals CPV-SC, Smart Cubic

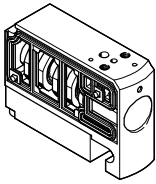
FESTO

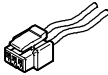
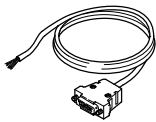
Accessories





Ordering data – Valves without pilot control			
Designation		Part no.	Type
	Valve with M5 connections		
	5/2-way valve, single solenoid	548901	CPVSC1-M-M5
	5/2-way valve, double solenoid	548902	CPVSC1-J-M5
	3/2-way valve, normally open	548900	CPVSC1-N-M50
	3/2-way valve, normally closed	548899	CPVSC1-K-M5C
	2/2-way valve, normally closed	548898	CPVSC1-D-M5C
	Valve with push-in connectors		
	5/2-way valve, single solenoid	548906	CPVSC1-M-QX
	5/2-way valve, double solenoid	548907	CPVSC1-J-QX
	3/2-way valve, normally open	548905	CPVSC1-N-QXO
	3/2-way valve, normally closed	548904	CPVSC1-K-QXC
	2/2-way valve, normally closed	548903	CPVSC1-D-QXC

Ordering data – Accessories			
Designation		Part no.	Type
Individual electrical connection			
	Plug socket with cable, IP40	0.5 m	566654 NEBV-H1G2-KN-0.5-N-LE2
		1 m	566655 NEBV-H1G2-KN-1-N-LE2
		2.5 m	566656 NEBV-H1G2-KN-2.5-N-LE2
		5 m	566657 NEBV-H1G2-KN-5-N-LE2
Connecting cable to IP40 for multi-pin plug connection			
	Sub-D, 15-pin, up to 12 valve positions for code MS Material: PVC	2.5 m	527543 KMP6-15P-12-2,5
		5 m	527544 KMP6-15P-12-5
		10 m	527545 KMP6-15P-12-10
	Sub-D, 26-pin, up to 16 valve positions for code MH Material: PVC	2.5 m	527546 KMP6-26P-16-2,5
		5 m	527547 KMP6-26P-16-5
		10 m	527548 KMP6-26P-16-10
Cover for manual override			
	Non-detenting, with coded cover cap	10 pieces	540897 VMPA-HBT-B
	Covered, manual override blocked	10 pieces	540898 VMPA-HBV-B
	Detenting, manually operated without accessories	10 pieces	8002234 VAMC-L1-CD
Inscription labels for valve identification			
	9x4.5 mm	80 pieces	197259 MH-BZ-80x

Valve terminals CPV-SC, Smart Cubic

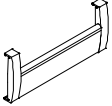
Accessories

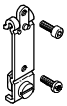
FESTO

Ordering data – Accessories				
Designation			Part no.	Type
Inscription label holder				
	1 piece	For 2 valve positions	547395	CPVSC1-ST-2
		For 3 valve positions	547396	CPVSC1-ST-3
		For 4 valve positions	527631	CPVSC1-ST-4
		For 5 valve positions	547397	CPVSC1-ST-5
		For 6 valve positions	547398	CPVSC1-ST-6
		For 7 valve positions	547399	CPVSC1-ST-7
		For 8 valve positions	527633	CPVSC1-ST-8
		For 9 valve positions	547400	CPVSC1-ST-9
		For 10 valve positions	547401	CPVSC1-ST-10
		For 11 valve positions	547402	CPVSC1-ST-11
		For 12 valve positions	527635	CPVSC1-ST-12
		For 13 valve positions	547403	CPVSC1-ST-13
		For 14 valve positions	547404	CPVSC1-ST-14
		For 15 valve positions	547405	CPVSC1-ST-15
		For 16 valve positions	527637	CPVSC1-ST-16
		Tie rod		
	1 piece	For 2 valve positions	547416	CPVSC1-ZA-2
		For 3 valve positions	547417	CPVSC1-ZA-3
		For 4 valve positions	532807	CPVSC1-ZA-4
		For 5 valve positions	547418	CPVSC1-ZA-5
		For 6 valve positions	547419	CPVSC1-ZA-6
		For 7 valve positions	547420	CPVSC1-ZA-7
		For 8 valve positions	532808	CPVSC1-ZA-8
		For 9 valve positions	547421	CPVSC1-ZA-9
		For 10 valve positions	547422	CPVSC1-ZA-10
		For 11 valve positions	547423	CPVSC1-ZA-11
		For 12 valve positions	532809	CPVSC1-ZA-12
		For 13 valve positions	547424	CPVSC1-ZA-13
		For 14 valve positions	547425	CPVSC1-ZA-14
		For 15 valve positions	547426	CPVSC1-ZA-15
		For 16 valve positions	532810	CPVSC1-ZA-16
		Mounting		
	Screw for additional terminal mounting		527643	M3x45
	Mounting		527639	CPVSC-HS35
User documentation				
	User documentation – Pneumatics, valve terminal CPV-SC	German	530925	P.BE-CPVSC-DE
		English	530926	P.BE-CPVSC-EN
		French	530927	P.BE-CPVSC-FR
		Spanish	530928	P.BE-CPVSC-ES
		Italian	530929	P.BE-CPVSC-IT