

Solenoid valves VZWD, directly actuated, NPT



Solenoid valves VZWD, directly actuated, NPT

Key features and overview

FESTO

General



Directly actuated solenoid valves VZWD are mainly intended for applications with high pressure ranges and low flow rates. This type of valve switches the sealing

element directly via the solenoid system. The seal generally has to lift away from the seat against the effective operating pressure using just the drive. A closing spring

keeps the valve closed assisted by the pressure of the medium. The function is dependent on the seat size, the effective operating

pressure and the magnetic force. The difference with force pilot operated solenoid valves (VZWF) lies in the flow rate.

General

-  - Connecting thread
1/4 NPT, 1/8 NPT
-  - Flow rate Kv
0.06 ... 0.4 m³/h

Areas of application

- Use in vacuum technology
- Venting gas and tank systems
- Safety shut-offs for burner controllers

Design

- Design insensitive to slight contamination of the media

Advantages

- Valves switch from 0 bar up to the max. operating pressure
- Excellent tightness

-  - Note

The valves are suitable for vacuum with Pabs > 100 mbar. Please ensure the direction of flow corresponds to the direction of the arrow.

Solenoid valves VZWD, directly actuated, NPT

Key features and overview

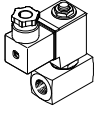
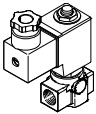
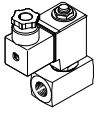
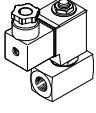
Version	Type	Process valve connection	Nominal size (DN)	Medium pressure ¹⁾ [bar]	→ Page/Internet
Brass housing					
	VZWD-L-...	1/4 NPT	1	0 ... 50	5
			1.5	0 ... 30	
			2	0 ... 15	
			2.5	0 ... 8	
		1/8 NPT	1	0 ... 50	5
			1.5	0 ... 30	
			2	0 ... 15	
Brass housing					
	VZWD-L-...	1/4 NPT	1	0 ... 90	8
			1.5	0 ... 85	
			2	0 ... 40	
			2.5	0 ... 22	
			3	0 ... 15	
			4	0 ... 8	
			5	0 ... 5	
			6	0 ... 4	
		1/8 NPT	1	0 ... 90	8
			1.5	0 ... 85	
			2	0 ... 40	
			2.5	0 ... 22	
			3	0 ... 15	
			4	0 ... 8	
Stainless steel housing					
	VZWD-L-...-R1	1/4 NPT	1	0 ... 90	13
			1.5	0 ... 85	
			2	0 ... 40	
			2.5	0 ... 22	
			3	0 ... 15	
			4	0 ... 8	
			5	0 ... 5	
			6	0 ... 4	
	VZWD-L-...-R1	1/8 NPT	1	0 ... 90	13
			1.5	0 ... 85	
			2	0 ... 40	
			2.5	0 ... 22	
			3	0 ... 15	
			4	0 ... 8	
			5	0 ... 5	
			6	0 ... 4	

1) The valves are suitable for vacuum with Pabs > 100 mbar. Please ensure the direction of flow corresponds to the direction of the arrow.

Solenoid valves VZWD, directly actuated, NPT

Type codes

VZWD - L - M22C - M - N18 - 15 - V - 2AP4 - 40 - R1

Type

VZWD	Solenoid valve, directly actuated
------	-----------------------------------

Type of directional control valve

L	In-line valve
---	---------------

Valve function

M22C	2/2-way valve, normally closed, mechanical reset
------	--

Reset method

M	Mechanical spring
---	-------------------

Process valve connection

N18	1/8 NPT
N14	1/4 NPT

Nominal size (DN)

10	1.0 mm
15	1.5 mm
20	2.0 mm
25	2.5 mm
30	3.0 mm
40	4.0 mm
50	5.0 mm
60	6.0 mm

Sealing material

V	FPM
---	-----

Nominal operating voltage

1	24 V DC
2A	110 V AC/50-60 Hz
3A	230 V AC/50-60 Hz

Electrical connection

P4	Plug socket, 3-pin
----	--------------------

Medium pressure

4	Max. 4 bar
5	Max. 5 bar
8	Max. 8 bar
15	Max. 15 bar
22	Max. 22 bar
30	Max. 30 bar
40	Max. 40 bar
50	Max. 50 bar
85	Max. 85 bar
90	Max. 90 bar

Corrosion protection

	Brass
R1	Stainless steel

Solenoid valves VZWD, directly actuated, NPT

Technical data – Brass housing, nominal pressure PN 50

Function

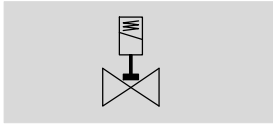

-  - Flow rate Kv
0.06 ... 0.16 m³/h

-  - Connecting thread
1/4 NPT, 1/8 NPT



General technical data		1.0	1.5	2.0	2.5
Nominal size (DN)		1.0	1.5	2.0	2.5
Valve function		2/2-way, single solenoid, closed			
Design		Directly actuated poppet valve			
Type of mounting		In-line installation			
Actuation type		Electric			
Reset method		Mechanical spring			
Direction of flow		Non-reversible			
Type of control		Direct			
Manual override		None			
Mounting position		Any			
Sealing principle		Soft			
Max. viscosity	[mm ² /s]	22			
Protection class		IP65			

Operating and environmental conditions		1.0	1.5	2.0	2.5
Nominal size (DN)		1.0	1.5	2.0	2.5
Standard nominal flow rate	[l/min]	60	95	140	170
Flow rate Kv	[m ³ /h]	0.06	0.09	0.13	0.16
Process valve nominal pressure (PN)		50			
Medium		Compressed air in accordance with ISO 8573-1:2010 [7:4:4]			
		Inert gases			
		Mineral oil			
		Neutral liquids			
		Water			
		Further media upon request			
Differential pressure	[bar]	0			
Ambient temperature	[°C]	-10 ... +35 °C			
Temperature of medium	[°C]	-10 ... +80 °C			
Leak rate to EN 12266-1		A			
Corrosion resistance class CRC ¹⁾		1			

1) Corrosion resistance class 1 according to Festo standard 940 070
Components subject to low corrosion stress. Transport and storage protection. Parts that do not have primarily decorative surface requirements, e.g. in internal areas that are not visible or behind covers.

Solenoid valves VZWD, directly actuated, NPT

FESTO

Technical data – Brass housing, nominal pressure PN 50

Electrical data		VZWD- ... 1	VZWD- ... 2A	VZWD- ... 3A
Electrical connection		Plug to EN 175301-803 type A, square design		
CE marking		–	73/23/EEC	73/23/EEC
Insulation class		H	F	F
Duty cycle	[%]	100		
Permissible voltage fluctuations	[%]	±10		
Coil characteristics	Direct current DC	[V]	24	–
	Alternating current AC	[V]	–	110
		[W]	6.8	–
	Pick-up power	[VA]	–	10.5
	Holding power	[VA]	–	8
		[Hz]	–	50, 60
	Switching time on	[ms]	25	
Switching time off	[ms]	10		

Materials		
Solenoid valves		Material number
1 Housing	High-alloy stainless steel	1.4305
	Brass	CW614N
2 Seals	FPM	
– Note on materials	Contains PWIS (paint-wetting impairment substances), RoHS-compliant	

Dimensions Download CAD data → www.festo.com/en/engineering

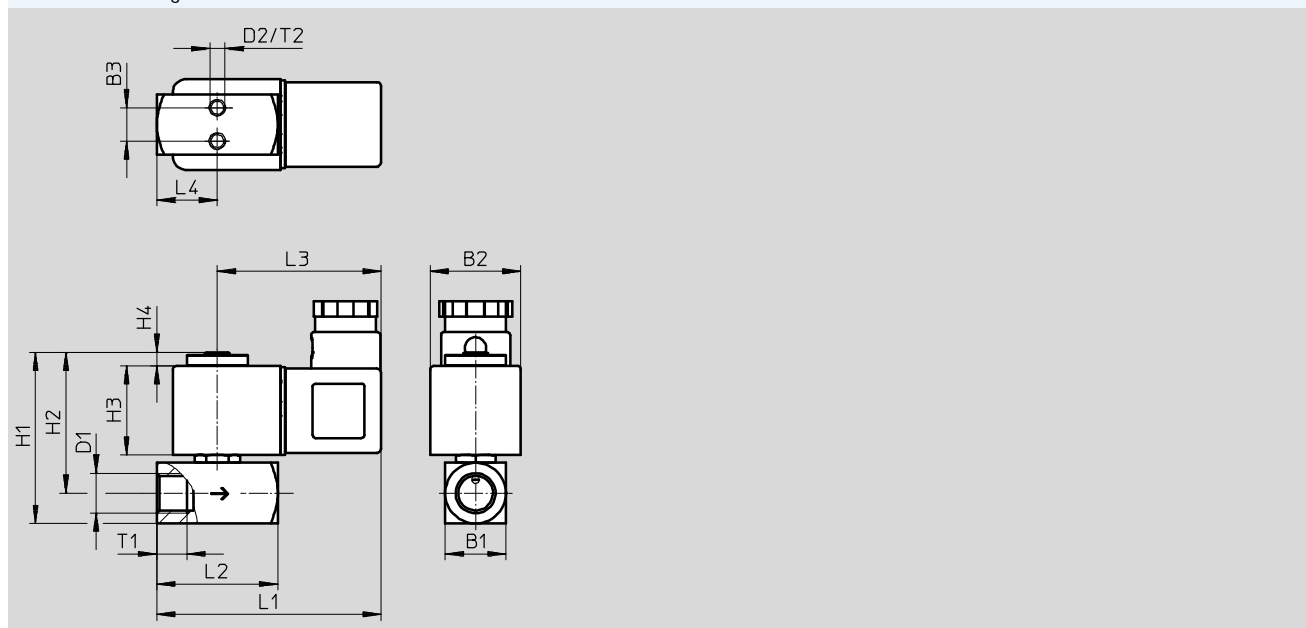

Type	B1	B2	B3	D1	D2	H1	H2	H3	H4	L1	L2	L3	L4	L5	T1	T2
VZWD-...-N1/8-10-...-50	15	30	8	1/8 NPT	M3	52	44	30	5	70	32	54	16	–	8	4.5
VZWD-...-N1/8-15-...-30																
VZWD-...-N1/8-20-...-15																
VZWD-...-N1/4-10-...-50	20	30	11	1/4 NPT	M5	57	47	30	5	74	40	54	20	–	10	5.5
VZWD-...-N1/4-15-...-30																
VZWD-...-N1/4-20-...-15																
VZWD-...-N1/4-25-...-8																

Solenoid valves VZWD, directly actuated, NPT

Technical data – Brass housing, nominal pressure PN 50

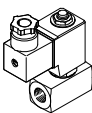
Ordering data						
	Process valve connection	Nominal size DN	Medium pressure ¹⁾ [bar]	Product weight [g]	Brass housing	
					Part No.	Type
	1/4 NPT	1	0 ... 50	350	1491945	VZWD-L-M22C-M-N14-10-V-2AP4-50
					1492023	VZWD-L-M22C-M-N14-10-V-3AP4-50
					1491867	VZWD-L-M22C-M-N14-10-V-1P4-50
		1.5	0 ... 30	350	1491946	VZWD-L-M22C-M-N14-15-V-2AP4-30
					1492024	VZWD-L-M22C-M-N14-15-V-3AP4-30
					1491868	VZWD-L-M22C-M-N14-15-V-1P4-30
		2	0 ... 15	350	1491947	VZWD-L-M22C-M-N14-20-V-2AP4-15
					1492025	VZWD-L-M22C-M-N14-20-V-3AP4-15
					1491869	VZWD-L-M22C-M-N14-20-V-1P4-15
		2.5	0 ... 8	350	1491948	VZWD-L-M22C-M-N14-25-V-2AP4-8
					1492026	VZWD-L-M22C-M-N14-25-V-3AP4-8
					1491870	VZWD-L-M22C-M-N14-25-V-1P4-8

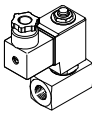
Ordering data						
	Process valve connection	Nominal size DN	Medium pressure ¹⁾ [bar]	Product weight [g]	Brass housing	
					Part No.	Type
	1/8 NPT	1	0 ... 50	300	1491942	VZWD-L-M22C-M-N18-10-V-2AP4-50
					1492020	VZWD-L-M22C-M-N18-10-V-3AP4-50
					1491864	VZWD-L-M22C-M-N18-10-V-1P4-50
		1.5	0 ... 30	300	1491943	VZWD-L-M22C-M-N18-15-V-2AP4-30
					1492021	VZWD-L-M22C-M-N18-15-V-3AP4-30
					1491865	VZWD-L-M22C-M-N18-15-V-1P4-30
		2	0 ... 15	300	1491944	VZWD-L-M22C-M-N18-20-V-2AP4-15
					1492022	VZWD-L-M22C-M-N18-20-V-3AP4-15
					1491866	VZWD-L-M22C-M-N18-20-V-1P4-15

1) The valves are suitable for vacuum with Pabs > 100 mbar. Please ensure the direction of flow corresponds to the direction of the arrow.

Solenoid valves VZWD, directly actuated, NPT

FESTO

Technical data – Brass housing, nominal pressure PN 100

Function

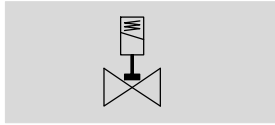

-  - Flow rate Kv
0.06 ... 0.4 m³/h

Nominal size (DN)
1.0 ... 6.0 mm

-  - Connecting thread
1/4 NPT, 1/8 NPT



General technical data								
Nominal size (DN)	1.0	1.5	2.0	2.5	3.0	4.0	5.0	6.0
Valve function	2/2-way, single solenoid, closed							
Design	Directly actuated poppet valve							
Type of mounting	In-line installation							
Actuation type	Electric							
Reset method	Mechanical spring							
Direction of flow	Non-reversible							
Type of control	Direct							
Manual override	None							
Mounting position	Any							
Sealing principle	Soft							
Max. viscosity [mm ² /s]	22							
Protection class	IP65							

Operating and environmental conditions								
Nominal size (DN)	1.0	1.5	2.0	2.5	3.0	4.0	5.0	6.0
Standard nominal flow rate [l/min]	60	95	140	170	210	310	375	430
Flow rate Kv [m ³ /h]	0.06	0.09	0.13	0.16	0.2	0.3	0.35	0.4
Process valve nominal pressure (PN)	100							
Differential pressure [bar]	0							
Medium	Compressed air in accordance with ISO 8573-1:2010 [7:4:4]							
	Inert gases							
	Mineral oil							
	Neutral liquids							
	Water							
	Further media upon request							
Ambient temperature [°C]	-10 ... +35 °C							
Temperature of medium [°C]	-10 ... +80 °C							
Leak rate to EN 12266-1	A							
Corrosion resistance class CRC ¹⁾	1							

1) Corrosion resistance class 1 according to Festo standard 940 070
Components subject to low corrosion stress. Transport and storage protection. Parts that do not have primarily decorative surface requirements, e.g. in internal areas that are not visible or behind covers.

Solenoid valves VZWD, directly actuated, NPT



Technical data – Brass housing, nominal pressure PN 100

Electrical data				
		VZWD- ... 1	VZWD- ... 2A	VZWD- ... 3A
Electrical connection		Plug to EN 175301-803 type A, square design		
CE marking		–	73/23/EEC	73/23/EEC
Insulation class		H	F	F
Duty cycle	[%]	100		
Permissible voltage fluctuations	[%]	±10		
Coil characteristics	Direct current DC	[V]	24	–
	Alternating current AC	[V]	–	110
		[W]	11	–
	Pick-up power	[VA]	–	19
	Holding power	[VA]	–	16
		[Hz]	–	50, 60
	Switching time on	[ms]	20	
Switching time off	[ms]	18		

Materials		
Solenoid valves		Material number
1 Housing	High-alloy stainless steel	1.4305
	Brass	CW614N
2 Seals	FPM	
– Note on materials	Contains PWIS (paint-wetting impairment substances), RoHS-compliant	

Solenoid valves VZWD, directly actuated, NPT

Technical data – Brass housing, nominal pressure PN 100



Dimensions

Download CAD data → www.festo.com/en/engineering

Die-cast brass housing

Milled brass housing

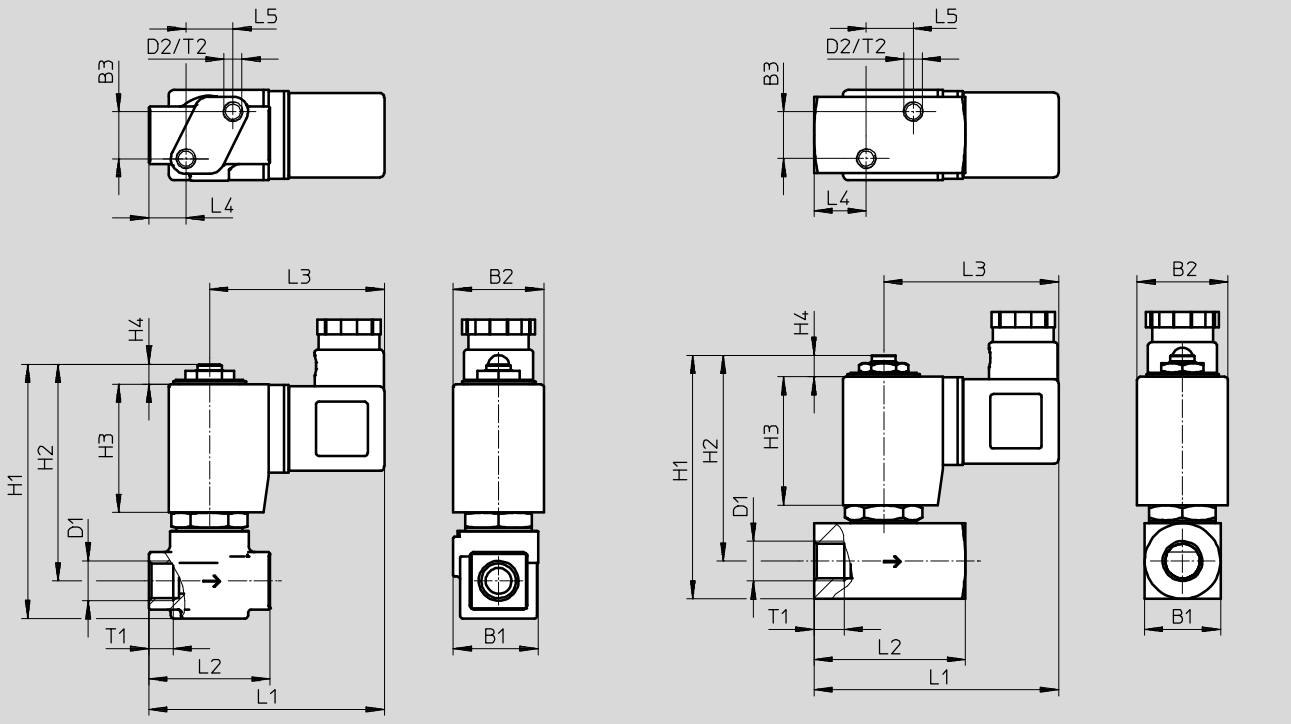

Type	B1	B2	B3	D1	D2	H1	H2	H3	H4	L1	L2	L3	L4	L5	T1	T2
VZWD-...-N1/8-10-...-90	28	30	15.5	1/8 NPT	M6	84	72	42.5	6.5	78	40	58	12	15.5	8	6
VZWD-...-N1/8-15-...-85																
VZWD-...-N1/8-20-...-40																
VZWD-...-N1/8-25-...-22																
VZWD-...-N1/8-30-...-15																
VZWD-...-N1/8-40-...-8	28	30	15.5	1/4 NPT	M6	84	72	42.5	6.5	78	40	58	12	15.5	10	6
VZWD-...-N1/4-10-...-90																
VZWD-...-N1/4-15-...-85																
VZWD-...-N1/4-20-...-40																
VZWD-...-N1/4-30-...-15																
VZWD-...-N1/4-40-...-8	25	30	15.5	1/8 NPT	M6	81	68	42.5	7	78	40	58	12	15.5	8	6
VZWD-...-N1/8-50-...-5																
VZWD-...-N1/8-60-...-4																
VZWD-...-N1/4-50-...-5	25	30	15.5	1/4 NPT	M6	81	68	42.5	7	85	50	58	17	15.5	10	6
VZWD-...-N1/4-60-...-4																

Solenoid valves VZWD, directly actuated, NPT

Technical data – Brass housing, nominal pressure PN 100

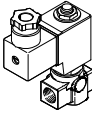
Ordering data						
	Process valve connection	Nominal size DN	Medium pressure ¹⁾ [bar]	Product weight [g]	Brass housing	
					Part No.	Type
	1/4 NPT	1	0 ... 90	550	1491957	VZWD-L-M22C-M-N14-10-V-2AP4-90
					1492040	VZWD-L-M22C-M-N14-10-V-3AP4-90
					1491879	VZWD-L-M22C-M-N14-10-V-1P4-90
		1.5	0 ... 85	550	1491958	VZWD-L-M22C-M-N14-15-V-2AP4-85
					1492041	VZWD-L-M22C-M-N14-15-V-3AP4-85
					1491880	VZWD-L-M22C-M-N14-15-V-1P4-85
		2	0 ... 40	550	1491959	VZWD-L-M22C-M-N14-20-V-2AP4-40
					1492042	VZWD-L-M22C-M-N14-20-V-3AP4-40
					1491881	VZWD-L-M22C-M-N14-20-V-1P4-40
		2.5	0 ... 22	550	1491960	VZWD-L-M22C-M-N14-25-V-2AP4-22
					1492043	VZWD-L-M22C-M-N14-25-V-3AP4-22
					1491882	VZWD-L-M22C-M-N14-25-V-1P4-22
		3	0 ... 15	550	1491961	VZWD-L-M22C-M-N14-30-V-2AP4-15
					1492044	VZWD-L-M22C-M-N14-30-V-3AP4-15
					1491883	VZWD-L-M22C-M-N14-30-V-1P4-15
		4	0 ... 8	550	1491962	VZWD-L-M22C-M-N14-40-V-2AP4-8
					1492045	VZWD-L-M22C-M-N14-40-V-3AP4-8
					1491884	VZWD-L-M22C-M-N14-40-V-1P4-8

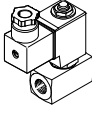
Ordering data						
	Process valve connection	Nominal size DN	Medium pressure ¹⁾ [bar]	Product weight [g]	Brass housing	
					Part No.	Type
	1/4 NPT	5	0 ... 5	600	1491885	VZWD-L-M22C-M-N14-50-V-1P4-5
					1491963	VZWD-L-M22C-M-N14-50-V-2AP4-5
					1492046	VZWD-L-M22C-M-N14-50-V-3AP4-5
		6	0 ... 4	600	1491886	VZWD-L-M22C-M-N14-60-V-1P4-4
					1491964	VZWD-L-M22C-M-N14-60-V-2AP4-4
					1492047	VZWD-L-M22C-M-N14-60-V-3AP4-4

1) The valves are suitable for vacuum with Pabs > 100 mbar. Please ensure the direction of flow corresponds to the direction of the arrow.

Solenoid valves VZWD, directly actuated, NPT

FESTO

Technical data – Brass housing, nominal pressure PN 100

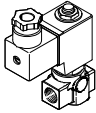
Ordering data						
	Process valve connection	Nominal size DN	Medium pressure ¹⁾ [bar]	Product weight [g]	Brass housing	
					Part No.	Type
	1/8 NPT	1	0 ... 90	550	1491949	VZWD-L-M22C-M-N18-10-V-2AP4-90
					1492027	VZWD-L-M22C-M-N18-10-V-3AP4-90
					1491871	VZWD-L-M22C-M-N18-10-V-1P4-90
		1.5	0 ... 85	550	1491950	VZWD-L-M22C-M-N18-15-V-2AP4-85
					1492028	VZWD-L-M22C-M-N18-15-V-3AP4-85
					1491872	VZWD-L-M22C-M-N18-15-V-1P4-85
		2	0 ... 40	550	1491951	VZWD-L-M22C-M-N18-20-V-2AP4-40
					1492029	VZWD-L-M22C-M-N18-20-V-3AP4-40
					1491873	VZWD-L-M22C-M-N18-20-V-1P4-40
	2.5	0 ... 22	550	1491952	VZWD-L-M22C-M-N18-25-V-2AP4-22	
				1492030	VZWD-L-M22C-M-N18-25-V-3AP4-22	
				1491874	VZWD-L-M22C-M-N18-25-V-1P4-22	
	3	0 ... 15	550	1491953	VZWD-L-M22C-M-N18-30-V-2AP4-15	
				1492031	VZWD-L-M22C-M-N18-30-V-3AP4-15	
				1491875	VZWD-L-M22C-M-N18-30-V-1P4-15	
	4	0 ... 8	550	1491954	VZWD-L-M22C-M-N18-40-V-2AP4-8	
				1492032	VZWD-L-M22C-M-N18-40-V-3AP4-8	
				1491876	VZWD-L-M22C-M-N18-40-V-1P4-8	

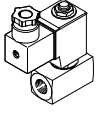
Ordering data						
	Process valve connection	Nominal size DN	Medium pressure ¹⁾ [bar]	Product weight [g]	Brass housing	
					Part No.	Type
	1/8 NPT	5	0 ... 5	600	1491877	VZWD-L-M22C-M-N18-50-V-1P4-5
					1491955	VZWD-L-M22C-M-N18-50-V-2AP4-5
					1492033	VZWD-L-M22C-M-N18-50-V-3AP4-5
	6	0 ... 4	600	1491878	VZWD-L-M22C-M-N18-60-V-1P4-4	
				1491956	VZWD-L-M22C-M-N18-60-V-2AP4-4	
				1492034	VZWD-L-M22C-M-N18-60-V-3AP4-4	

1) The valves are suitable for vacuum with Pabs > 100 mbar. Please ensure the direction of flow corresponds to the direction of the arrow.

Solenoid valves VZWD, directly actuated, NPT

Technical data – Stainless steel housing, nominal pressure PN 100

Function

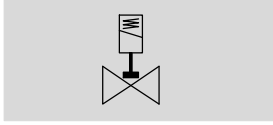

-  - Flow rate Kv
0.06 ... 0.4 m³/h

-  - Connecting thread
1/4 NPT, 1/8 NPT



General technical data								
Nominal size (DN)	1.0	1.5	2.0	2.5	3.0	4.0	5.0	6.0
Valve function	2/2-way, single solenoid, closed							
Design	Directly actuated poppet valve							
Type of mounting	In-line installation							
Actuation type	Electric							
Reset method	Mechanical spring							
Type of control	Direct							
Manual override	None							
Mounting position	Any							
Sealing principle	Soft							
Direction of flow	Non-reversible							
Max. viscosity [mm ² /s]	22							
Protection class	IP65							

Operating and environmental conditions								
Nominal size (DN)	1.0	1.5	2.0	2.5	3.0	4.0	5.0	6.0
Standard nominal flow rate [l/min]	60	95	140	170	210	310	375	430
Flow rate Kv [m ³ /h]	0.06	0.09	0.13	0.16	0.2	0.3	0.35	0.4
Process valve nominal pressure (PN)	100							
Medium	Compressed air in accordance with ISO 8573-1:2010 [7:4:4]							
	Inert gases							
	Mineral oil							
	Neutral liquids							
	Water							
	Further media upon request							
Differential pressure [bar]	0							
Ambient temperature [°C]	-10 ... +35 °C							
Temperature of medium [°C]	-10 ... +80 °C							
Leak rate to EN 12266-1	A							
Corrosion resistance class CRC ¹⁾	3							

1) Corrosion resistance class 3 according to Festo standard 940 070
Components subject to high corrosion stress. Externally visible parts with primarily decorative surface requirements which are in direct contact with a normal industrial environment or media such as solvents and cleaning agents.

Solenoid valves VZWD, directly actuated, NPT

Technical data – Stainless steel housing, nominal pressure PN 100

Electrical data		VZWD- ... 1	VZWD- ... 2A	VZWD- ... 3A
Electrical connection		Plug to EN 175301-803 type A, square design		
CE marking		–	73/23/EEC	73/23/EEC
Insulation class		H	F	F
Duty cycle	[%]	100		
Permissible voltage fluctuations	[%]	±10		
Coil characteristics	Direct current DC	[V]	24	–
	Alternating current AC	[V]	–	110
		[W]	11	–
	Pick-up power	[VA]	–	10.5
	Holding power	[VA]	–	8
		[Hz]	–	50, 60
	Switching time on	[ms]	20	
Switching time off	[ms]	18		

Materials		
Solenoid valves		Material number
1 Housing	High-alloy stainless steel	1.4305
2 Seals	FPM	
– Note on materials	Contains PWIS (paint-wetting impairment substances), RoHS-compliant	

Dimensions Download CAD data → www.festo.com/en/engineering

Type	B1	B2	B3	D1	D2	H1	H2	H3	H4	L1	L2	L3	L4	L5	T1	T2
VZWD-...-N1/8-50-...-5	25	30	15.5	1/8 NPT	M6	81	68	42.5	7	78	40	58	12	15.5	8	6
VZWD-...-N1/8-60-...-4																
VZWD-...-N1/4-50-...-5	25	30	15.5	1/4 NPT	M6	81	68	42.5	7	85	50	58	17	15.5	10	6
VZWD-...-N1/4-60-...-4																

Solenoid valves VZWD, directly actuated, NPT

Technical data – Stainless steel housing, nominal pressure PN 100

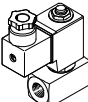
Ordering data – Solenoid valve VZWD						
	Process valve connection	Nominal size DN	Medium pressure ¹⁾ [bar]	Product weight [g]	Stainless steel casting housing	
					Part No.	Type
	1/4 NPT	1	0 ... 90	650	1491895	VZWD-L-M22C-M-N14-10-V-1P4-90-R1
					1491973	VZWD-L-M22C-M-N14-10-V-2AP4-90-R1
					1492090	VZWD-L-M22C-M-N14-10-V-3AP4-90-R1
		1.5	0 ... 85	650	1491896	VZWD-L-M22C-M-N14-15-V-1P4-85-R1
					1491974	VZWD-L-M22C-M-N14-15-V-2AP4-85-R1
					1492091	VZWD-L-M22C-M-N14-15-V-3AP4-85-R1
		2	0 ... 40	650	1491897	VZWD-L-M22C-M-N14-20-V-1P4-40-R1
					1491975	VZWD-L-M22C-M-N14-20-V-2AP4-40-R1
					1492092	VZWD-L-M22C-M-N14-20-V-3AP4-40-R1
		2.5	0 ... 22	650	1491898	VZWD-L-M22C-M-N14-25-V-1P4-22-R1
					1491976	VZWD-L-M22C-M-N14-25-V-2AP4-22-R1
					1492093	VZWD-L-M22C-M-N14-25-V-3AP4-22-R1
		3	0 ... 15	650	1491899	VZWD-L-M22C-M-N14-30-V-1P4-15-R1
					1491977	VZWD-L-M22C-M-N14-30-V-2AP4-15-R1
					1492094	VZWD-L-M22C-M-N14-30-V-3AP4-15-R1
		4	0 ... 8	650	1491900	VZWD-L-M22C-M-N14-40-V-1P4-8-R1
					1491978	VZWD-L-M22C-M-N14-40-V-2AP4-8-R1
					1492095	VZWD-L-M22C-M-N14-40-V-3AP4-8-R1
		5	0 ... 5	650	1491901	VZWD-L-M22C-M-N14-50-V-1P4-5-R1
					1491979	VZWD-L-M22C-M-N14-50-V-2AP4-5-R1
					1492096	VZWD-L-M22C-M-N14-50-V-3AP4-5-R1
		6	0 ... 4	650	1491902	VZWD-L-M22C-M-N14-60-V-1P4-4-R1
					1491980	VZWD-L-M22C-M-N14-60-V-2AP4-4-R1
					1492097	VZWD-L-M22C-M-N14-60-V-3AP4-4-R1

1) The valves are suitable for vacuum with Pabs > 100 mbar. Please ensure the direction of flow corresponds to the direction of the arrow.

Solenoid valves VZWD, directly actuated, NPT

Technical data – Stainless steel housing, nominal pressure PN 100

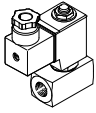
Ordering data – Solenoid valve VZWD						
	Process valve connection	Nominal size DN	Medium pressure ¹⁾ [bar]	Product weight [g]	Stainless steel casting housing	
					Part No.	Type
	1/8 NPT	1	0 ... 90	500	1491887	VZWD-L-M22C-M-N18-10-V-1P4-90-R1
					1491965	VZWD-L-M22C-M-N18-10-V-2AP4-90-R1
					1492048	VZWD-L-M22C-M-N18-10-V-3AP4-90-R1
		1.5	0 ... 85	500	1491888	VZWD-L-M22C-M-N18-15-V-1P4-85-R1
					1491966	VZWD-L-M22C-M-N18-15-V-2AP4-85-R1
					1492049	VZWD-L-M22C-M-N18-15-V-3AP4-85-R1
		2	0 ... 40	500	1491889	VZWD-L-M22C-M-N18-20-V-1P4-40-R1
					1491967	VZWD-L-M22C-M-N18-20-V-2AP4-40-R1
					1492050	VZWD-L-M22C-M-N18-20-V-3AP4-40-R1
		2.5	0 ... 22	500	1491890	VZWD-L-M22C-M-N18-25-V-1P4-22-R1
					1491968	VZWD-L-M22C-M-N18-25-V-2AP4-22-R1
					1492051	VZWD-L-M22C-M-N18-25-V-3AP4-22-R1
		3	0 ... 15	500	1491891	VZWD-L-M22C-M-N18-30-V-1P4-15-R1
					1491969	VZWD-L-M22C-M-N18-30-V-2AP4-15-R1
					1492052	VZWD-L-M22C-M-N18-30-V-3AP4-15-R1
		4	0 ... 8	500	1491892	VZWD-L-M22C-M-N18-40-V-1P4-8-R1
					1491970	VZWD-L-M22C-M-N18-40-V-2AP4-8-R1
					1492053	VZWD-L-M22C-M-N18-40-V-3AP4-8-R1
		5	0 ... 5	500	1491893	VZWD-L-M22C-M-N18-50-V-1P4-5-R1
					1491971	VZWD-L-M22C-M-N18-50-V-2AP4-5-R1
					1492054	VZWD-L-M22C-M-N18-50-V-3AP4-5-R1
		6	0 ... 4	500	1491894	VZWD-L-M22C-M-N18-60-V-1P4-4-R1
					1491972	VZWD-L-M22C-M-N18-60-V-2AP4-4-R1
					1492055	VZWD-L-M22C-M-N18-60-V-3AP4-4-R1

1) The valves are suitable for vacuum with Pabs > 100 mbar. Please ensure the direction of flow corresponds to the direction of the arrow.