

Bag cups

Select the  
optimum  
bag cup

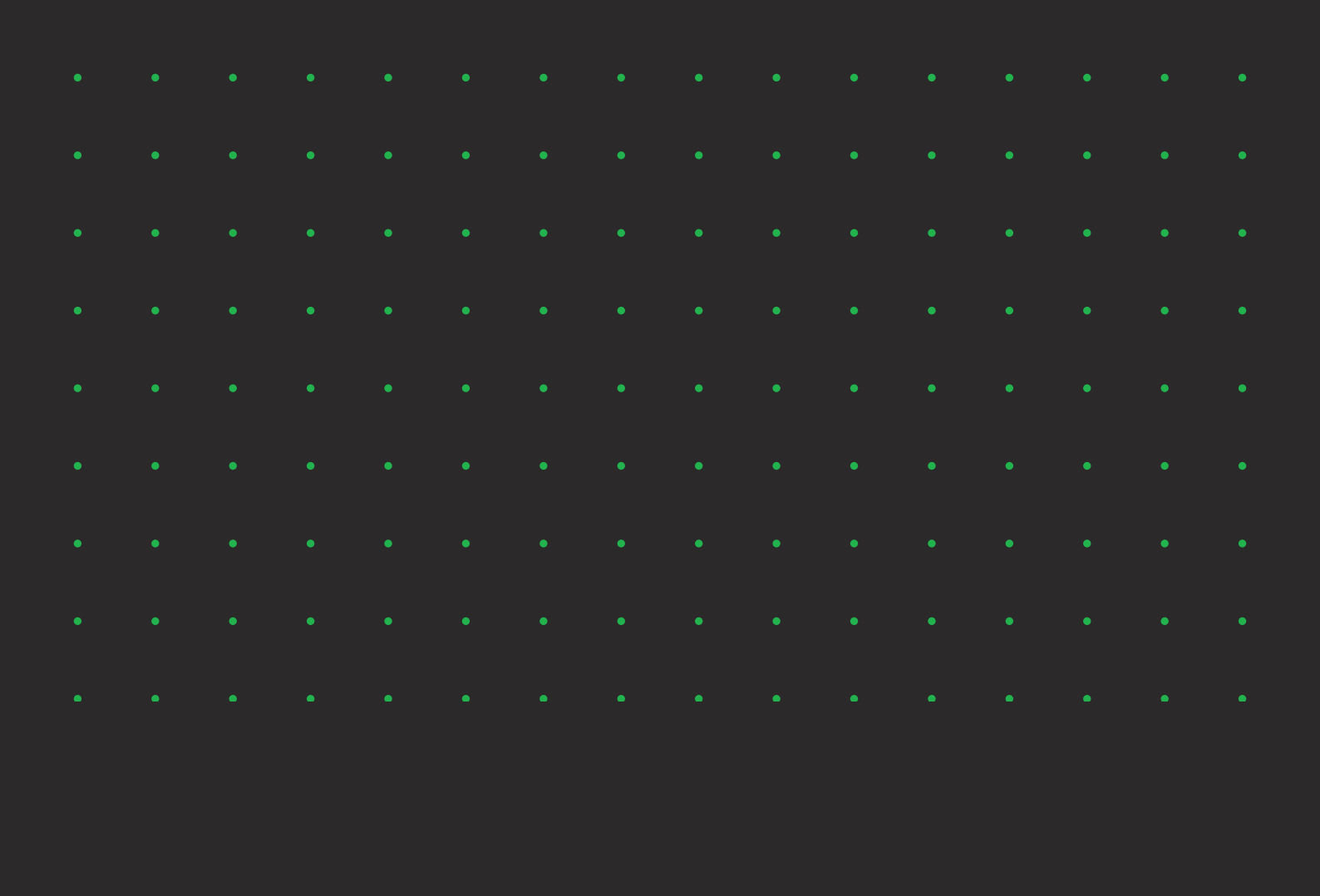



# Evolving ourselves. Evolving you. Evolving automation.

To enable our customers to automate any step within their process chain, we focus on the continuous development of state-of-the-art products and solutions in suction cups and soft grippers, robot and cobot gripping solutions, end-of-arm-tools (EOATs) and palletizing solutions, vacuum ejector pumps and ejectors.

Piab's vacuum generators are the market's most energy efficient ejectors, as confirmed in independent comparative tests by the Fraunhofer Institute IWU in Dresden, Germany. As true innovators, we do not copy others, we lead.

# Index

<b>It's all about bags</b>	<b>5</b>
Vacuum meets suction cup	6
<b>Common bag types</b>	<b>7</b>
Thin foil bags	9
Frozen food bags	9
Stand-up bags/pouches	10
Liquid filled bags	10
Cellophane bags	11
Thin flimsy bags	11
Oversized bags	12
Flow packs	12
<b>Bag cup selection guide</b>	<b>13</b>
<b>Suction cups for bag handling</b>	<b>15</b>
BGX – The perfect flimsy bag picker	16
BGI – The modular bag picker	17
MX – The #1 item picker	18
BL – A family of bag handlers	19
RBL – Rectangular/square cups	20
General cups good for bag handling	21
<b>More solutions for your bags</b>	<b>22</b>
Flexible Suction Cup Mount	22
piCOMPACT®	23
Kenos® sack gripper	23



# It's all about bags

No bag is the same as the next one. From the material they are made of to whether they are filled or not, their characteristics add to the complexity of the bag handling challenge.

We all use bags every day and for all sorts of reasons. However, for us at Piab, bag handling is about bags used for items or products that weigh no more than a couple of kilos, such as food and beverage, household products, clothes, cosmetics, DIY goods, etc. Of course, we also offer handling solutions for larger bags or sacks.

Our solutions for automated bag handling rely on our long-standing expertise in vacuum and ejector technology and the use of our specialized suction cups. With 20 years of experience in developing bag handling cups, we constantly challenge ourselves to create new cups for increasingly targeted applications supporting the success of our customers. The latest addition to our bag cup portfolio, the BGX cup is particularly suitable for flimsy and oversized bags.

A successful bag cup must suit both the bag itself and its content. We make cups suitable for handling bags made of thin plastic film, aluminium foil, paper, as well as new sustainable, eco-friendly

and/or recycled/recyclable materials. Some of our cups excel in handling sturdy stand-up bags or pouches. Other cups are perfect for handling fragile bags and contents. Bags/pouches containing food or beverage need to be handled by cups made of a food contact material (FCM). And then, there are the cups that can handle almost everything.

The trick is to make a suction cup that creates an efficient seal so that vacuum isn't lost, ensuring that bags can be safely gripped, lifted, and moved. And that is one of Piab's core strengths. With the knowledge of vacuum technology and gripping solutions, all the way from vacuum engines to suction cups, we offer excellent customer support and a global reach.

This brochure will help you select the best suitable cup for your specific bag handling application. For any further support, our experts are just near you.



# Vacuum meets suction cup

Suction cups offer endless possibilities for gripping, lifting and moving needs. You can handle board materials, food or other items, open bags, pick electronic components, label and hold objects, for example. However, in different automated applications, you need to fulfil different needs and requirements.

Several conditions should be considered to meet those requirements, and the vacuum system and the suction cup perfectly matched. The most difficult items to pick are the bags since they do not have an even surface and, depending on their content, are very dynamic when gripped. The height differences can be compensated for utilizing cups with bellows. But for the perfect and stable grip, an appropriate and constant vacuum level is needed.

The lifting force of a suction cup is determined as vacuum level x area covered. The vacuum is

generated when the suction cup seal against a surface and air is taken out of the cup. The atmospheric pressure outside the cup presses down on the low-pressure area inside the cup and creates the suction force.

The challenge is to seal properly and to avoid any leakage. Here, leakage refers to air entering the cup via either non-sealing lips or porous packaging materials, such as paper. Minor leakage can be compensated by increasing the vacuum flow. Using a vacuum pump, the entered air in the cup can be constantly evacuated and the vacuum level maintained, keeping the object's grip stable. Higher levels of the vacuum and flow do not always give better performance, and therefore the right vacuum setting for the utilized suction cup in different applications is crucial.



**Lennart Ryberg**

Global Product Manager suctioncups

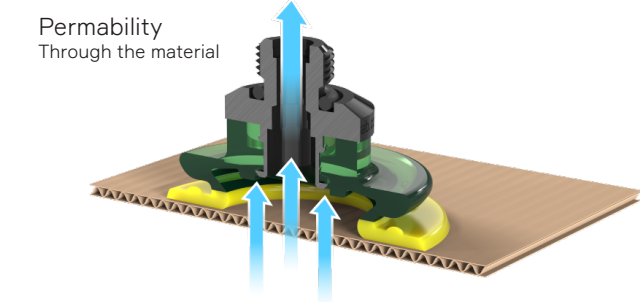
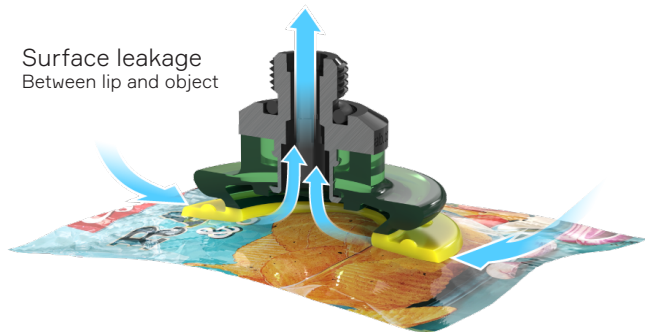
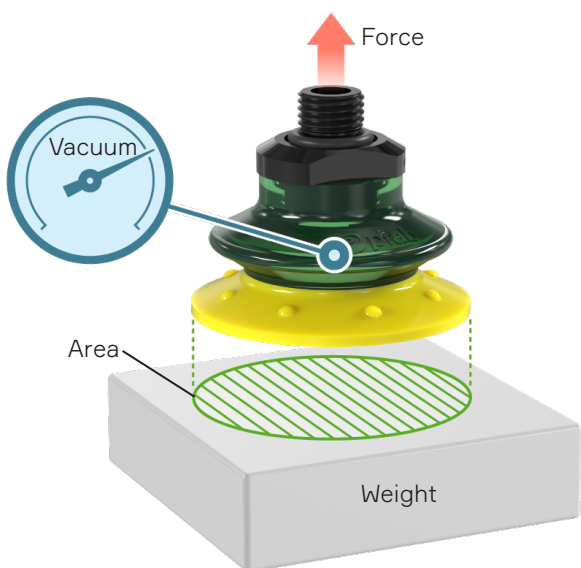

In many automated handling applications, vacuum and suction cups grip and move the bags. Different characteristics of the bag require different bag handling solutions. With the knowledge of vacuum technology and gripping solutions, Piab offers one of the market's widest ranges of suction cups so that each application will have a suitable solution.

# Common bag types



## Thin foil bags

This is a bag with plastics and a thin aluminium foil. Compared to just a plastic bag, the surface becomes stiffer due to the aluminium foil. Usually, this is found in bags containing cheese doddles, potato chips, other snack bags etc.

The foil is used to keep the freshness inside, and nothing, in this case, can beat aluminium. The aluminium acts as an oxygen barrier and keeps out moisture. The bags are often filled with nitrogen, creating an "air-cushion" so the content is not crushed.

The challenge here is not usually the weight. The suction cup lip needs to be able to adapt to the semi wrinkled surface.



## Frozen food bags

Frozen food bags are thicker than regular food bags, making them tougher and more durable when storing food in the freezer. But they often look and feel pretty similar to other plastic storage bags. Frozen food packaging bags are a great option for brands with products such as frozen vegetables, meats, prepared meals, and the like, to meet the needs of consumers who are short on time but don't want to sacrifice the quality of the food and ingredients.

This type of bag usually puts direct demand on the suction cup material itself. It needs to be able to cope with low temperatures, and most likely, the suction cup user will demand FCM approved material.





### Do you want to know more?

Take a look at the online product page: [www.piab.com](http://www.piab.com)

## Stand-up bags/pouches

This bag type is quite sturdy and thick in order to give the stand-up functionality required. Those bags are used for everyday dry goods such as cat biscuits, dishwasher tablets, and chocolate treats or liquids such as juice, soap, and soup. Sturdy stand-up bags/pouches are very popular among producers of a broad range of domestic products.

Although the bags/pouches are made of non-porous materials, they will wrinkle when handled, creating “holes” and crevices that need to be sealed. Suction cups with thin, flexible lips will wrinkle with the bag/pouch, providing an excellent all-around seal, resulting in a safe and secure grip. Their great sealing performance also ensures more energy-efficient vacuum handling.



## Liquid filled bags

Liquid filled bags. This is a liquid-filled non stand-up pouch bag, and compared to a stand-up bag, the bag has a thinner plastic material but is still very durable. Liquid pouches are commonly used for packaging hot sauce, ketchup, barbeque sauce, mustard, relish, energy drinks, nut butter, liquid dietary supplements, industrial liquids, and many other types of liquid products. Liquid pouches are an excellent choice for packaging liquids, commonly found inside a “Bag in Box”.

A suction cup for this type of application needs to be flexible enough, meaning it has to seal of the surface in a good way. The challenge is the moving liquid content in the bag, constantly changing the structure.



## Cellophane bags

E-commerce is booming, and more and more people are buying clothes and other fashion items online. These bags are thin, rigid plastic bags. Anyone who has done so knows that the merchandise usually arrives in branded bags. Fast-paced online businesses require automatic handling systems in which bags are handled quickly and efficiently yet still gentle enough not to damage goods or wrinkle clothes and tear or spoil the manufacturers' bags.

Suction cups designed for low vacuum levels will provide a sufficiently strong grip on fashion bags to be used in fast or semi-fast robot applications.

## Thin flimsy bags

Bags made of very thin plastic film, such as those used for salad leaves and fresh herbs, are sometimes just as fragile as their contents. Items packed in this kind of bag could also be clothing. New biodegradable and recyclable materials are becoming increasingly popular.

Common to them all is that they need to be handled with care. The thinner and flimsier a bag is, the easier it is to be sucked into and be damaged by the cup gripping it. So, to get a good grip on a thin, flimsy bag without damaging them or its contents, the lips of the suction cups need to provide outstanding sealing capability even at low vacuum levels.





## Oversized bags

Bags used for intra logistics/shipping are often larger than needed as they must be able to hold a variety of items. Such "oversized bags" can sometimes behave as if they were empty, but as they are not, they need to be gripped and handled safely and efficiently. The material is quite thin and the bags are easily sucked into the suction cup, where they can get stuck. In addition, heavily wrinkled bags will cause leakage, potentially resulting in loss of vacuum and grip.

The combination of low vacuum levels, suction cup lips designed for improved sealing and an ability to separate thin films/foils will considerably aid the handling of oversized bags where sections of the bag might not be filled. Bellows and a stable neck also help cups overcome problems faced in this challenging application.

## Flow pack











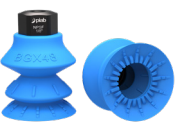



This is a type of packaging with which a wide variety of products can be packed in an organized way, either separately or on a tray. Flow wrapping is commonly used for delicate products, single-serve goods, products in trays, and much more. This includes energy bars, sponges, ice cream on a stick, cleaning wipes, pastries, desserts, napkins, pre-wrapped plastic cutlery, flea collars, coffee filters, etc.

The process of the flow pack machine is relatively simple and delivers a thoroughly sealed package which increases the shelf life of the packed produce. Therefore, the flow packer is in much use across the entire world and is typically distinguished by the packing process from a roll of thin flat plastic foil. One of the most significant benefits of a flow wrapping machine is its extremely high capacity for a relatively low cost. Flow packs are generally thin packages around structured content. The bag is kept in place by the content, which is an important factor in selecting a suction cup.

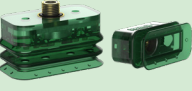

# Bag cup selection guide

This table captures the overview of bag cups and aims to sort out the differences between them and help select the right cup for the different applications. The selection guide is intended to give guidelines when choosing the most appropriate cup and does not represent the final solution. The selected cups should always be validated and tested in the selection process.

	Features					Applications	
	Available Sizes (mm)	FDA/EU food grade material	Low/High temp applications <5°C [41°F] >50°C [121°F]	Requires higher vacuum flows	High speed applications <sup>4</sup>	Thin foil bags	Frozen food bags
<p> <input checked="" type="checkbox"/> = Yes  <input type="checkbox"/> = Not applicable  <input checked="" type="radio"/> = Excellent  <input checked="" type="radio"/> = Very good  <input type="radio"/> = Good  <input type="radio"/> = Not recommended                 </p> 	 Ø34, Ø41, Ø48						
BGX	Ø34, Ø41, Ø48	<input checked="" type="checkbox"/>	<input checked="" type="checkbox"/>	<input type="checkbox"/>	<input checked="" type="checkbox"/>	<input checked="" type="radio"/> <input checked="" type="radio"/> <input checked="" type="radio"/>	<input checked="" type="radio"/> <input checked="" type="radio"/> <input type="radio"/>
	Ø25, Ø34, Ø41, Ø48, Ø63, Ø80	<input checked="" type="checkbox"/>	<input checked="" type="checkbox"/> <sup>1</sup>	<input type="checkbox"/>	<input checked="" type="checkbox"/> <sup>2</sup>	<input checked="" type="radio"/> <input checked="" type="radio"/> <input checked="" type="radio"/>	<input checked="" type="radio"/> <input checked="" type="radio"/> <input type="radio"/>
piGRIP® BGI	Ø25, Ø34, Ø41, Ø48, Ø63, Ø80	<input checked="" type="checkbox"/>	<input checked="" type="checkbox"/> <sup>1</sup>	<input type="checkbox"/>	<input checked="" type="checkbox"/> <sup>2</sup>	<input checked="" type="radio"/> <input checked="" type="radio"/> <input checked="" type="radio"/>	<input checked="" type="radio"/> <input checked="" type="radio"/> <input type="radio"/>
	Ø35, Ø42, Ø50, Ø57, Ø65	<input type="checkbox"/>	<input type="checkbox"/>	<input type="checkbox"/>	<input checked="" type="checkbox"/>	<input checked="" type="radio"/> <input checked="" type="radio"/> <input checked="" type="radio"/>	<input type="radio"/> <input type="radio"/> <input type="radio"/>
MX	Ø35, Ø42, Ø50, Ø57, Ø65	<input type="checkbox"/>	<input type="checkbox"/>	<input type="checkbox"/>	<input checked="" type="checkbox"/>	<input checked="" type="radio"/> <input checked="" type="radio"/> <input checked="" type="radio"/>	<input type="radio"/> <input type="radio"/> <input type="radio"/>
	20x45, 30x55, 60x60	<input type="checkbox"/>	<input type="checkbox"/>	<input type="checkbox"/>	<input checked="" type="checkbox"/> <sup>3</sup>	<input type="radio"/> <input type="radio"/> <input type="radio"/>	<input type="radio"/> <input type="radio"/> <input type="radio"/>
RB/RBL	20x45, 30x55, 60x60	<input type="checkbox"/>	<input type="checkbox"/>	<input type="checkbox"/>	<input checked="" type="checkbox"/> <sup>3</sup>	<input type="radio"/> <input type="radio"/> <input type="radio"/>	<input type="radio"/> <input type="radio"/> <input type="radio"/>
	Ø30, Ø40, Ø50	<input checked="" type="checkbox"/>	<input checked="" type="checkbox"/>	<input checked="" type="checkbox"/>	<input type="checkbox"/>	<input checked="" type="radio"/> <input type="radio"/> <input type="radio"/>	<input checked="" type="radio"/> <input checked="" type="radio"/> <input type="radio"/>
BL-5	Ø30, Ø40, Ø50	<input checked="" type="checkbox"/>	<input checked="" type="checkbox"/>	<input checked="" type="checkbox"/>	<input type="checkbox"/>	<input checked="" type="radio"/> <input type="radio"/> <input type="radio"/>	<input checked="" type="radio"/> <input checked="" type="radio"/> <input type="radio"/>
	Ø30, Ø40, Ø50	<input checked="" type="checkbox"/>	<input checked="" type="checkbox"/>	<input checked="" type="checkbox"/>	<input type="checkbox"/>	<input checked="" type="radio"/> <input checked="" type="radio"/> <input type="radio"/>	<input checked="" type="radio"/> <input type="radio"/> <input type="radio"/>
BL-4	Ø30, Ø40, Ø50	<input checked="" type="checkbox"/>	<input checked="" type="checkbox"/>	<input checked="" type="checkbox"/>	<input type="checkbox"/>	<input checked="" type="radio"/> <input checked="" type="radio"/> <input type="radio"/>	<input checked="" type="radio"/> <input type="radio"/> <input type="radio"/>
	Ø30, Ø40, Ø50	<input type="checkbox"/>	<input type="checkbox"/>	<input checked="" type="checkbox"/>	<input checked="" type="checkbox"/>	<input checked="" type="radio"/> <input type="radio"/> <input type="radio"/>	<input type="radio"/> <input type="radio"/> <input type="radio"/>
BL-3	Ø30, Ø40, Ø50	<input type="checkbox"/>	<input type="checkbox"/>	<input checked="" type="checkbox"/>	<input checked="" type="checkbox"/>	<input checked="" type="radio"/> <input type="radio"/> <input type="radio"/>	<input type="radio"/> <input type="radio"/> <input type="radio"/>
	Ø20, Ø30, Ø40, Ø50	<input checked="" type="checkbox"/>	<input checked="" type="checkbox"/>	<input checked="" type="checkbox"/>	<input type="checkbox"/>	<input type="radio"/> <input type="radio"/> <input type="radio"/>	<input type="radio"/> <input type="radio"/> <input type="radio"/>
BL-2	Ø20, Ø30, Ø40, Ø50	<input checked="" type="checkbox"/>	<input checked="" type="checkbox"/>	<input checked="" type="checkbox"/>	<input type="checkbox"/>	<input type="radio"/> <input type="radio"/> <input type="radio"/>	<input type="radio"/> <input type="radio"/> <input type="radio"/>

<sup>1</sup> Lip with good temperature features

<sup>2</sup> Not the 25mm lip

<sup>3</sup> High speeds but not extreme







<sup>4</sup> >60 cycle/min



**Do you want to know more?**

Take a look at the online product page: [www.piab.com](http://www.piab.com)

## Applications

Stand-up bags/pouches	Liquid filled bags	Cellophane bags	Flimsy bags	Oversized bags	Flow pack
					
● ● ○	● ● ●	● ● ●	● ● ●	● ● ●	● ● ○
● ● ●	● ○ ○	● ● ○	● ● ○	● ● ○	● ● ○
● ● ○	● ● ○	● ● ○	● ● ○	● ● ○	● ● ○
● ● ○	○ ○ ○	○ ○ ○	● ○ ○	● ○ ○	● ● ●
● ● ○	○ ○ ○	○ ○ ○	○ ○ ○	○ ○ ○	● ○ ○
● ○ ○	○ ○ ○	● ○ ○	● ○ ○	● ○ ○	● ○ ○
● ○ ○	○ ○ ○	● ○ ○	● ● ○	● ○ ○	● ● ○
● ○ ○	○ ○ ○	○ ○ ○	● ○ ○	○ ○ ○	● ○ ○

Whether your bag is made of thin plastic film, aluminium foil, paper, or sustainable, eco-friendly materials with fragile or fluid content Piab has suction cups to handle them all. And we constantly challenge ourselves to create new suction cups for increasingly targeted applications supporting your success.

# Suction cups for bag handling



# BGX – The perfect flimsy bag picker

The **BGX bag cup** has been developed as the perfect bag picker for flimsy and oversized bags and provides a superb grip on challenging bag surfaces. The suction cups are made in FDA & EU approved blue silicone for direct contact with food and are suitable for both high and low-temperature applications.

The design of the lip gives outstanding sealing capability at low vacuum levels. Produced as a one-piece suction cup with two bellows, the suction cup will easily pick bags of different heights with a safe and stable hold of the product in the fast/semi-fast robot applications.



FDA/EU food grade



Low/High temp applications



High speed applications

The suction cup can be configured by choosing between 3 sizes of lip diameters 34, 41, and 48 mm and 6 different aluminium push-in fittings designed to attach safely to the robust neck of the cups.





# piGRIP® BGI – the modular bag picker



Piab's BGI bag lips from the configurable piGRIP® family provide a good grip on many different bags. Made in a durable and FDA & EU approved material, they are the perfect choice for lifting both sturdy plastic bags and stand-up pouches filled with dry or wet food/substances and liquids. The enhanced BGI-2 lips also provide an improved grip on thin, flimsy, and fragile plastic bags.

 FDA/EU food grade

 Low/High temp applications

 High speed applications

As part of the configurable piGRIP® family, the BGI bag lips offer a wide range of

opportunities to create the perfect bag picking application. piGRIP® enables users to select all parts - lips, bellows, supports and fittings - to match their specific needs.

To improve their gripping performance, the lips include a high flow retainer that prevents thin bags or films to be sucked into the cup. The unique cleat design spreads the vacuum flow and allows the thin lip to wrinkle in a controlled way together with the bag to achieve a good seal. Extra depth prevents the bag from sealing towards the bellows opening and helps the lip to move inwards when gripping.

For best performance and durability, operating vacuum levels of around -40kPa are recommended. The lips are replaceable, and all suction cup parts are recyclable.

The original BGI lips are available in diameters from 25 to 80 mm, and the BGI-2 lips in the diameters 34, 41, 48, and 63 mm.



# MX – #1 item picker



**MX cups are outstanding** for picking various objects of different materials, including difficult bags and pouches of varying shape, size, and material. Designed primarily for logistics, warehousing, e-commerce and re-cycling applications, these multi-purpose suction cups have extreme gripping capabilities and are the perfect choice for a thin plastic bag not completely filled with quite heavy objects such as screws.

The cups are highly engineered and specifically made to support picking of multiple types of objects or bags. The cups are compatible with all piGRIP® fittings and their features. Their low vacuum design saves energy and makes them perfect for small vacuum systems such as piCOBOT®.

The cups are made up of components of three different levels of hardness:

- Soft, thin lips, providing exceptional vacuum sealing capabilities.
- Sturdy, but easily folding bellows for great holding force in dynamic grips.
- Firm necks for a safe and sturdy interface for a variety of fitting options, including aluminium clamp fittings.

⇒  ⇒  
High speed applications

**Thanks to their exceptional** sealing capabilities, lower vacuum levels (-30 or -40 kPa) can be used to avoid wrinkling of bags, enabling these to be reused. The DURAFLEX® material contributes to the longevity of the cup.



# BL – a family of bag handlers

The BL-2 silicone cup have a soft, flexible lip and are suitable for bags that are not too tightly packed. Its four bellows offer good level compensation. Available in diameters from 20 to 50 mm, the cups are made in regular silicone or FDA & EU approved transparent silicone for direct contact with food. Both offer a wide temperature range for applications.

The BL-3 DURAFLEX® cup has a specially designed fitting that allows high initial flow needed for a secure grip on bags that are not packed tightly. Its dual hardness design offers great sealing due to a soft lip and stability thanks to the harder bellows.

Available in diameters from 30 to 50 mm, the BL-3 cups are available only in Piab's long lasting, high tear resistance material DURAFLEX®, offering a long working life under normal temperature conditions.



FDA/EU food grade



Low/High temp applications



Requires higher vacuum flows



High speed applications



The BL-4 cup is designed for bags with fragile content such as snacks or frozen food. To suit this application, it is equipped with a longer lip and cleats. Available in diameters from 30 to 50 mm, the cups are made in silicone, making them suitable for use in a wide range of temperatures.

The BL-5 cup is particularly suitable for heavy bags or bags filled with liquid or frozen food. Designed for high initial flow, it has reinforced bellows and a long, thin lip. The cups are available in diameters from 30 to 50mm and are made from silicone. They are not suitable for deep vacuum levels.

Both BL-4 and BL-5 cups use the same type of high flow fitting as BL-3 and are available in FDA & EU approved silicone, coloured transparent for easy identification.

# RB/RBL – for oblong objects



High speed applications



RBL cups are Piab's family of rectangular and square bellows cups, all configurable with many fitting options. Originally developed for flow-pack packaging machines, RBL cups are handy for lifting thin paper bags or bags made of slip sheets or plastic film.

Also recommended for handling long, narrow bags, the RBL are particularly useful when maximum lifting force and grip are required, as the active lifting area is larger for rectangular cups compared with round or oval ones.

Available in Piab's long lasting, high tear resistance, non-marking material DURAFLEX®, the cups have a long working life and work in normal temperatures. Several different fittings are available, including aluminium T-slot fittings and swivelling fittings that allow for an easy positioning and locking function.

Piab's RBL family of mainly rectangular bellows cups are also nimble bag openers.

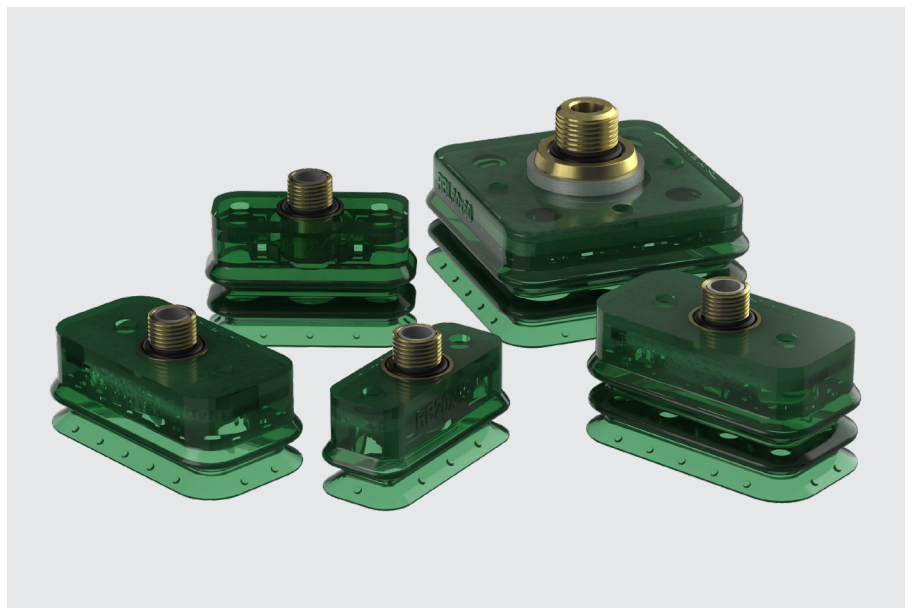

# F - Bag opening cups

Piab's range of bag cups also include cups that are ideal for bag opening. This task sees cups gripping, opening, and then keeping bags open while these are being filled.

F26 and F33 are two such bag opening cups. Both are flat cups with cleats, specially optimized for bag opening and thin sheets. Their thin, conformable lip and clever cleat pattern prevent sensitive bags from getting sucked in and damaged while providing enhanced lifting force. Developed together with a world leading manufacturer of form-fill-seal machines, the F26 and F33 cups are made of silicone and are compliant with FDA & EU standards for use with food.

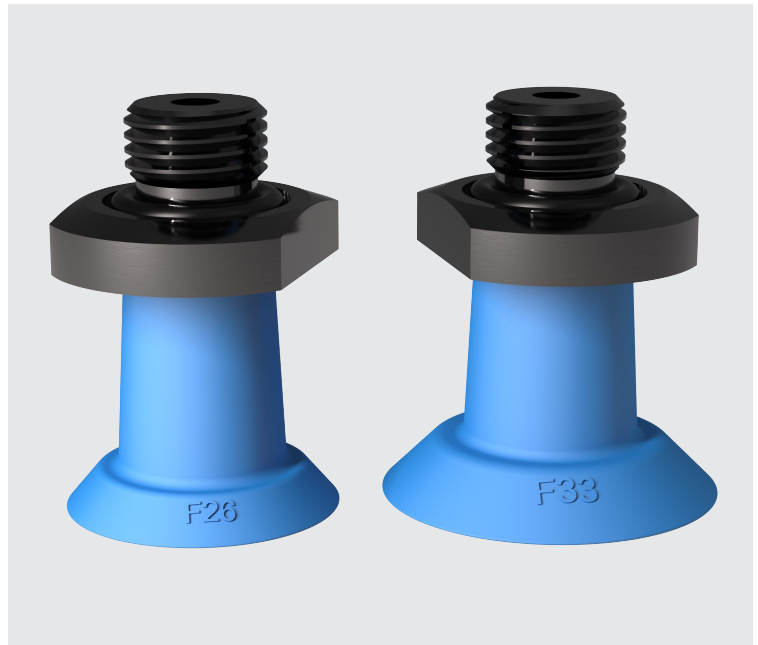

# More solutions for your bags

Piab offers a wide range of products to complement your bag handling solutions to further support the automated processes. This covers everything from suction cups for bags and mounting elements to vacuum pumps and sack grippers.

## Flexible suction cup mount

Flexible suction cup mount (FSCM) is a tool to help you maximize productivity with easy installation and maximum flexibility when putting your suction cups in place. The components fit a large variety of fixtures and tooling used thanks to its easy compliance with industry standards.

The high angle adjustment and various rod lengths options allow precise and simple positioning of suction cups in tight spaces. Its installation is simple thanks to a designed drop-in replacement mounting option as well as a variety of other fastening possibilities. The tooling can be easily adapted to existing vacuum systems, whether centralized or decentralized, due to a large selection of configurable sizes, lengths and fittings options.



# piCOMPACT®

piCOMPACT® is a vacuum ejector with integrated control functions for on/off blow vacuum sensing and diagnostics. The vacuum pumps/vacuum generators are predominately based on the patented COAX® technology of Piab, which is an advanced solution for creating a vacuum with compressed air. COAX® ejectors are up to twice as fast as other ejectors and deliver three times more flow than conventional vacuum ejectors with identical air consumption.

The piCOMPACT® family is tailor-made for automated processes using vacuum handling applications. It comes with performance, low weight, installation flexibility, product reliability and special features to improve productivity and profitability.

A piCOMPACT® can be individually configured to meet the specific application's requirements and needs.

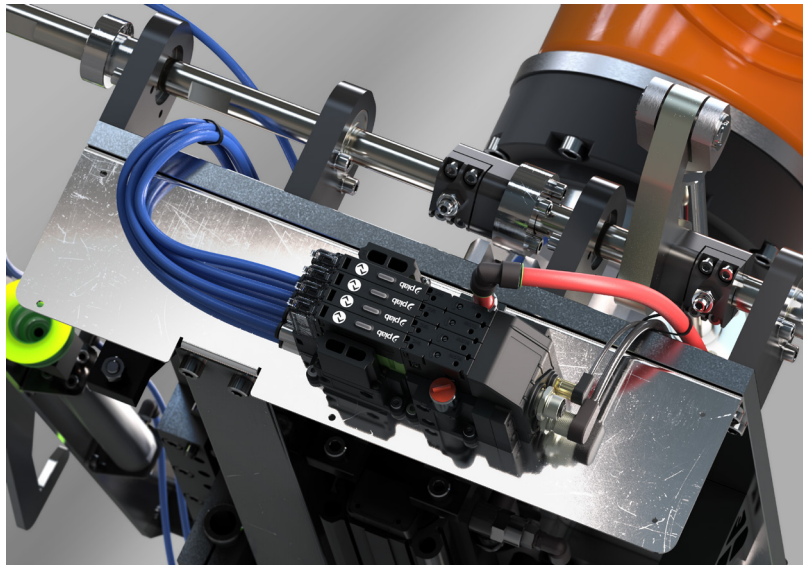

# Kenos® sack gripper

Kenos® vacuum grippers are available in different shapes and sizes to meet the demands of various applications. The Kenos® Sack Grippers (KSG) series are suitable for handling sacks of different shapes, weights, and materials. They are also suitable for applications when FDA requirements are needed.

The integrated and modular vacuum generators make the KSG flexible, reliable and easy to maintain. As an alternative, the KSG system can be used using external vacuum generation with a side channel blower. The grippers can be configured for the specific application in the configurator.



# Evolving around the world

## EUROPE

### France

Lagny sur Marne  
+33 (0)16-430 82 67  
info-france@piab.com

### Germany

Butzbach  
+49 (0)6033 7960 0  
info-germany@piab.com

### Italy

Torino  
+39 (0)11-226 36 66  
info-italy@piab.com

### Poland

Gdansk  
+48 58 785 08 50  
info-poland@piab.com

### Spain

Barcelona  
+34 (0)93-633 38 76  
info.spain@piab.com

### Sweden

Täby (HQ)  
+46 (0)8-630 25 00  
info-sweden@piab.com

Kungsbacka  
Lifting Automation  
+46 (0)300-185 00  
eh.info@piab.com

### United Kingdom

Loughborough  
+44 (0)15-098 570 10  
info-uk@piab.com

## AMERICAS

### Brazil

Sao Paulo  
+55 (0)11-449 290 50  
info-brasil@piab.com

### Canada

Toronto (ON)  
Lifting Automation  
+1 (0)905-881 16 33  
eh.ca.info@piab.com

### Hingham (MA, US)

+1 800 321 7422  
info-usa@piab.com

### Mexico

Hingham MA (US)  
+1 781 337 7309  
info-mxca@piab.com

### USA

Hingham (MA)  
+1 800 321 7422  
info-usa@piab.com

Xenia (OH)  
Robotic Gripping  
+1 888 727 3628  
info-usa@piab.com

## ASIA

### China

Shanghai  
+86 21 5237 6545  
info-china@piab.com

### India

Pune  
+91 8939 15 11 69  
info-india@piab.com

### Japan

Tokyo  
+81 3 6662 8118  
info-japan@piab.com

### Singapore

Singapore  
+65 6455 7006  
info-singapore@piab.com