



aerospace
climate control
electromechanical
filtration
fluid & gas handling
hydraulics
pneumatics
process control
sealing & shielding



Pneumatic cylinders

Series P5T
Short Stroke Thrusters

Catalogue PDE2557TCUK September 2014



ENGINEERING YOUR SUCCESS.

P5T Short Stroke Thrusters

Features	Air cylinder	Hydraulic cylinder	Electro mechanical actuators
Overload safe	***	***	*
Easy to limit force	***	***	*
Easy to vary speed	***	***	*
Speed	***	**	**
Reliability	***	***	***
Robustness	***	***	*
Installation cost	***	*	**
Ease of service	***	**	*
Safety in damp environments	***	***	*
Safety in explosive atmospheres	***	***	*
Safety risk with electrical installations	***	***	*
Risk of oil leak	***	*	***
Clean, hygienic	***	**	*
Standardised measurements	***	***	*
Service life	***	***	*
Hydraulic system required	***	*	***
Weight	***	**	**
Purchase price	***	**	*
Power density	**	***	*
Noise level during operation	**	***	**
High force for size	**	***	*
Positioning possibilities	*	***	***
Total energy consumption	*	**	***
Service interval	*	**	***
Compressor capacity required	*	***	***

* = good, **=average, ***=excellent



Important
 Before attempting any external or internal work on the cylinder or any connected components, make sure the cylinder is vented and disconnect the air supply in order to ensure isolation of the air supply.



Note
 All technical data in this catalogue are typical data only.
 Air quality is essential for maximum cylinder service life (see ISO 8573).



WARNING

FAILURE OR IMPROPER SELECTION OR IMPROPER USE OF THE PRODUCTS AND/OR SYSTEMS DESCRIBED HEREIN OR RELATED ITEMS CAN CAUSE DEATH, PERSONAL INJURY AND PROPERTY DAMAGE.

This document and other information from Parker Hannifin Corporation, its subsidiaries and authorized distributors provide product and/or system options for further investigation by users having technical expertise. It is important that you analyze all aspects of your application and review the information concerning the product or system in the current product catalog. Due to the variety of operating conditions and applications for these products or systems, the user, through its own analysis and testing, is solely responsible for making the final selection of the products and systems and assuring that all performance, safety and warning requirements of the application are met. The products described herein, including without limitation, product features, specifications, designs, availability and pricing, are subject to change by Parker Hannifin Corporation and its subsidiaries at any time without notice.

SALE CONDITIONS

The items described in this document are available for sale by Parker Hannifin Corporation, its subsidiaries or its authorized distributors. Any sale contract entered into by Parker will be governed by the provisions stated in Parker's standard terms and conditions of sale (copy available upon request).

Contents	Page
P5T Cylinder, general information.....	4-5
Cylinder forces.....	6
Working medium, air quality	6
Main data	7
Material specification	7
Guide for selecting suitable tubing	8
Valve series with respective flows in NI/minute	9
Dimensions, P5T	10-12
Maximum load.....	13
Maximum Torsional Capacity for Symmetrical Torsion	14
Maximum Torsional Capacity for Asymmetrical Torque	15
Maximum load during vertical lift	16
Maximum loading as a stop cylinder	17
Ordering key	18
Standard strokes	18
Order code standard strokes, double acting P5T with plain bearing	19
Sensors	20-24
Seal kits and grease	25

P5T Short Stroke Thrusters

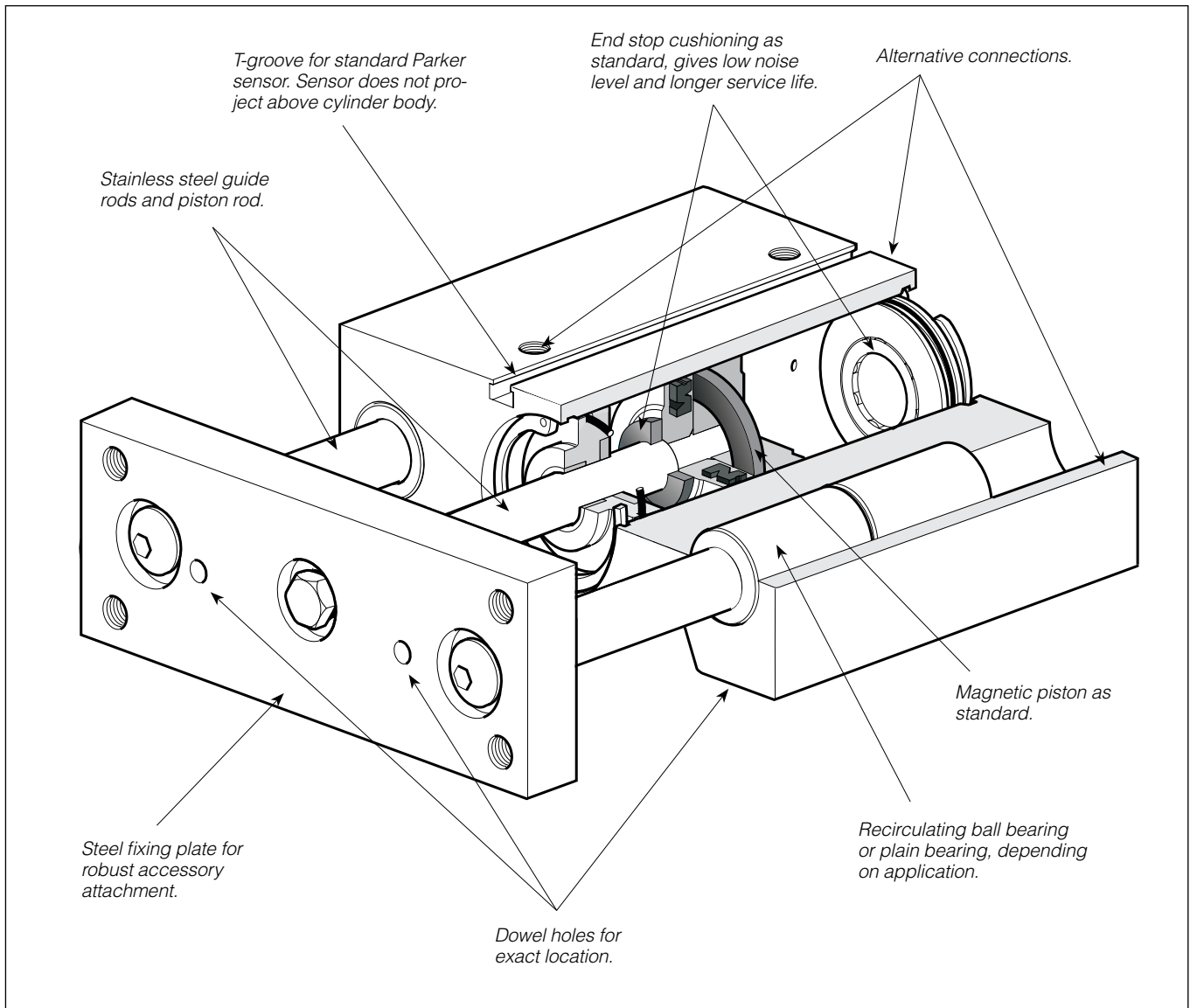

Short Stroke Thrusters

P5T cylinders are a modern and versatile range of cylinders with integral guides. The cylinders are double-acting, with end stop cushioning for quiet and vibration-free operation. They have strong shafts to prevent twisting, and everything is integrated into the cylinder housing.

The complete programme of cylinders comprises 9 cylinder diameters, Ø16 - Ø100 mm and strokes ranging from 10 to 200 mm. As with other Parker cylinders, the cylinder is initially lubricated with a white, non-poisonous grease which is approved for use in foodstuff preparation (USDA).

The strong guide shafts make it possible to absorb considerable thrust forces and torque. The cylinder is available with two different types of bearing in contact with the shaft, a recirculating ball bearing or plain bearing.

Multiple choice of connections is also a feature, one version has two connections at the rear or two connections from above, selectable by moving the enclosed plugs, and another version with two side connections is also available.

The P5T range has an integrated T-groove for sensors in the body. The T-groove makes it quick and easy to install non-contact sensors without increasing the installation dimensions of the cylinders.

The attachment plate and cylinder housing have dowel holes to give exact location during assembly. This also facilitates cylinder replacement.

The surface-treated steel fixing plate provides robust attachment.

Fixed end stop cushioning

Polyurethane end stop cushioning built in to the end covers is standard

Clean external design

The cylinder is designed without pockets or other cutouts in the body, in which dirt or fluids could collect. This makes cleaning both simple and easy.

Non-contact sensing

All cylinders are supplied with a magnetic piston as standard, for non-contact sensing. Electronic type sensors and reed switches are available. They are supplied with either flying lead or cable plug connector.

Options

In addition to the standard designs, a number of variants of the P5T range are available to special order, to provide effective solutions in a large number of applications.

Cylinders with special strokes

Cylinders with two fixing plates

Cylinders with adjustable stops, with cushioning

High-temperature cylinders for the temperature range of -10°C to +150°C (not magnetic piston).

Plain bearing or recirculating ball bearings

The P5T is supplied with plain bearings as standard. This type of bearing has guide rods of greater diameter, providing excellent support for heavy loads, especially static loads. Plain bearings are highly tolerant of vibration and dirt, and are suitable for regular cleaning.

Recirculating ball bearings are used for applications which require high precision and low friction.

The choice should be based on the following factors:

Application requirements	Plain bearing	Recirculating ball bearings
Precision	Good	Excellent
Friction	Higher	Low
Coefficient of friction	Variable	Constant
Precision during service life	Variable	Constant
Static load capacity	Excellent	Good
Dynamic load capacity	Good, but with friction losses	Good
Vibration tolerance	Excellent	Average
Dirt tolerance	Excellent	Poor
Washing tolerance	Excellent	Poor

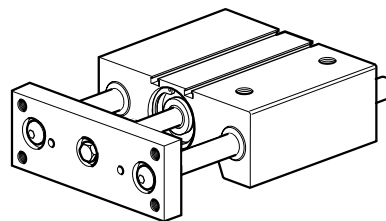

Double acting, connections on top.

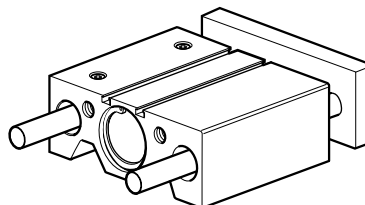

Double acting, connections at rear.

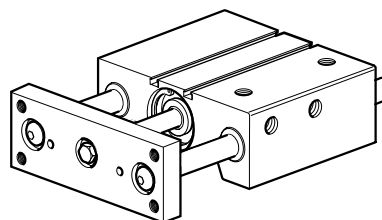

Double acting, connections on side.

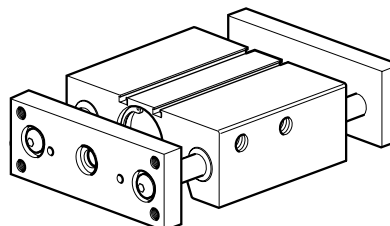

Double acting with two fixing plates, side connections are recommended.

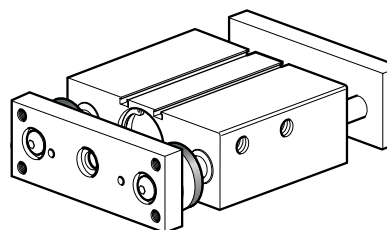

Double acting with two fixing plates and adjustable end stops with cushioning, side connections are recommended.

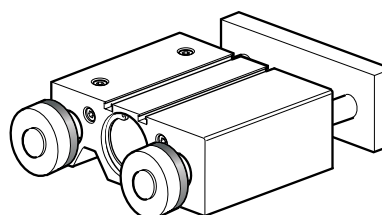

Double acting with one fixing plate adjustable end stops with cushioning, connections on side, on top or at rear.

P5T Short Stroke Thrusters**Cylinder forces, double acting variants**

Cyl. bore/ pist. rod mm	Stroke	Piston area cm ²	Max theoretical force in N (bar)									
			1,0	2,0	3,0	4,0	5,0	6,0	7,0	8,0	9,0	10,0
16/8	+	2,0	20	40	60	80	100	120	141	161	181	201
	-	1,5	15	30	45	60	75	90	106	121	136	151
20/10	+	3,1	31	63	94	126	157	188	220	251	283	314
	-	2,3	23	46	69	92	115	138	161	184	207	231
25/10	+	4,9	49	98	147	196	245	295	344	393	442	491
	-	4,1	41	82	124	165	206	247	289	330	371	412
32/16	+	7,9	79	158	237	316	394	473	552	631	710	789
	-	5,9	59	118	178	237	296	355	418	473	533	592
40/16	+	12,6	126	251	377	503	628	754	880	1005	1131	1257
	-	10,6	106	211	317	422	528	633	739	844	950	1056
50/20	+	19,6	196	393	589	785	982	1178	1374	1571	1767	1963
	-	16,5	165	330	495	660	825	990	1155	1319	1484	1649
63/20	+	31,2	312	623	935	1247	1559	1870	2182	2494	2806	3117
	-	28,0	280	561	841	1121	1402	1682	1962	2242	2523	2803
80/25	+	50,3	503	1005	1508	2011	2513	3016	3519	4021	4524	5027
	-	45,4	454	907	1361	1814	2268	2721	3175	3629	4082	4536
100/25	+	78,5	785	1571	2356	3142	3927	4712	5498	6283	7069	7854
	-	73,6	736	1473	2209	2945	3682	4418	5154	5890	6627	7363

+ = Outward stroke
- = Return stroke

Note!

Select a theoretical force 50-100%
larger than the force required

Working medium, air quality

Working medium

Dry, filtered compressed air
to ISO 8573-1 class 3.4.3.

Recommended air quality for cylinders

For best possible service life and trouble-free operation, ISO 8573-1 quality class 3.4.3 should be used. This means 5 µm filter (standard filter) dew point +3 °C for indoor operation (a lower dew point should be selected for outdoor operation) and oil concentration 1.0 mg oil/m³, which is what a standard compressor with a standard filter gives.

ISO 8573-1 quality classes

Quality class	Pollution		Water max. press. dew point (°C)	Oil max concentration (mg/m ³)
	particle size (µm)	max concentration (mg/m ³)		
1	0,1	0,1	-70	0,01
2	1	1	-40	0,1
3	5	5	-20	1,0
4	15	8	+3	5,0
5	40	10	+7	25
6	-	-	+10	-

P5T Short Stroke Thrusters

Main data: P5T

Cylinder designation	Cylinder		Piston rod		Theoretical cylinder thrust at 6 bar		Air consumption litre	Connection thread
	diam.	area	diam.	area	outward stroke	return stroke		
	mm	cm ²	mm	cm ²	N	N		
P5T-•016•G••XXX¹⁾	16	2,0	8	0,5	120	90	0,026	M5
P5T-•020•G••XXX¹⁾	20	3,1	10	0,8	188	138	0,040	G1/8
P5T-•025•G••XXX¹⁾	25	4,9	10	0,8	295	247	0,063	G1/8
P5T-•032•G••XXX¹⁾	32	8,0	16	2,0	482	363	0,105	G1/8
P5T-•040•G••XXX¹⁾	40	12,6	16	2,0	754	633	0,162	G1/8
P5T-•050•G••XXX¹⁾	50	19,6	20	3,1	1178	990	0,253	G1/4
P5T-•063•G••XXX¹⁾	63	31,2	20	3,1	1870	1682	0,414	G1/4
P5T-•080•G••XXX¹⁾	80	50,3	25	4,9	3016	2721	0,669	G3/8
P5T-•100•G••XXX¹⁾	100	78,5	25	4,9	4712	4418	1,043	G3/8

1) XXX = stroke

• = option, as in ordering key

2) Free air consumption for 10 mm stroke for a double stroke at 6 bar.

Weights in kg

Cylinder diam. mm	Type of bearing	Shaft diam. mm	Standard stroke											
			10	25	40	50	75	100	125	150	175	200		
16	Plain bearing	10	0,35	0,43	0,51	0,57	0,70	0,84						
	Recirculating ball	8	0,32	0,39	0,46	0,51	0,64	0,76						
20	Plain bearing	12		0,76	0,86	0,94	1,11	1,29	1,47					
	Recirculating ball	10		0,70	0,80	0,86	1,03	1,19	1,36					
25	Plain bearing	16		1,13		1,39	1,65	1,91	2,17	2,43				
	Recirculating ball	12		0,98		1,20	1,43	1,65	1,88	2,11				
32	Plain bearing	20		1,67		2,07	2,46	2,86	3,26	3,65	4,05	4,45		
	Recirculating ball	16		1,51		1,86	2,21	2,56	2,91	3,27	3,62	3,97		
40	Plain bearing	20		2,00		2,42	2,84	3,26	3,68	4,10	4,52	4,84		
	Recirculating ball	16		1,82		2,20	2,57	2,95	3,32	3,70	4,08	4,45		
50	Plain bearing	25		2,63		3,22	3,81	4,40	4,99	5,59	6,18	6,77		
	Recirculating ball	20		2,35		2,87	3,39	3,92	4,44	4,96	5,48	6,01		
63	Plain bearing	25		3,29		3,98	4,66	5,34	6,02	6,71	7,39	8,07		
	Recirculating ball	20		2,99		3,60	4,22	4,83	5,45	6,06	6,67	7,29		
80	Plain bearing	30		6,06		7,12	8,18	9,24	10,30	11,36	12,42	13,48		
	Recirculating ball	25		5,66		6,63	7,61	8,58	9,56	10,53	11,51	12,49		
100	Plain bearing	35		10,69		12,03	13,37	14,71	16,05	17,39	18,73	20,08		
	Recirculating ball	30		10,16		11,40	12,64	13,89	15,13	16,37	17,61	18,85		

Material specification

Standard specification

Body	Natural anodised aluminium
End pieces	Black anodised aluminium
Piston rod	Stainless steel (SS 2346)
Guide rods	Stainless steel (SS 2346)
Plain bearing	PTFE / Steel
Ball bushing	Steel
Plate	Surface treated steel
Screws	Surface treated steel
Piston	Natural anodised aluminium
Magnetic ring	Rubber-bound magnetic material
Cushioning rings	Polyurethane
Piston seal	Nitrile rubber, NBR
O-rings	Nitrile rubber, NBR
Piston bearing	UHMWPE plastic

Material specification

High temperature option

Seals	Fluorocarbon rubber, FPM
Piston bearing	Bronze filled PTFE

Other data

Working medium	Dry, filtered air
Working pressure	max. 10 bar
Working temperature	max +80 °C min -20 °C
High temp. option	max +150 °C min -10 °C

Guide for selecting suitable tubing

The selection of the correct size of tubing is often based on experience, with no great thought to optimizing energy efficiency and cylinder velocity. This is usually acceptable, but making a rough calculation can result in worthwhile economic gains.

The following is the basic principle:

1. The primary line to the working valve could be over sized (this does not cause any extra air consumption and consequently does not create any extra costs in operation).
2. The tubes between the valve and the cylinder should, however, be optimized according to the principle that an insufficient bore throttles the flow and thus limits the cylinder speed, while an oversized pipe creates a dead volume which increases the air consumption and filling time.

The chart below is intended to help when selecting the correct size of tube to use between the valve and the cylinder.

The following prerequisites apply:

The cylinder load should be about 50% of the theoretical force (= normal load). A lower load gives a higher velocity and vice versa. The tube size is selected as a function of the cylinder bore, the desired cylinder velocity and the tube length between the valve and the cylinder.

If you want to use the capacity of the valve to its maximum, and obtain maximum speed, the tubing should be chosen so that they at least correspond with the equivalent restriction diameter (see description below), so that the tubing does not restrict the total flow. This means that a short tubing must have at least the equivalent restriction diameter. If the tubing is longer, choose it from the table below. Straight fittings should be chosen for highest flow rates. (Elbow and banjo fittings cause restriction.)

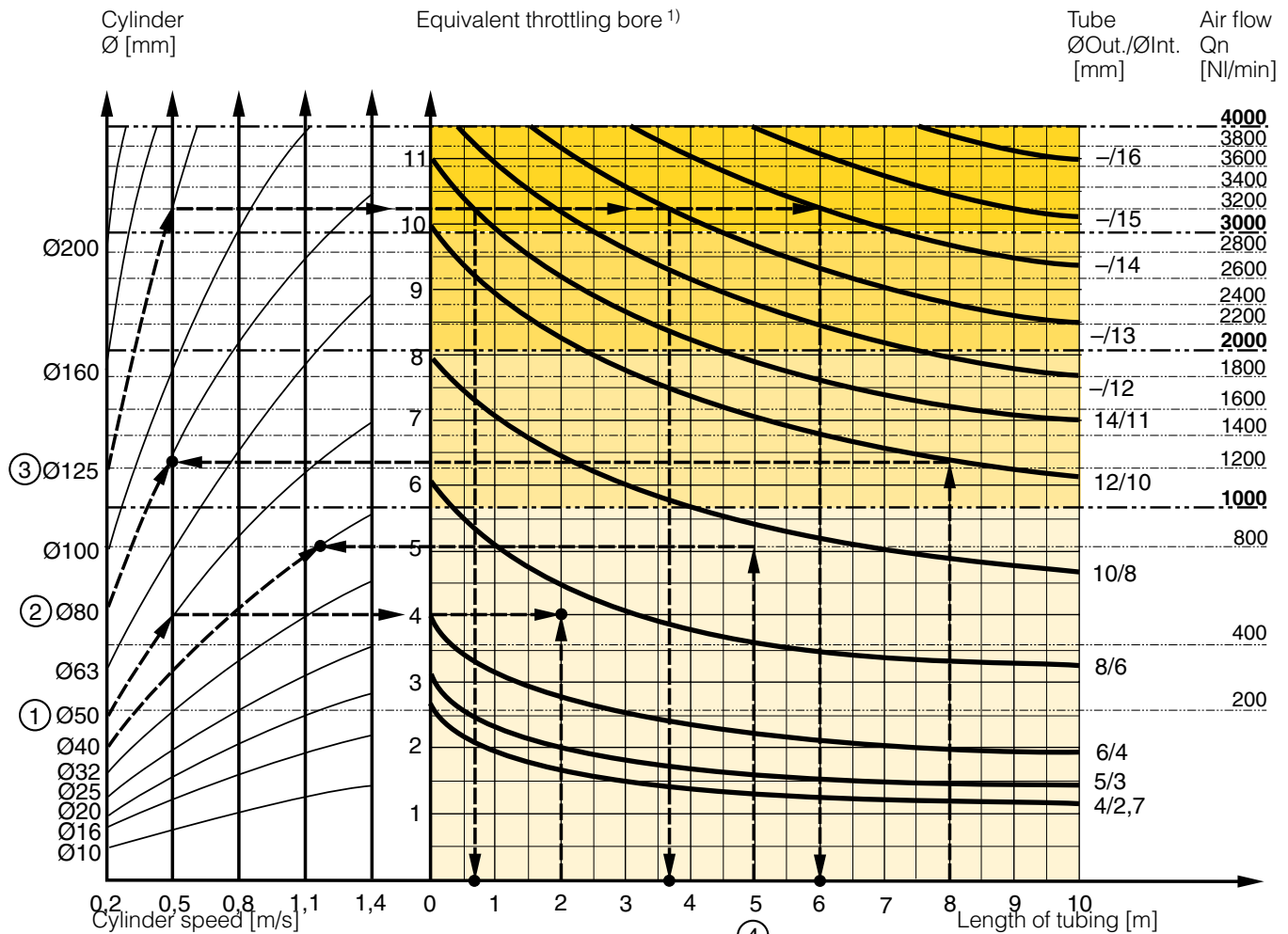

- 1) The "equivalent throttling bore" is a long throttle (for example a tube) or a series of throttles (for example, through a valve) converted to a short throttle which gives a corresponding flow rate. This should not be confused with the "orifice" which is sometimes specified for valves. The value for the orifice does not normally take account of the fact that the valve contains a number of throttles.
- 2) Qn is a measure of the valve flow capacity, with flow measured in litre per minute (l/min) at 6 bar(e) supply pressure and 1 bar pressure drop across the valve.

P5T Short Stroke Thrusters

Example ①: Which tube diameter should be used?

A 50 mm bore cylinder is to be operated at 0.5 m/s. The tube length between the valve and cylinder is 2 m. In the diagram we follow the line from 50 mm bore to 0.5 m/s and get an "equivalent throttling bore" of approximately 4 mm. We continue out to the right in the chart and intersect the line for a 2 m tube between the curves for 4 mm (6/4 tube) and 6 mm (8/6 tube). This means that a 6/4 tube throttles the velocity somewhat, while an 8/6 tube is a little too large. We select the 8/6 tube to obtain full cylinder velocity.

Example ②: What cylinder velocity will be obtained?

A 80 mm bore cylinder will be used, connected by 8 m 12/10 tube to a P2L-B valve. What cylinder velocity will we get? We refer to the diagram and follow the line from 8 mm tube length up to the curve for 12/10 tube. From there, we go horizontally to the curve for the Ø80 cylinder. We find that the velocity will be about 0.5 m/s.

Example ③: What is the minimum inner diameter and maximum length of tube?

For an application a 125 mm bore cylinder will be used. Maximum velocity of piston rod is 0.5 m/s. The cylinder will be controlled by a P2L-D valve. What diameter of tube can be used and what is maximum length of tube. We refer to the diagram. We start at the left side of the diagram cylinder Ø125. We follow the line until the intersection with the velocity line of 0.5 m/s. From here we draw a horizontal line in the diagram. This line shows us we need an equivalent throttling bore of approximately 10 mm. Following this line horizontally we cross a few intersections. These intersections shows us the minimum inner diameter (rightside diagram) in combination with the maximum length of tube (bottomside diagram).

For example:

Intersection one: When a tube (14/11) will be used, the maximum length of tube is 0.7 meter.

Intersection two: When a tube (—/13) will be used, the maximum length of tube is 3.7 meter.

Intersection three: When a tube (—/14) will be used, the maximum length of tube is 6 meter.

Example ④: Determining tube size and cylinder velocity with a particular cylinder and valve?

For an application using a 40 mm bore cylinder with a valve with $Q_n=800$ NI/min. The distance between the cylinder and valve has been set to 5 m.

Tube dimension: What tube bore should be selected to obtain the maximum cylinder velocity? Start at pipe length 5 m, follow the line up to the intersection with 800 NI/min. Select the next largest tube diameter, in this case Ø10/8 mm.

Cylinder velocity: What maximum cylinder velocity will be obtained? Follow the line for 800 NI/min to the left until it intersects with the line for the Ø40 mm cylinder. In this example, the speed is just above 1.1 m/s.

Valve series with respective flows in NI/minute

Valve series	Qn in NI/Min
Valvetronic Solstar	33
Interface PS1	100
Adex A05	173
Moduflex size 1, (2 x 3/2)	220
Valvetronic PVL-B 5/3 closed centre, 6 mm push in	290
Moduflex size 1, (4/2)	320
B43 Manual and mechanical	340
Valvetronic PVL-B 2 x 2/3, 6 mm push in	350
Valvetronic PVL-B 5/3 closed centre, G1/8	370
Compact Isomax DX02	385
Valvetronic PVL-B 2 x 3/2 G1/8	440
Valvetronic PVL-B 5/2, 6 mm push in	450
Valvetronic PVL-B 5/3 vented centre, 6 mm push in	450
Moduflex size 2, (2 x 3/2)	450
Flowstar P2V-A	520
Valvetronic PVL-B 5/3 vented centre, G1/8	540
Valvetronic PVL-B 5/2, G1/8	540
Valvetronic PVL-C 2 x 3/2, 8 mm push in	540
Adex A12	560
Valvetronic PVL-C 2 x 3/2 G1/8	570
Compact Isomax DX01	585
VIKING Xtreme P2LAX	660
Valvetronic PVL-C 5/3 closed centre, 8 mm push in	700
Valvetronic PVL-C 5/3 vented centre, G1/4	700
B3-Series	780
Valvetronic PVL-C 5/3 closed centre, G1/4	780
Moduflex size 2, (4/2)	800
Valvetronic PVL-C 5/2, 8 mm push in	840
Valvetronic PVL-C 5/3 vented centre, 8 mm push in	840
Valvetronic PVL-C 5/2, G1/4	840
Flowstar P2V-B	1090
ISOMAX DX1	1150
B53 Manual and mechanical	1160
B4-Series	1170
VIKING Xtreme P2LBX	1290
B5-Series, G1/4	1440
Airline Isolator Valve VE22/23	1470
ISOMAX DX2	2330
VIKING Xtreme P2LCX, G3/8	2460
VIKING Xtreme P2LDX, G1/2	2660
ISOMAX DX3	4050
Airline Isolator Valve VE42/43	5520
Airline Isolator Valve VE82/83	13680

P5T Short Stroke Thrusters

Dimensions, P5T basic cylinder

Connection option **D**
(connection from above or rear)

CAD drawings on the Internet

Our home page www.parker.com/euro_pneumatic includes the AirCad Drawing. Library with 2D and 3D drawings for the main versions.

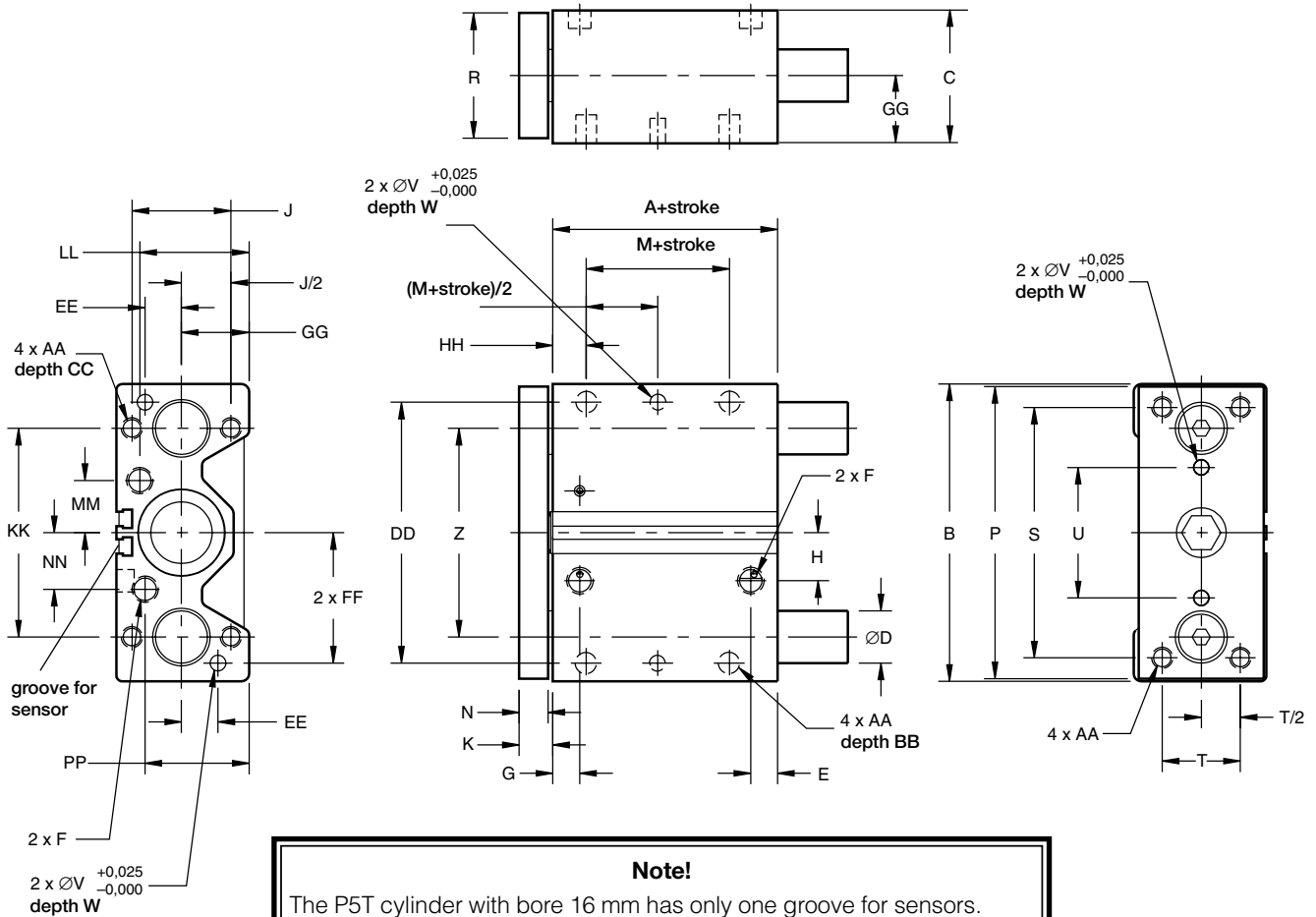

Note!

The P5T cylinder with bore 16 mm has only one groove for sensors. When 2 sensors are used for stroke 25 mm or shorter, sensors with 90 degree cable outlet has to be used, see page 23.

Cylinder diam. mm	A mm	B mm	C mm	D1*) mm	D2*) mm	E mm	F	G mm	H mm	J mm	K mm	M mm	N mm	P mm	R mm	S mm	T mm	U mm	V mm
16	37,8	64	31	8	10	10,1	M5	10,1	7	22	9,9	7	7,9	62	25,4	52	16	20	3
20	35	74	36	10	12	19	G1/8	10	15,8	26	9,9	10	7,9	72	31,8	60	18	30	4
25	38	88	42	12	16	21	G1/8	11,4	15,5	32	9,9	10	7,9	86	38	70	26	34	4
32	36	114	51	16	20	10,3	G1/8	10,4	18,4	38	13,1	5	11,1	112	44,5	96	30	50	6
40	44	124	51	16	20	12,1	G1/8	14,9	22,5	38	13,1	10	11,1	122	44	106	30	60	6
50	44,9	140	62	20	25	14,5	G1/4	16,1	27	44	14,7	10	12,7	138	57	120	40	60	8
63	50,1	150	75	20	25	16,4	G1/4	14,5	33	44	14,7	10	12,7	148	70	130	50	72	8
80	59,5	188	95	25	30	17,5	G3/8	19	37	56	18	15	16	185	88,9	160	60	92	10
100	66**)	224	115	30	35	21,9**)	G3/8	23	40	62	18	15	16	221	108	190	80	114	10

Cylinder diam. mm	W mm	Z mm	AA	BB mm	CC mm	DD mm	EE mm	FF mm	GG mm	HH mm	KK mm	LL mm	MM mm	NN mm	PP mm	Piston rod Ø mm
16	6	42	M5x0,8	7,5	10	54	8	27	15	13,1	42	22,5	11,3	9,7	23	8
20	6	52	M5x0,8	7,5	10	64	10	32	17	13,1	52	26	15,4	15,4	26	10
25	6	62	M6x1,0	10	12	76	11	38	21	14,1	62	33,4	17	17	33,4	10
32	6	80	M8x1,25	11	16	100	14	50	26	12,9	80	42	20	21,7	38	16
40	6	90	M8x1,25	11	16	110	14	55	26	13,9	90	41	24	26,4	37,9	16
50	8	100	M10x1,5	12	20	124	16	62	30	14,3	100	51	29	33	44	20
63	8	110	M10x1,5	15	20	132	18	66	36,5	16,3	110	62	36	37,8	57,8	20
80	10	140	M12x1,75	18	24	166	22	83	46,5	21	140	78	45	48	75,5	25
100	10	170	M14x2,0	21	28	200	24	100	56,5	25	170	91,5	53	51	95,5	25

Length tolerance ± 1 mm

Stroke tolerance + 1.5/0 mm

***) Stroke 25 mm, A=75 mm, E=28 mm

*) D1 = bearing rod diameter for recirculating ball bearing

*) D2 = bearing rod diameter for plain bearing



P5T Short Stroke Thrusters

Dimensions, P5T basic cylinder

Standard lengths

Cylinder diam mm	Stroke mm	L mm
16	10	36,2
	25, 40, 50, 75	60,2
	100	75,2
20	25, 40, 50, 75	66,9
	100, 125	91,9
25	25, 50, 75, 100	69,9
	125, 150	91,9
32	25, 50, 75, 100	77,9
	125, 150, 175, 200	116,0
40	25, 50, 75, 100	77,9
	125, 150, 175, 200	116,0
50	25, 50, 75, 100	84,0
	125, 150, 175, 200	124,1
63	25, 50, 75, 100	84,0
	125, 150, 175, 200	124,1
80	25, 50, 75, 100	101,8
	125, 150, 175, 200	140,0
100	25	122,8
	50, 75, 100	120,3
	125, 150, 175, 200	158,4

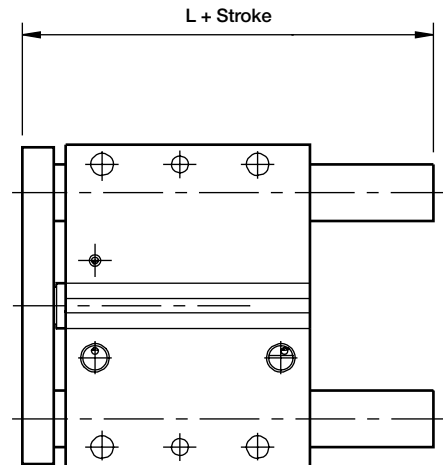

Dimensions, P5T basic cylinder

Connection option **S** (side connections)

Cylinder diam. mm	SS mm	TT mm	UU mm	F
16	24,1	10	20	M5
20	29,2	10	20	M5
25	35,2	11,4	25	M5
32	41,7	10,4	34	G1/8
40	41,7	14,9	34	G1/8
50	51,3	16,1	38	G1/4
63	60,7	15,6	41,8	G1/4
80	75,5	19	47	G3/8
100	83,7	23	53,3	G3/8

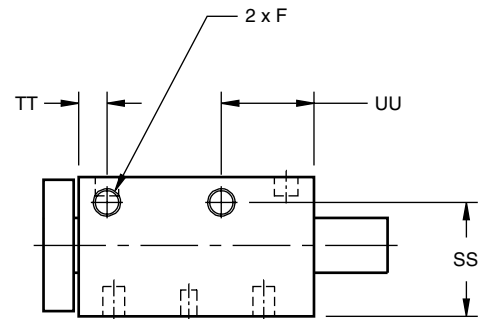

P5T Short Stroke Thrusters

Dimensions, P5T basic cylinder

Option **D**

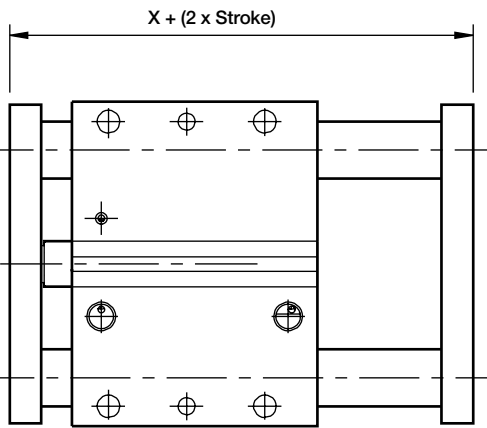

Please note that load capacity increases with two fixing plates, due to greater bearing distance.

Dimensions, P5T with two fixing plates and adjustable end stop with cushioning (outward stroke)

Option **A**

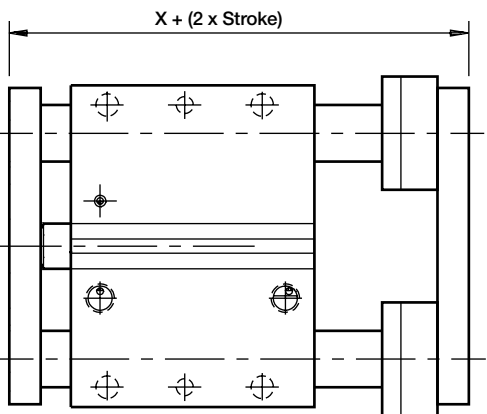

Cylinder diam. mm	Guide rod dia, mm	X for option			QQ mm	RR mm	XX mm
		D mm	A mm	E mm			
16	8	57,6	70,6	62,7	18,0	13,0	0
	10	57,6	70,6	62,7	24,0	13,0	1
20	10	54,9	67,9	59,9	24,0	13,0	1
	12	54,9	72,6	64,6	28,0	17,7	3
25	12	57,8	75,5	67,6	28,0	17,7	1
	16	57,8	77,5	69,6	34,0	19,7	4
32	16	62,2	81,9	70,8	34,0	19,7	0
	20	62,2	83,9	72,8	41,4	21,7	3,7
40	16	70,2	89,9	78,8	34,0	19,7	0
	20	70,2	91,9	80,8	41,4	21,7	3,7
50	20	74,3	96,0	83,3	41,4	21,7	0,7
	25	74,3	96,0	83,3	50,8	21,7	5,4
63	20	79,5	101,2	88,5	41,4	21,7	0,7
	25	79,5	101,2	88,5	50,8	21,7	5,4
80	25	95,5	117,2	101,2	50,8	21,7	1,4
	30	95,5	117,2	101,2	60,5	21,7	6,3
100	30	102,0	123,7	107,7	60,5	21,7	3,3
	35	102,0	123,7	107,7	65,0	21,7	5,5

Dimensions, P5T with adjustable end stop with cushioning (outward stroke)

Option **E**

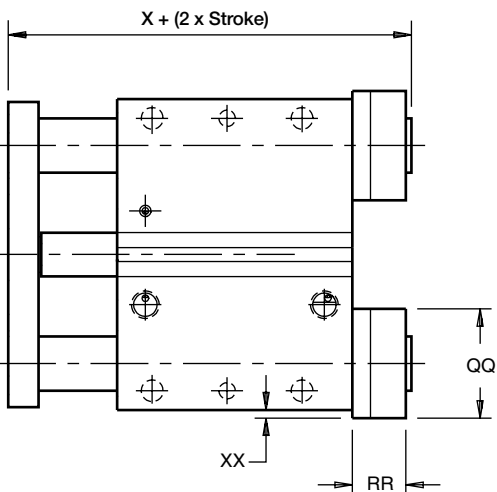

P5T Short Stroke Thrusters

Maximum load

P5T cylinders can absorb the same load, irrespective of how it is installed. The loading diagram is based on a service life for the cylinder of at least 10 million cycles. At higher loadings, the service life will be reduced.

Example

Estimate the load limit for a P5T-16 with plain bearing and stroke + d = 75 mm has load capacity 50 N.

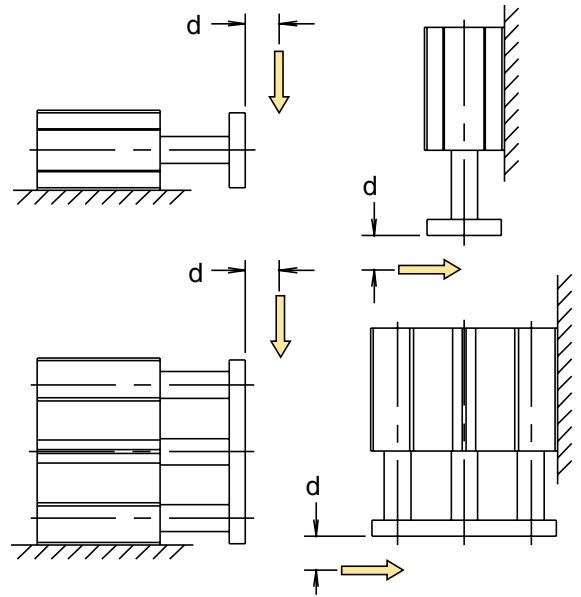

Load capacity as a function of Stroke + d

Cylinder bore 16 mm

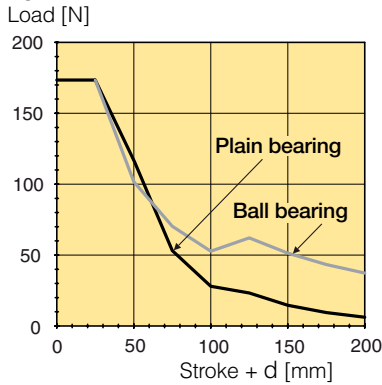

Cylinder bore 20 mm

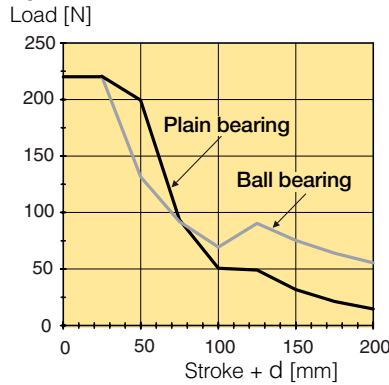

Cylinder bore 25 mm

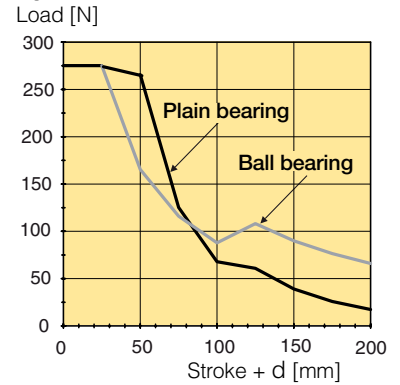

Cylinder bore 32 mm

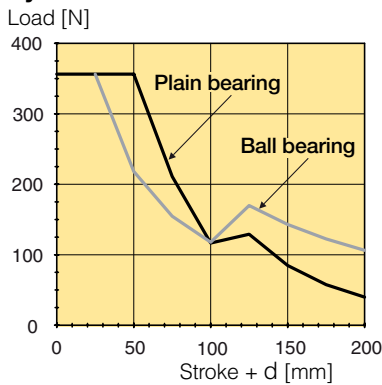

Cylinder bore 40 mm

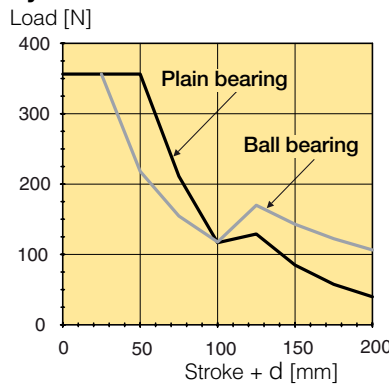

Cylinder bore 50 mm

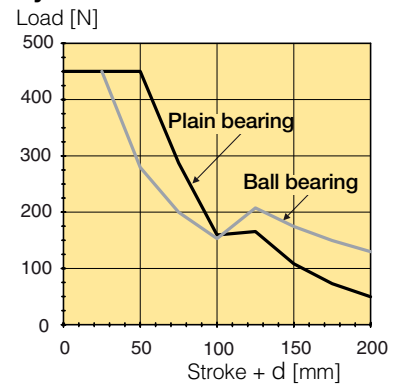

Cylinder bore 63 mm

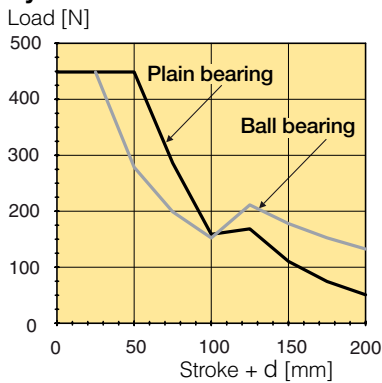

Cylinder bore 80 mm

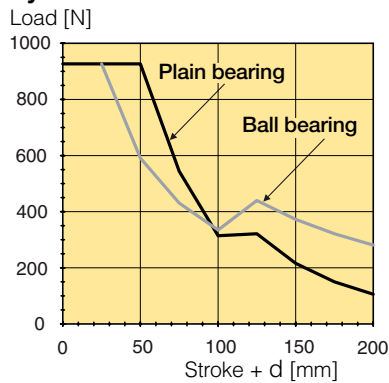

Cylinder bore 100 mm

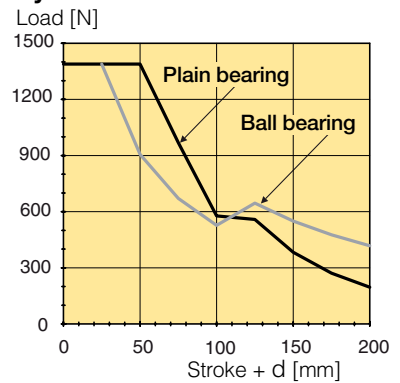

P5T Short Stroke Thrusters

Maximum Torsional Capacity for Symmetrical Torsion

When symmetrical loads are applied, P5T Series load ratings are greater than with asymmetrical loads because both pairs of shaft bearings equally resist the load.

Example:

A wrist rotate mechanism symmetrically grabs and rotates a part. The mechanism exerts a 20 Nm torque on a P5T-50 with 25mm stroke. The center of gravity for the wrist rotate mechanism is 25mm from the face of the P5T-50.

The "stroke + d" dimension equals 50mm (25 + 25). The P5T-50 with plain bearing will have adequate torsional capacity (22.5 Nm).

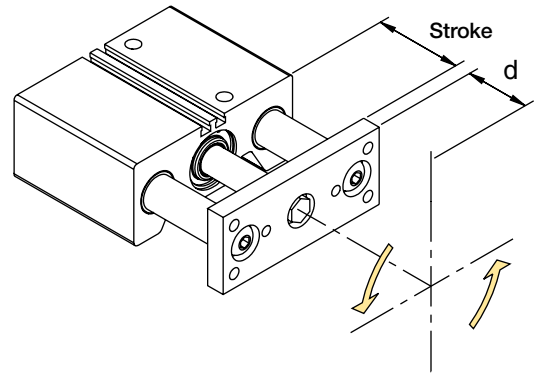

Maximum torque as a function of Stroke + d

Cylinder bore 16 mm

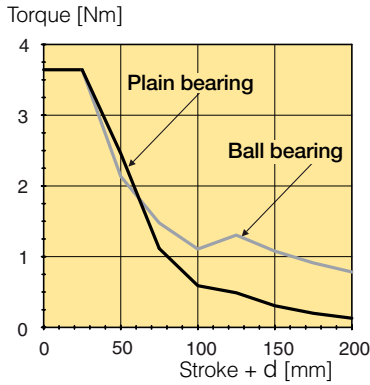

Cylinder bore 20 mm

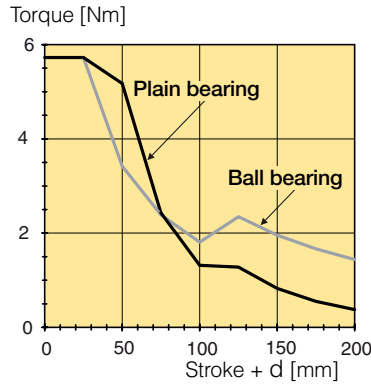

Cylinder bore 25 mm

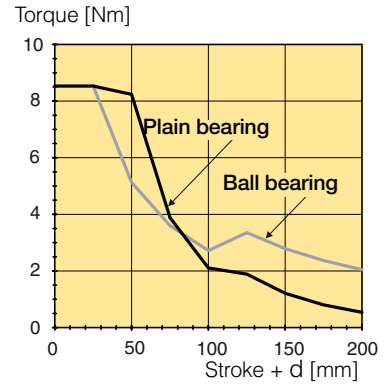

Cylinder bore 32 mm

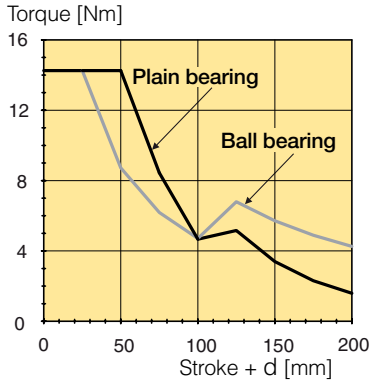

Cylinder bore 40 mm

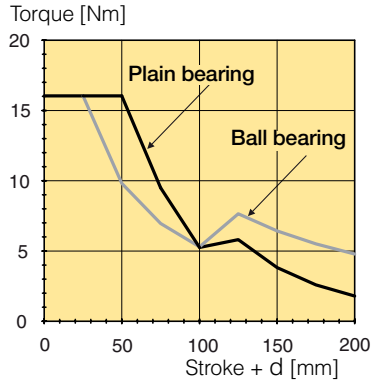

Cylinder bore 50 mm

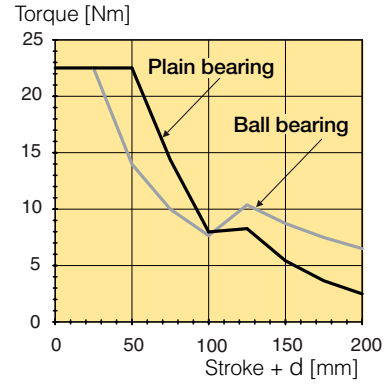

Cylinder bore 63 mm

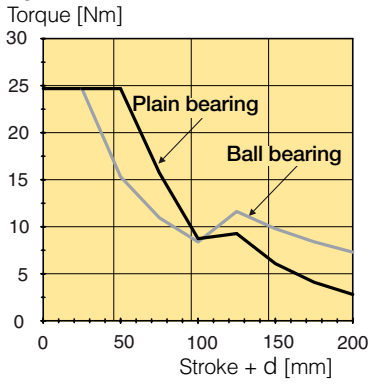

Cylinder bore 80 mm

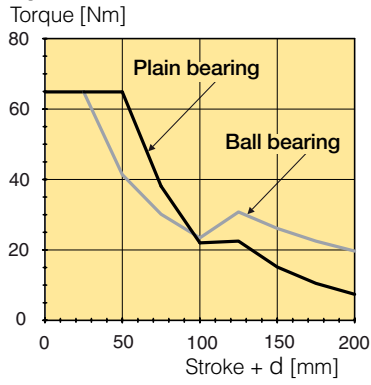

Cylinder bore 100 mm

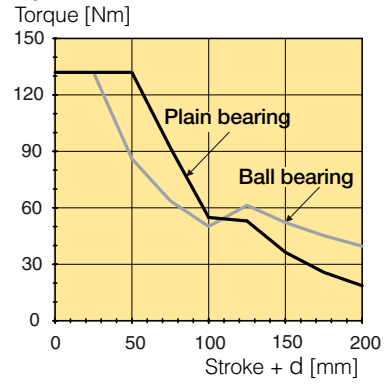

Maximum Torsional Capacity for Asymmetrical Torque

Asymmetrical loading occurs when the load is applied to one side of the unit. P5T Series units can resist torsional loads that are asymmetrical according to the diagrams below.

Example:

A mechanism exerts an asymmetrical load of 15 Nm on a P5T-50 with 30 mm stroke. The centre of asymmetric torque $d = 20$ mm. Stroke + d ($30+20$) = 50 mm. The P5T-50 with plain bearing will have adequate torsional capacity (21 Nm).

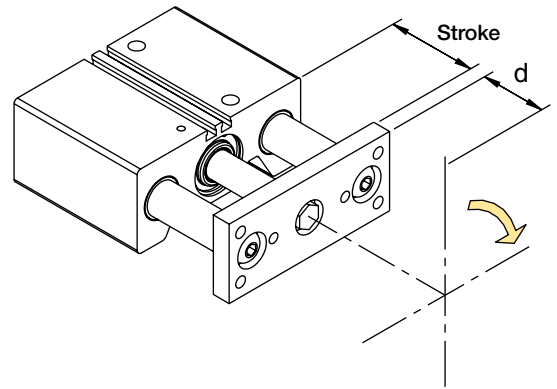

Maximum torque as a function of Stroke + d

Cylinder bore 16 mm

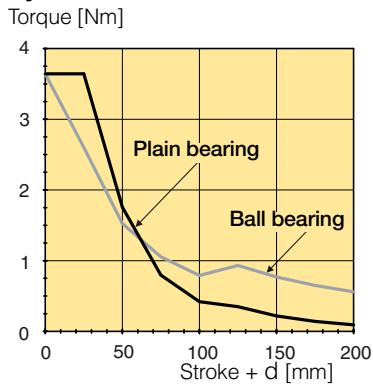

Cylinder bore 20 mm

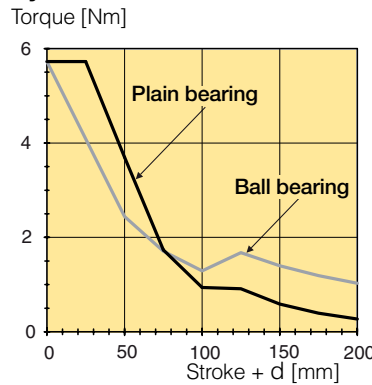

Cylinder bore 25 mm

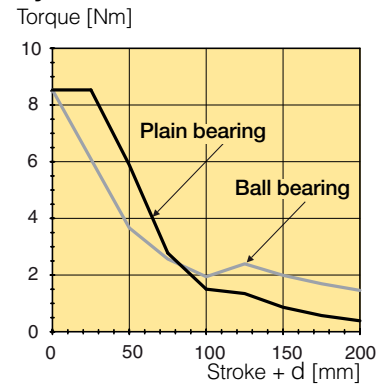

Cylinder bore 32 mm

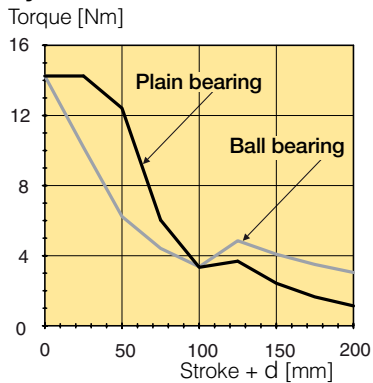

Cylinder bore 40 mm

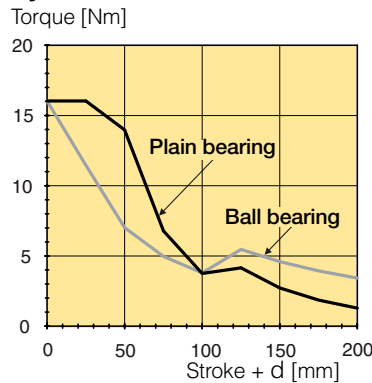

Cylinder bore 50 mm

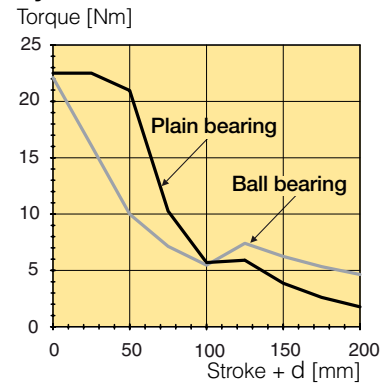

Cylinder bore 63 mm

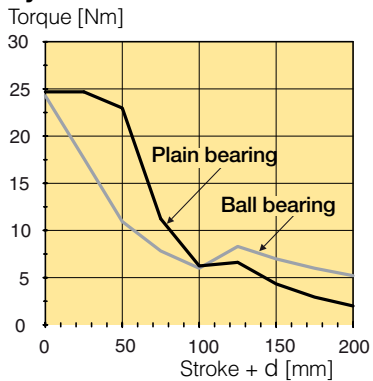

Cylinder bore 80 mm

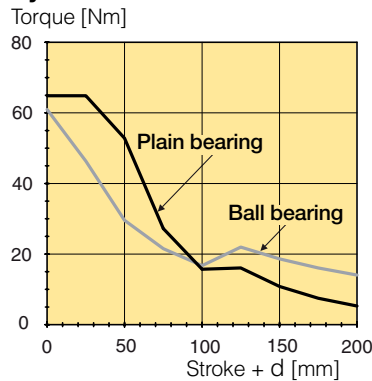

Cylinder bore 100 mm

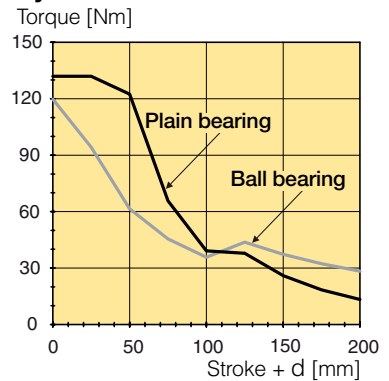

Maximum load during vertical lift

The P5T cylinder has the capacity to absorb eccentric load-ings irrespective of location.
The load is assumed to be placed directly on the plate.

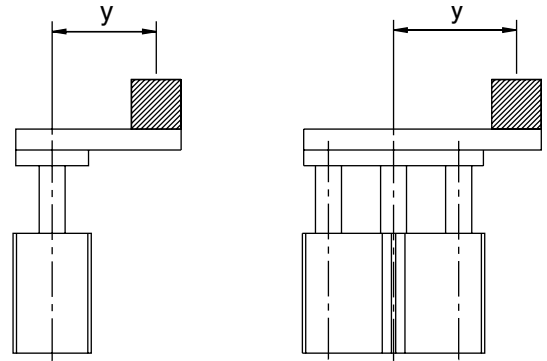

Maximum vertical load as a function of eccentricity

Cylinder bore 16 mm

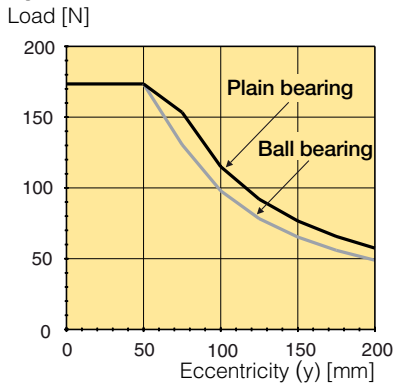

Cylinder bore 20 mm

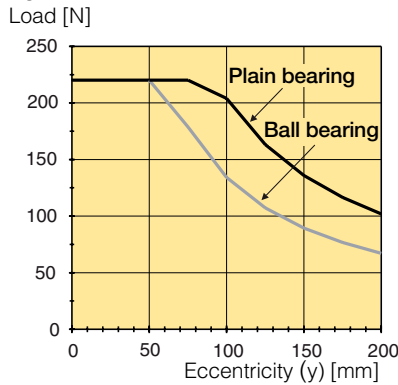

Cylinder bore 25 mm

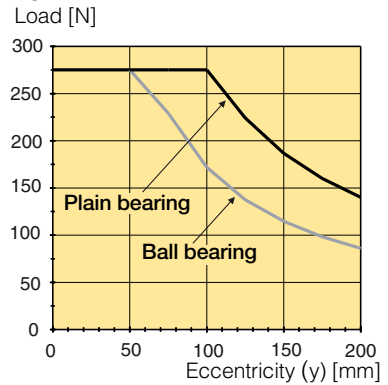

Cylinder bore 32 mm

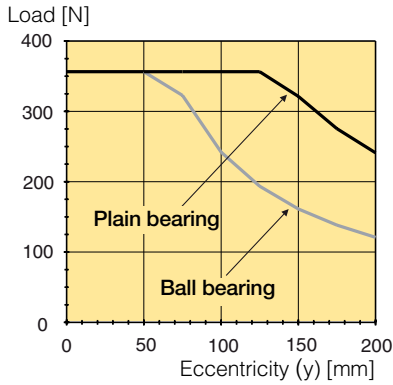

Cylinder bore 40 mm

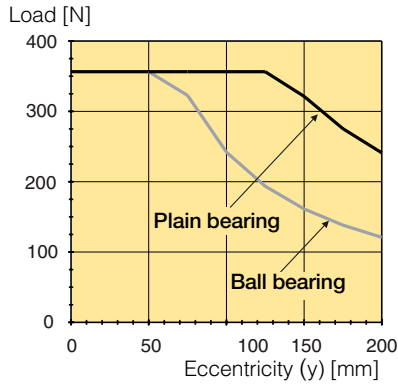

Cylinder bore 50 mm

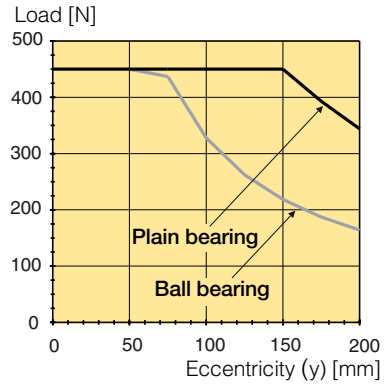

Cylinder bore 63 mm

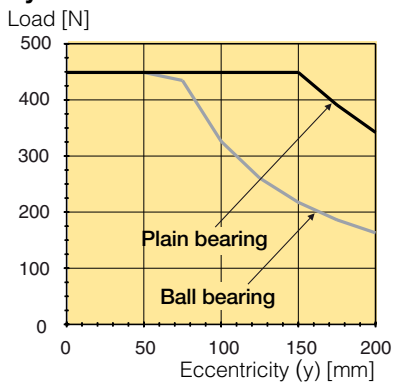

Cylinder bore 80 mm

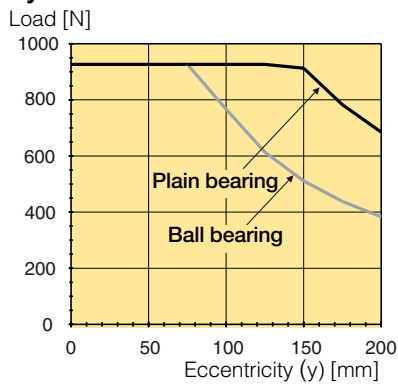

Cylinder bore 100 mm

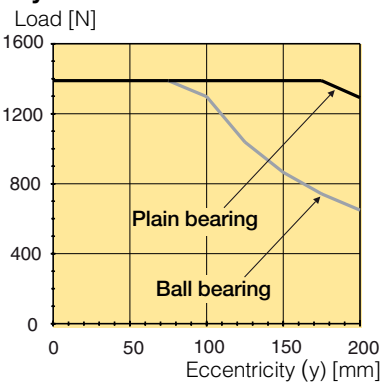

Maximum loading as a stop cylinder

The P5T cylinder can be used as a stop cylinder. It can be used both horizontally and vertically.

NOTE! Cylinders with plain bearings are recommended for this type of application.

Example:

A P5T-50 unit with a stroke up to 50 mm will stop an object moving at 0.5 m/s that weighs up to 50 kg.

NOTE: The following graphs are based on 50mm of stroke.

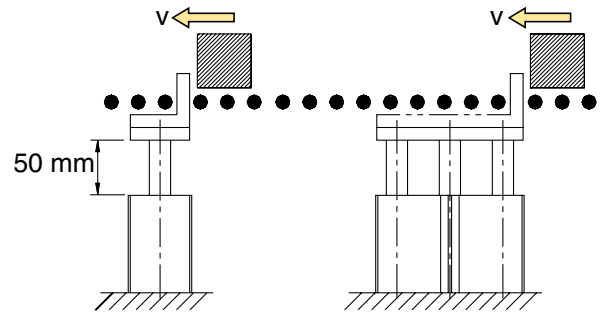

Load stopping capacity as a function of speed

Cylinder bore 16 mm

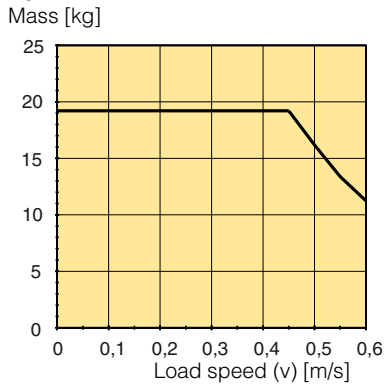

Cylinder bore 20 mm

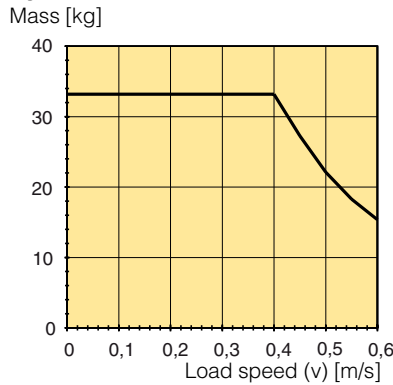

Cylinder bore 25 mm

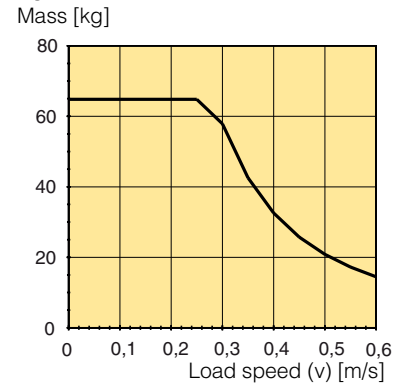

Cylinder bore 32 mm

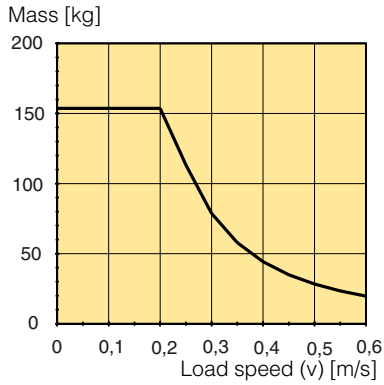

Cylinder bore 40 mm

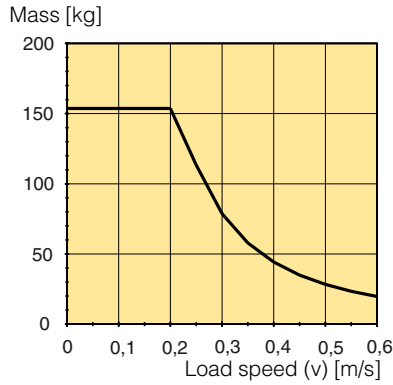

Cylinder bore 50 mm

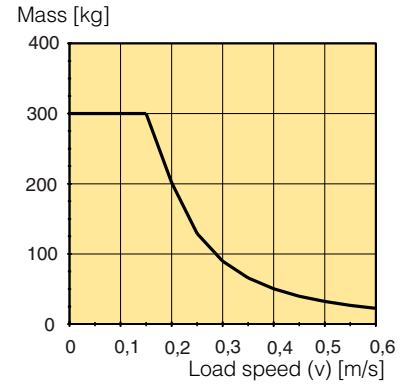

Cylinder bore 63 mm

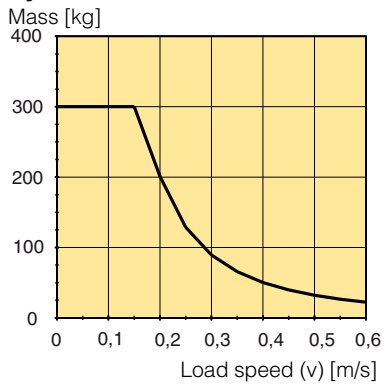

Cylinder bore 80 mm

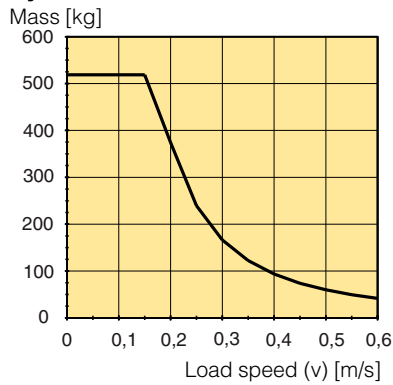

Cylinder bore 100 mm

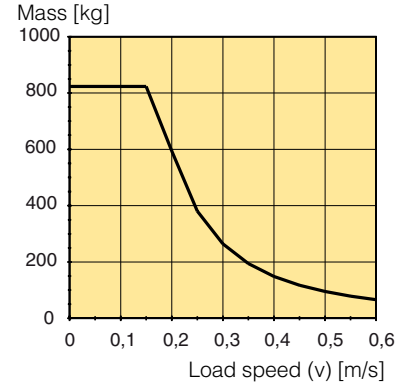

P5T Short Stroke Thrusters

Ordering key

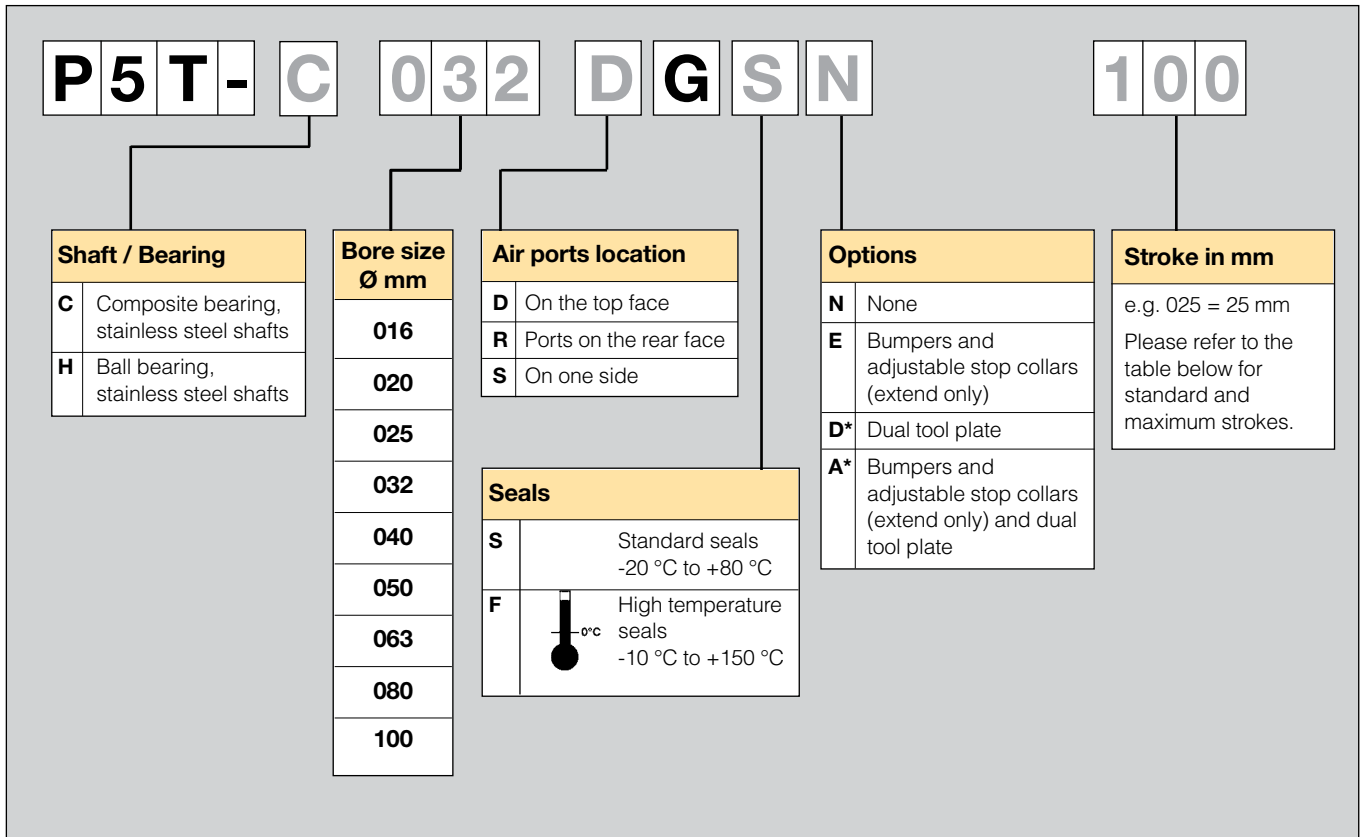

* Please note that the load capacity increases for the versions with two fixing plates, due to greater bearing distance.

Standard strokes

Order no. XXX = Stroke	Cylinder diam. (mm)	● Standard stroke (mm)									
		10	25	40	50	75	100	125	150	175	200
Double acting											
P5T-016-G-XXX	16	●	●	●	●	●	●				
P5T-020-G-XXX	20		●	●	●	●	●	●			
P5T-025-G-XXX	25		●	●	●	●	●	●	●		
P5T-032-G-XXX	32		●	●	●	●	●	●	●	●	
P5T-040-G-XXX	40		●	●	●	●	●	●	●	●	●
P5T-050-G-XXX	50		●	●	●	●	●	●	●	●	●
P5T-063-G-XXX	63		●	●	●	●	●	●	●	●	●
P5T-080-G-XXX	80		●	●	●	●	●	●	●	●	●
P5T-100-G-XXX	100		●	●	●	●	●	●	●	●	●

For cylinders with special stroke lengths, use the next longest standard stroke length with adjustable stop, option E.

P5T Short Stroke Thrusters

**Short Stroke Thrusters with plain bearing,
stainless steel shafts,
standard temperature range,
BSPP air ports on the top**



Cyl. bore mm	Stroke mm	Order code
16 M5 thread	10	P5T-C016DGSN010
	25	P5T-C016DGSN025
	40	P5T-C016DGSN040
	50	P5T-C016DGSN050
	75	P5T-C016DGSN075
	100	P5T-C016DGSN100
20 G1/8 thread	25	P5T-C020DGSN025
	40	P5T-C020DGSN040
	50	P5T-C020DGSN050
	75	P5T-C020DGSN075
	100	P5T-C020DGSN100
	125	P5T-C020DGSN125
25 G1/8 thread	25	P5T-C025DGSN025
	50	P5T-C025DGSN050
	75	P5T-C025DGSN075
	100	P5T-C025DGSN100
	125	P5T-C025DGSN125
	150	P5T-C025DGSN150
32 G1/8 thread	25	P5T-C032DGSN025
	50	P5T-C032DGSN050
	75	P5T-C032DGSN075
	100	P5T-C032DGSN100
	125	P5T-C032DGSN125
	150	P5T-C032DGSN150
	175	P5T-C032DGSN175
	200	P5T-C032DGSN200
40 G1/8 thread	25	P5T-C040DGSN025
	50	P5T-C040DGSN050
	75	P5T-C040DGSN075
	100	P5T-C040DGSN100
	125	P5T-C040DGSN125
	150	P5T-C040DGSN150
	175	P5T-C040DGSN175
	200	P5T-C040DGSN200

Cyl. bore mm	Stroke mm	Order code
50 G1/4 thread	25	P5T-C050DGSN025
	50	P5T-C050DGSN050
	75	P5T-C050DGSN075
	100	P5T-C050DGSN100
	125	P5T-C050DGSN125
	150	P5T-C050DGSN150
	175	P5T-C050DGSN175
	200	P5T-C050DGSN200
63 G1/4 thread	25	P5T-C063DGSN025
	50	P5T-C063DGSN050
	75	P5T-C063DGSN075
	100	P5T-C063DGSN100
	125	P5T-C063DGSN125
	150	P5T-C063DGSN150
	175	P5T-C063DGSN175
	200	P5T-C063DGSN200
80 G3/8 thread	25	P5T-C080DGSN025
	50	P5T-C080DGSN050
	75	P5T-C080DGSN075
	100	P5T-C080DGSN100
	125	P5T-C080DGSN125
	150	P5T-C080DGSN150
	175	P5T-C080DGSN175
	200	P5T-C080DGSN200
100 G3/8 thread	25	P5T-C100DGSN025
	50	P5T-C100DGSN050
	75	P5T-C100DGSN075
	100	P5T-C100DGSN100
	125	P5T-C100DGSN125
	150	P5T-C100DGSN150
	175	P5T-C100DGSN175
200	P5T-C100DGSN200	

Note!

The P5T cylinder with bore 16 mm has only one groove for sensors. When 2 sensors are used for stroke 25 mm or shorter, sensors with 90 degree cable outlet has to be used, see page 23.

Drop-in sensors

The P1D sensors can easily be installed from the side in the sensor groove, at any position along the piston stroke. The sensors are completely recessed and thus mechanically protected. Choose between electronic or reed sensors and several cable lengths and 8 mm and M12 connectors. The same standard sensors are used for all P1D versions.



Electronic sensors

The electronic sensors are "Solid State", i.e. they have no moving parts at all. They are provided with short-circuit protection and transient protection as standard. The built-in electronics make the sensors suitable for applications with high on and off switching frequency, and where very long service life is required.

Technical data

Design	GMR (Giant Magnetic Resistance) magneto-resistive function
Installation	From side, down into the sensor groove, so-called drop-in
Outputs	PNP, normally open (also available in NPN design, normally closed, on request)
Voltage range	10-30 VDC 10-18 V DC, ATEX sensor
Ripple	max 10%
Voltage drop	max 2,5 V
Load current	max 100 mA
Internal consumption	max 10 mA
Actuating distance	min 9 mm
Hysteresis	max 1,5 mm
Repeatability accuracy	max 0,2 mm
On/off switching frequency	max 5 kHz
On switching time	max 2 ms
Off switching time	max 2 ms
Encapsulation	IP 67 (EN 60529)
Temperature range	-25 °C to +75 °C -20 °C to +45 °C, ATEX sensor
Indication	LED, yellow
Material housing	PA 12
Material screw	Stainless steel
Cable	PVC or PUR 3x0.25 mm ² see order code respectively

Reed sensors

The sensors are based on proven reed switches, which offer reliable function in many applications. Simple installation, a protected position on the cylinder and clear LED indication are important advantages of this range of sensors.

Technical data

Design	Reed element
Mounting	From side, down into the sensor groove, so-called drop-in
Output	Normally open, or normally closed
Voltage range	10-30 V AC/DC or 10-120 V AC/DC 24-230 V AC/DC
Load current	max 500 mA for 10-30 V or max 100 mA for 10-120 V max 30 mA for 24-230 V
Breaking power (resistive)	max 6 W/VA
Actuating distance	min 9 mm
Hysteresis	max 1,5 mm
Repeatability accuracy	0,2 mm
On/off switching frequency	max 400 Hz
On switching time	max 1,5 ms
Off switching time	max 0,5 ms
Encapsulation	IP 67 (EN 60529)
Temperature range	-25 °C to +75 °C
Indication	LED, yellow
Material housing	PA12
Material screw	Stainless steel
Cable	PVC or PUR 3x0.14 mm ² see order code respectively

Electronic sensors

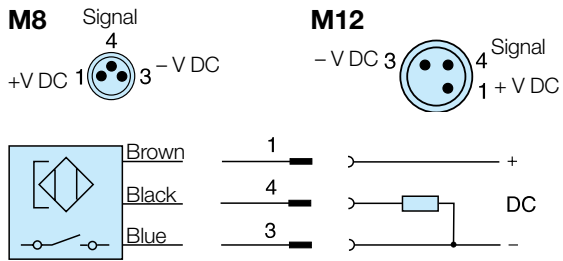

Reed sensors

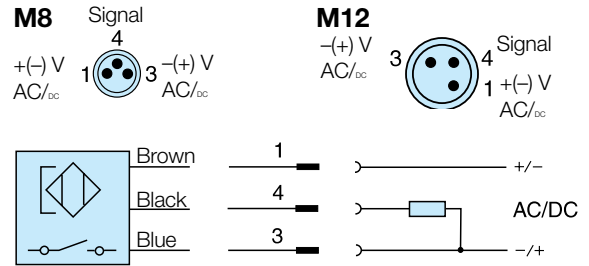

P8S-GCFPX

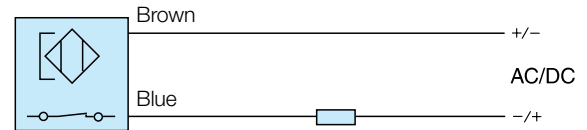

P8S-GRFLX / P8S-GRFLX2

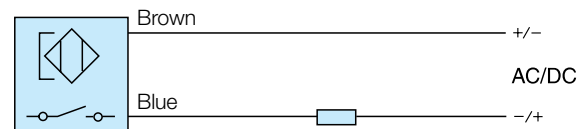

Dimensions (mm)

Sensors

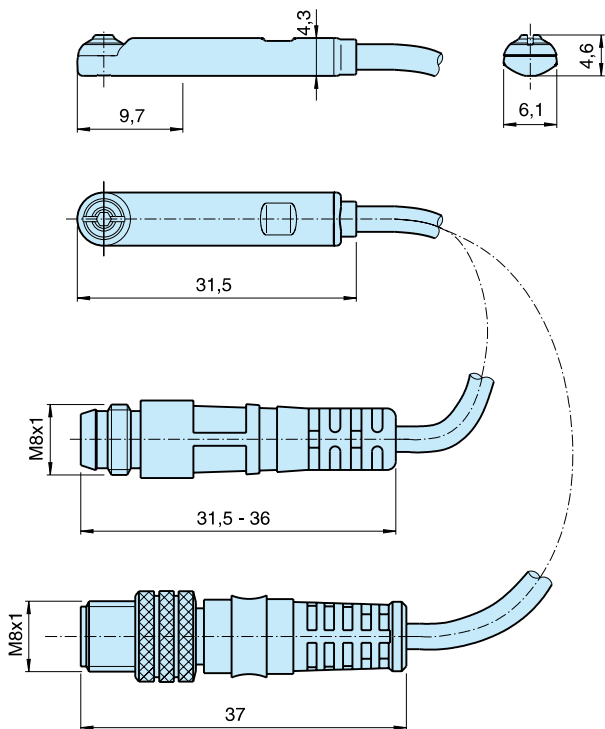

Sensor Installation

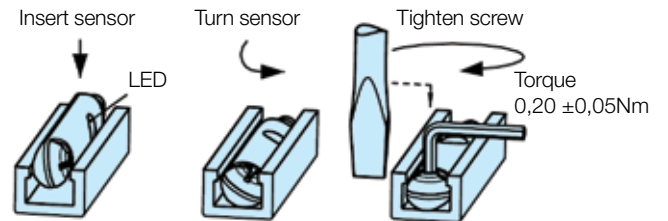

Ordering data

Output/function	Cable/connector	Weight kg	Order code
Electronic sensors , 10-30 V DC			
PNP type, normally open	0,27 m PUR-cable and 8 mm snap-in male connector	0,007	P8S-GPSHX
PNP type, normally open	0,27 m PUR-cable and M12 screw male connector	0,015	P8S-GPMHX
PNP type, normally open	3 m PVC-cable without connector	0,030	P8S-GPFLX
PNP type, normally open	10 m PVC-cable without connector	0,110	P8S-GPFTX
Reed sensors , 10-30 V AC/DC			
Normally open	0,27 m PUR-cable and 8 mm snap-in male connector	0,007	P8S-GSSHX
Normally open	0,27 m PUR-cable and M12 screw male connector	0,015	P8S-GSMHX
Normally open	3 m PVC-cable without connector	0,030	P8S-GSFLX
Normally open	10 m PVC-cable without connector	0,110	P8S-GSFTX
Normally closed	5m PVC-cable without connector ²⁾	0,050	P8S-GCFPX
Reed sensors, 10-120 V AC/DC			
Normally open	3 m PVC-cable without connector	0,030	P8S-GRFLX
Reed sensorer, 24-230 V AC/DC			
Normally open	3 m PVC-cable without connector	0,030	P8S-GRFLX2

2) Without LED

Connecting cables with one connector

The cables have an integral snap-in female connector.



Type of cable	Cable/connector	Weight kg	Order code
Cables for sensors, complete with one female connector			
Cable, Flex PVC	3 m, 8 mm Snap-in connector	0,07	9126344341
Cable, Flex PVC	10 m, 8 mm Snap-in connector	0,21	9126344342
Cable, Polyurethane	3 m, 8 mm Snap-in connector	0,01	9126344345
Cable, Polyurethane	10 m, 8 mm Snap-in connector	0,20	9126344346
Cable, Polyurethane	5 m, M12 screw connector	0,07	9126344348
Cable, Polyurethane	10 m, M12 screw connector	0,20	9126344349

Male connectors for connecting cables

Cable connectors for producing your own connecting cables. The connectors can be quickly attached to the cable without special tools. Only the outer sheath of the cable is removed. The connectors are available for M8 and M12 screw connectors and meet protection class IP 65.



Connector	Weight kg	Order code
M8 screw connector	0,017	P8CS0803J
M12 screw connector	0,022	P8CS1204J

Sensors for special applications

Sensors for applications where the short installation length and the 90 degree cable outlet are important factors. This type of sensor is an good alternative if a cylinder has a short stroke or tight installation.

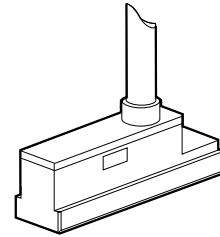

Reed switch sensors

The reed switch sensors incorporate a well-proven, universal-voltage, compact reed switch element, making them suitable for a wide range of applications. They can work with electronic control systems or conventional relay systems. No environment is too severe.

Technical data

Design	Reed
Output	Making
Voltage range	10 to 120 VAC/VDC
Max permissible ripple	10%
Max voltage drop	3 V
Max load current	100 mA
Max breaking power (resistive)	10 W
Min actuating distance	5 mm
Hysteresis	≤1,0 mm
Repeatability accuracy	≤0,2 mm
Max on/off switching frequency	400 Hz
Max on/off switching time	1 ms
Encapsulation	IP 67
Temperature range	-25 °C to +75 °C
Indication	LED, yellow
Shock resistance	30 g
Material, housing	PA 12
Material, mould	Epoxy
Cable	PVC 3x0,14 mm ²
Cable incl. female part connector	PVC 3x0,14 mm ²
Mounting	T slot

Electronic sensors

These sensors are of solid-state type, with no moving parts. Short-circuit and transient protection is incorporated as standard. The integral electronics make these sensors suitable for applications with very high switching frequencies.

Technical data

Design	Hall element
Output	PNP resp. NPN, N.O.
Voltage range	10-30 VDC
Max permissible ripple	10%
Max voltage drop	≤2 V
Max load current	150 mA
Max breaking power (resistive)	6 W
Internal consumption	15 mA
Min actuating distance	5 mm
Hysteresis	≤1,5 mm
Repeatability accuracy	≤0,2 mm
Max on/off switching frequency	50 Hz
Others	5 kHz
Max on/off switching time	0,8/3,0 ms
Encapsulation	IP 67
Temperature range	-25 °C to +75 °C
Indication	LED, yellow
Shock resistance	30 g
Material, housing	PA 12
Material, mould	Epoxy
Cable	PVC 3x0,14 mm ²
Cable incl. female part connector	PVC 3x0,14 mm ²
Connector	Diam. 8 mm snap on
Mounting	T slot

Ordering data

Output	Cable connection	Cable length	Weight kg	Order code
Reed sensors				
making	90°	3,0 m	0,030	P8S-SRELX
making	90°	10,0 m	0,110	P8S-SRETX
making	90°	0,3 m*	0,005	P8S-SRTHX

*) Cable shall be ordered separately.

Ordering data

Output	Cable connection	Cable length	Weight kg	Order code
Electronic sensors				
PNP, N.O.	90°	3,0 m	0,030	P8S-SPELXD
PNP, N.O.	90°	10,0 m	0,110	P8S-SPETXD
PNP, N.O.	90°	0,3 m*	0,005	P8S-SPTHXD

Dimensions (mm)

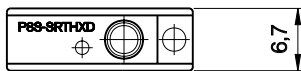
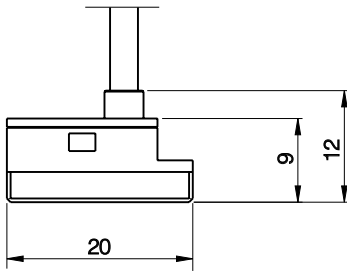
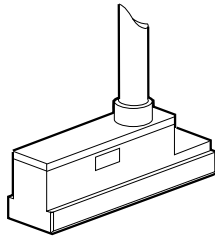

Reed sensor symbol

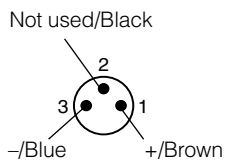
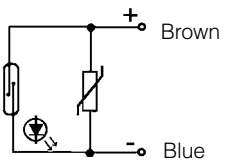

Electronic sensor symbol

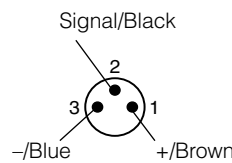
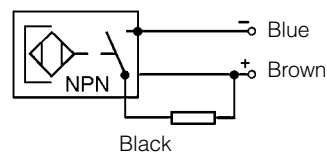
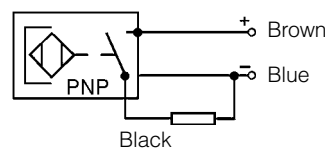



Symbol which indicates sub-components in seal kit (for replacement during maintenance)

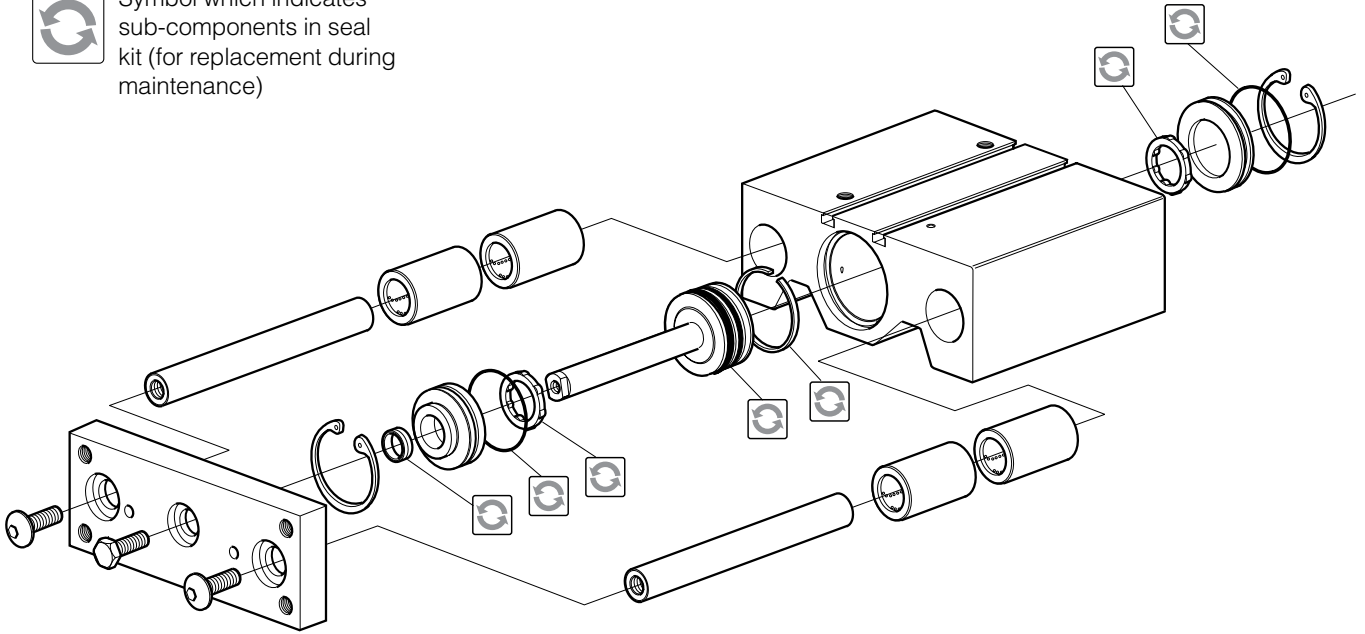

Seal kits

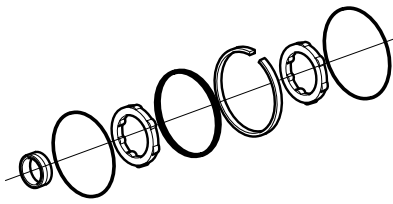

Cylinder diam. mm	Standard temperature Nitrile rubber	High temperature Fluorocarbon rubber
16	PSK-P5T16	PSK-P5T16F
20	PSK-P5T20	PSK-P5T20F
25	PSK-P5T25	PSK-P5T25F
32	PSK-P5T32	PSK-P5T32F
40	PSK-P5T40	PSK-P5T40F
50	PSK-P5T50	PSK-P5T50F
63	PSK-P5T63	PSK-P5T63F
80	PSK-P5T80	PSK-P5T80F
100	PSK-P5T100	PSK-P5T100F

Grease



Weight	Standard temperature	High temperature
30 g	9127394541	9127394521

Parker Worldwide

Europe, Middle East, Africa

AE – United Arab Emirates,
Dubai

Tel: +971 4 8127100
parker.me@parker.com

AT – Austria, Wiener Neustadt

Tel: +43 (0)2622 23501-0
parker.austria@parker.com

AT – Eastern Europe, Wiener
Neustadt

Tel: +43 (0)2622 23501 900
parker.easteurope@parker.com

AZ – Azerbaijan, Baku

Tel: +994 50 2233 458
parker.azerbaijan@parker.com

BE/LU – Belgium, Nivelles

Tel: +32 (0)67 280 900
parker.belgium@parker.com

BY – Belarus, Minsk

Tel: +375 17 209 9399
parker.belarus@parker.com

CH – Switzerland, Etoy

Tel: +41 (0)21 821 87 00
parker.switzerland@parker.com

CZ – Czech Republic, Klecany

Tel: +420 284 083 111
parker.czechrepublic@parker.com

DE – Germany, Kaarst

Tel: +49 (0)2131 4016 0
parker.germany@parker.com

DK – Denmark, Ballerup

Tel: +45 43 56 04 00
parker.denmark@parker.com

ES – Spain, Madrid

Tel: +34 902 330 001
parker.spain@parker.com

FI – Finland, Vantaa

Tel: +358 (0)20 753 2500
parker.finland@parker.com

FR – France, Contamine s/Arve

Tel: +33 (0)4 50 25 80 25
parker.france@parker.com

GR – Greece, Athens

Tel: +30 210 933 6450
parker.greece@parker.com

HU – Hungary, Budapest

Tel: +36 23 885 475
parker.hungary@parker.com

IE – Ireland, Dublin

Tel: +353 (0)1 466 6370
parker.ireland@parker.com

IT – Italy, Corsico (MI)

Tel: +39 02 45 19 21
parker.italy@parker.com

KZ – Kazakhstan, Almaty

Tel: +7 7272 505 800
parker.easteurope@parker.com

NL – The Netherlands, Oldenzaal

Tel: +31 (0)541 585 000
parker.nl@parker.com

NO – Norway, Asker

Tel: +47 66 75 34 00
parker.norway@parker.com

PL – Poland, Warsaw

Tel: +48 (0)22 573 24 00
parker.poland@parker.com

PT – Portugal, Leca da Palmeira

Tel: +351 22 999 7360
parker.portugal@parker.com

RO – Romania, Bucharest

Tel: +40 21 252 1382
parker.romania@parker.com

RU – Russia, Moscow

Tel: +7 495 645-2156
parker.russia@parker.com

SE – Sweden, Spånga

Tel: +46 (0)8 59 79 50 00
parker.sweden@parker.com

SK – Slovakia, Banská Bystrica

Tel: +421 484 162 252
parker.slovakia@parker.com

SL – Slovenia, Novo Mesto

Tel: +386 7 337 6650
parker.slovenia@parker.com

TR – Turkey, Istanbul

Tel: +90 216 4997081
parker.turkey@parker.com

UA – Ukraine, Kiev

Tel +380 44 494 2731
parker.ukraine@parker.com

UK – United Kingdom, Warwick

Tel: +44 (0)1926 317 878
parker.uk@parker.com

ZA – South Africa, Kempton Park

Tel: +27 (0)11 961 0700
parker.southafrica@parker.com

North America

CA – Canada, Milton, Ontario

Tel: +1 905 693 3000

US – USA, Cleveland

Tel: +1 216 896 3000

Asia Pacific

AU – Australia, Castle Hill

Tel: +61 (0)2-9634 7777

CN – China, Shanghai

Tel: +86 21 2899 5000

HK – Hong Kong

Tel: +852 2428 8008

IN – India, Mumbai

Tel: +91 22 6513 7081-85

JP – Japan, Tokyo

Tel: +81 (0)3 6408 3901

KR – South Korea, Seoul

Tel: +82 2 559 0400

MY – Malaysia, Shah Alam

Tel: +60 3 7849 0800

NZ – New Zealand, Mt Wellington

Tel: +64 9 574 1744

SG – Singapore

Tel: +65 6887 6300

TH – Thailand, Bangkok

Tel: +662 186 7000-99

TW – Taiwan, Taipei

Tel: +886 2 2298 8987

South America

AR – Argentina, Buenos Aires

Tel: +54 3327 44 4129

BR – Brazil, Sao Jose dos Campos

Tel: +55 800 727 5374

CL – Chile, Santiago

Tel: +56 2 623 1216

MX – Mexico, Apodaca

Tel: +52 81 8156 6000

European Product Information Centre

Free phone: 00 800 27 27 5374

(from AT, BE, CH, CZ, DE, DK, EE, ES, FI,
FR, IE, IL, IS, IT, LU, MT, NL, NO, PL, PT, RU,
SE, SK, UK, ZA)

Parker Hannifin Ltd.

Tachbrook Park Drive
Tachbrook Park,
Warwick, CV34 6TU
United Kingdom
Tel.: +44 (0) 1926 317 878
Fax: +44 (0) 1926 317 855
parker.uk@parker.com
www.parker.com

