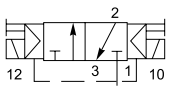
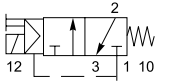

Solenoid operated directional control valves

Internal supply to solenoid valve(s) via port 1.

Max operating pressure 10 bar, temperature range -10°C to +50°C

3/2 valves, internal air, standard temperature

Symbol	Size	Actuation	Return	Min Operating Pressure (bar)	Changeover time (ms) at 6 bar @20°C actua./return	Weight Kg	Order code Without coil	Order code With 24V DC (22mm coil)
	G1/8	Electric signal	Electric signal	1.5	10/10	0.18	P2LAZ311EENDCN	P2LAZ311EENDCB49
	G1/4			1.5	12/12	0.18	P2LBZ312EENDCN	P2LBZ312EENDCB49
	G3/8			1.5	17/17	0.36	P2LCZ313EENDCN	P2LCZ313EENDCB49
	G1/8	Electric signal	Spring	3.0	15/35	0.16	P2LAZ311ESNDCN	P2LAZ311ESNDCB49
	G1/4			3.0	18/45	0.16	P2LBZ312ESNDCN	P2LBZ312ESNDCB49
	G3/8			3.0	27/75	0.35	P2LCZ313ESNDCN	P2LCZ313ESNDCB49

5/2 valves, internal air, standard temperature

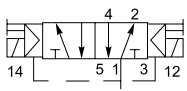
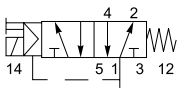
Symbol	Size	Actuation	Return	Min Operating Pressure (bar)	Changeover time (ms) at 6 bar @20°C actua./return	Weight Kg	Order code Without coil	Order code With 24V DC (22mm coil)
	G1/8	Electric signal	Electric signal	1.5	10/10	0.19	P2LAZ511EENDCN	P2LAZ511EENDCB49
	G1/4			1.5	12/12	0.21	P2LBZ512EENDCN	P2LBZ512EENDCB49
	G3/8			1.5	17/17	0.44	P2LCZ513EENDCN	P2LCZ513EENDCB49
	G1/8	Electric signal	Spring	3.0	15/35	0.17	P2LAZ511ESNDCN	P2LAZ511ESNDCB49
	G1/4			3.0	18/45	0.20	P2LBZ512ESNDCN	P2LBZ512ESNDCB49
	G3/8			3.0	27/75	0.43	P2LCZ513ESNDCN	P2LCZ513ESNDCB49

5/3 valves, internal air, standard temperature

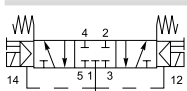
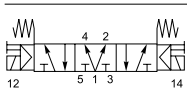
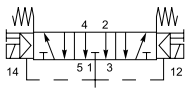
Symbol	Size	Actuation	Return	Min Operating Pressure (bar)	Changeover time (ms) at 6 bar @20°C actua./return	Weight Kg	Order code Without coil	Order code With 24V DC (22mm coil)
	G1/8	Electric/Electric	Self centring	3.0	18/40	0.26	P2LAZ611EENDCN	P2LAZ611EENDCB49
	G1/4		Closed	3.0	22/55	0.28	P2LBZ612EENDCN	P2LBZ612EENDCB49
	G3/8		Centre	3.0	30/90	0.60	P2LCZ613EENDCN	P2LCZ613EENDCB49
	G1/8	Electric/Electric	Self centring	3.0	18/40	0.26	P2LAZ711EENDCN	P2LAZ711EENDCB49
	G1/4		Presurised	3.0	22/45	0.28	P2LBZ712EENDCN	P2LBZ712EENDCB49
	G3/8		Centre	3.0	30/90	0.60	P2LCZ713EENDCN	P2LCZ713EENDCB49
	G1/8	Electric/Electric	Self centring	3.0	18/40	0.26	P2LAZ811EENDCN	P2LAZ811EENDCB49
	G1/4		Vented	3.0	22/45	0.28	P2LBZ812EENDCN	P2LBZ812EENDCB49
	G3/8		Centre	3.0	30/90	0.60	P2LCZ813EENDCN	P2LCZ813EENDCB49

Dimensions

P2LAZ 3/2
Solenoid / Solenoid

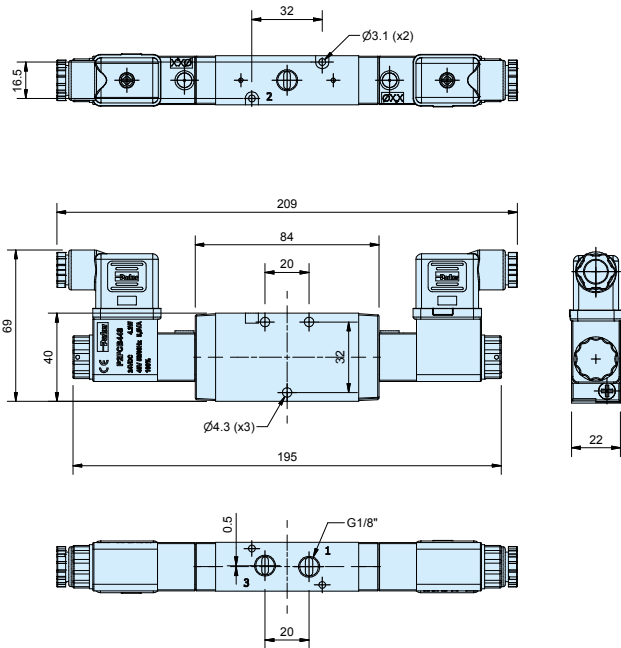

P2LAZ 3/2
Solenoid / Spring

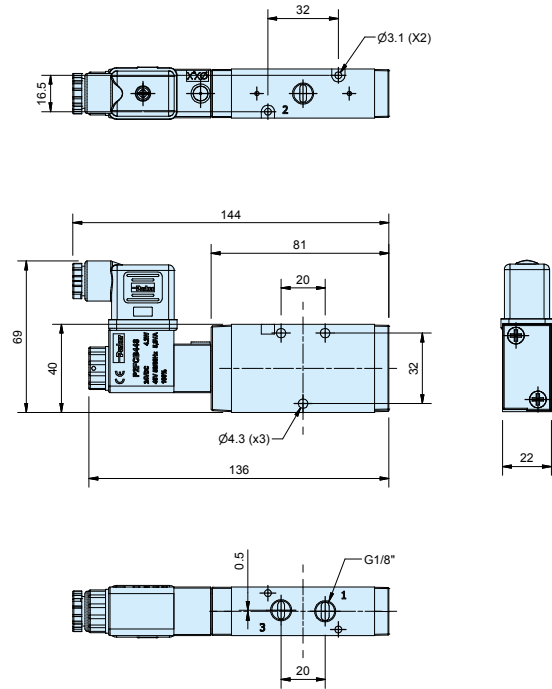

P2LAZ 5/2
Solenoid / Solenoid

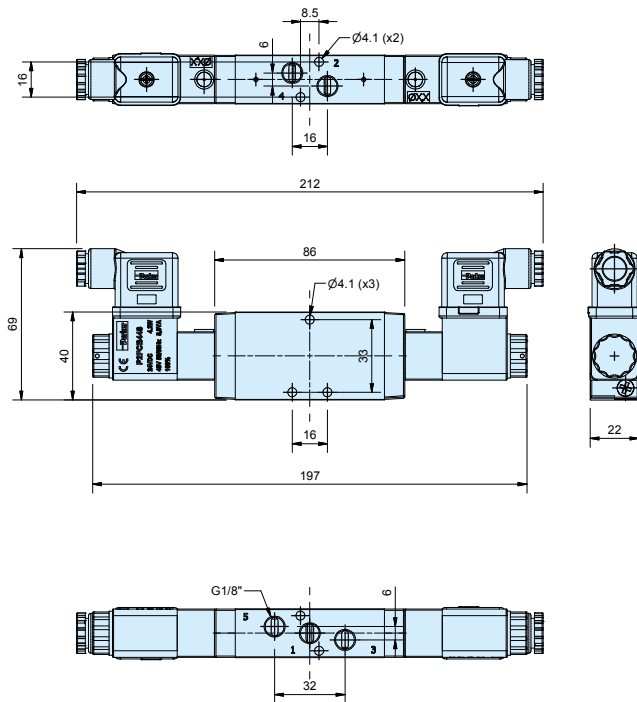

P2LAZ 5/2
Solenoid / Spring

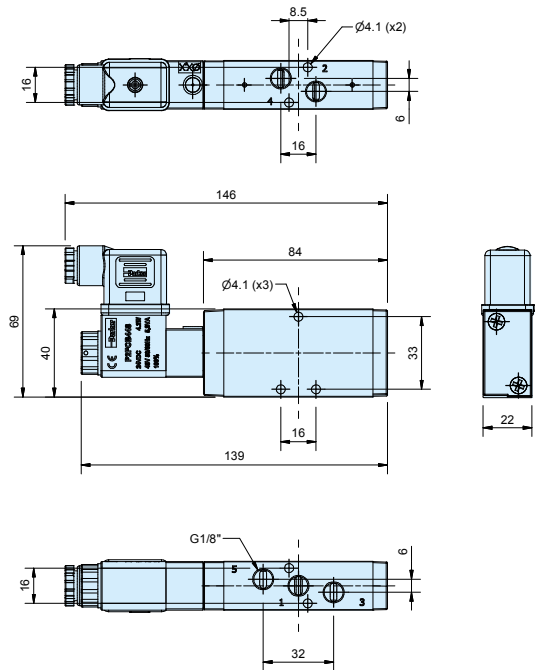

Solenoid valves

Solenoid valves and cable plugs must be ordered separately. One pilot valve is required for each E (NDCN only) in the valve order code.

Dimensions

P2LAZ 5/3

Solenoid / Solenoid

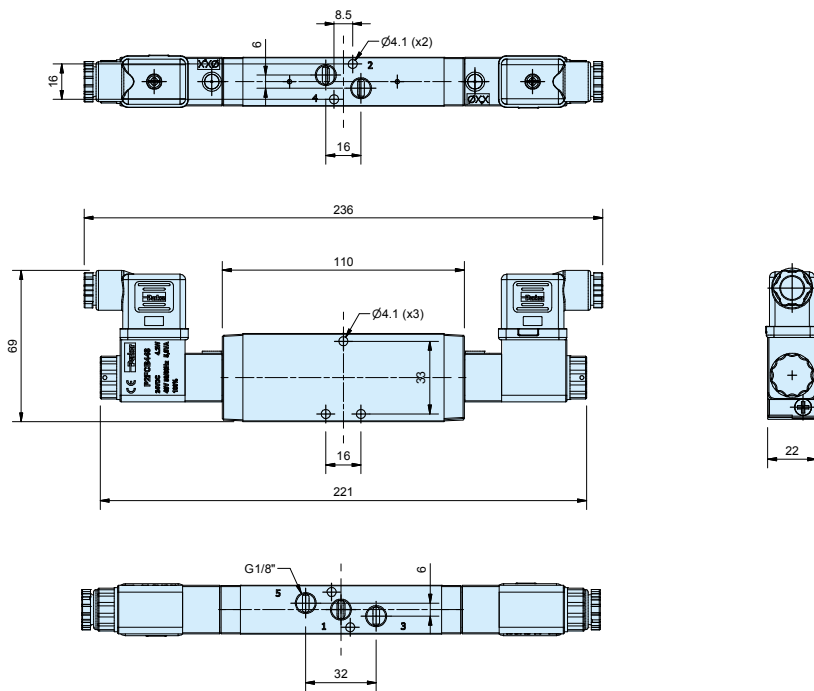

P2LBZ 3/2

Solenoid / Solenoid

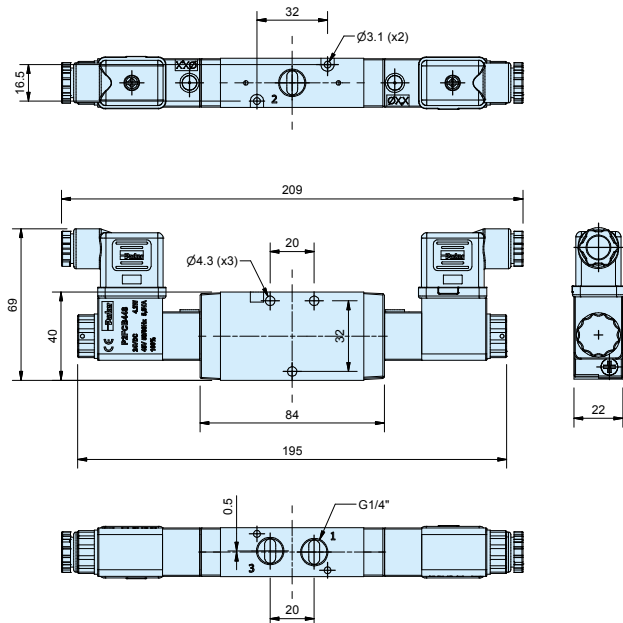

P2LBZ 3/2

Solenoid / Spring

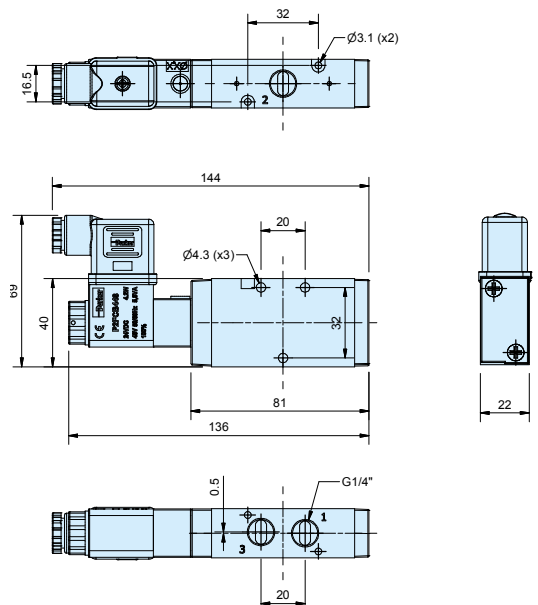

Solenoid valves

Solenoid valves and cable plugs must be ordered separately. One pilot valve is required for each E (NDCN only) in the valve order code.

Dimensions

P2LBZ 5/2
Solenoid / Solenoid

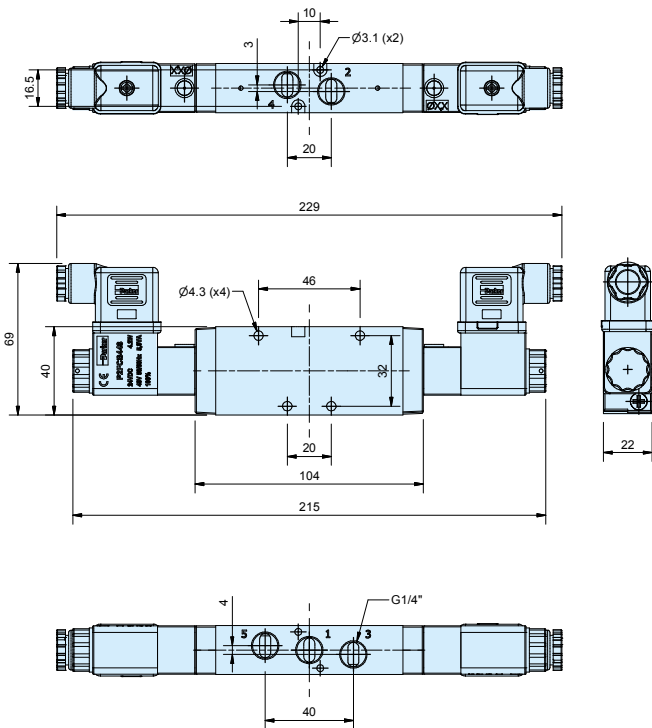

P2LBZ 5/2
Solenoid / Spring

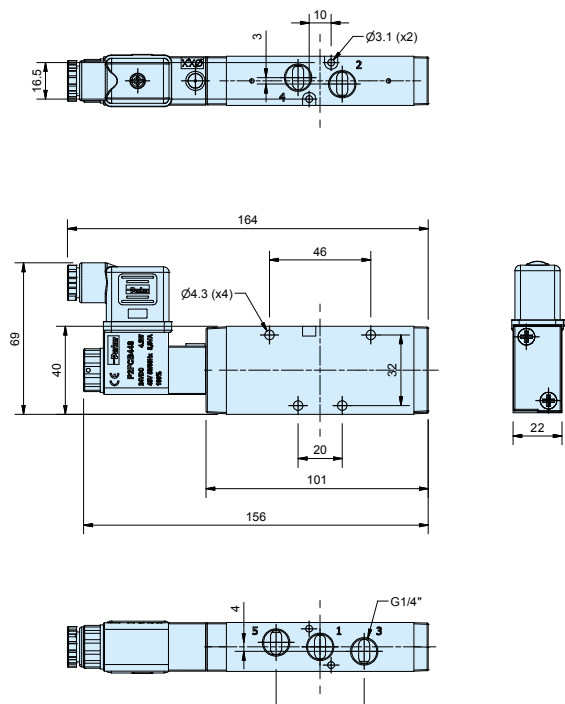

P2LBZ 5/3
Solenoid / Solenoid

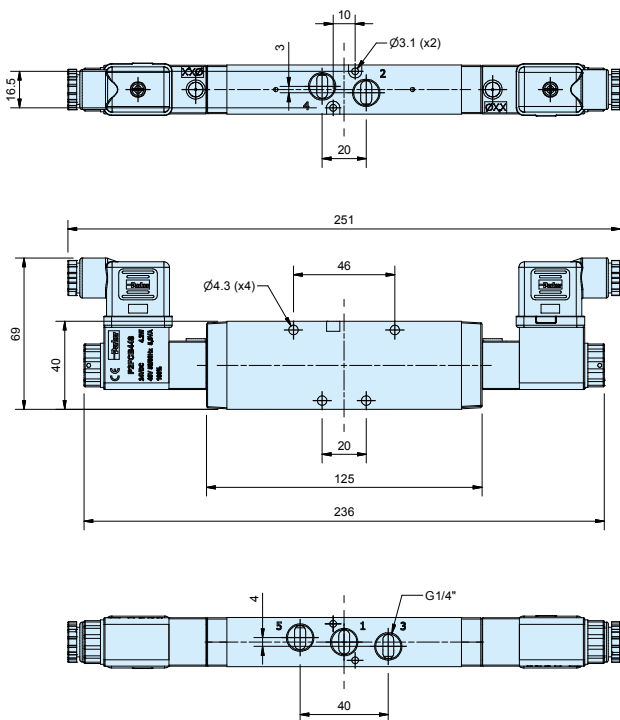

Solenoid valves

Solenoid valves and cable plugs must be ordered separately. One pilot valve is required for each E (NDCN only) in the valve order code.

Dimensions

P2LCZ 3/2
Solenoid / Solenoid

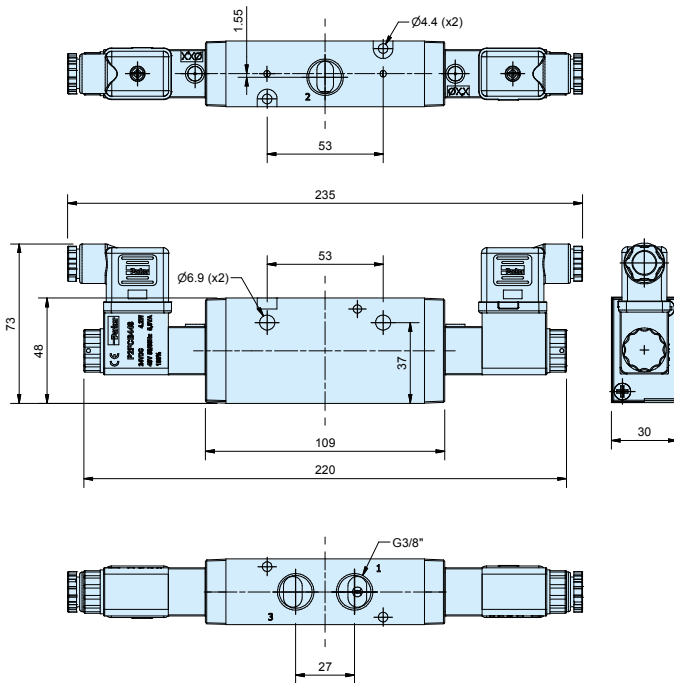

P2LCZ 3/2
Solenoid / Spring

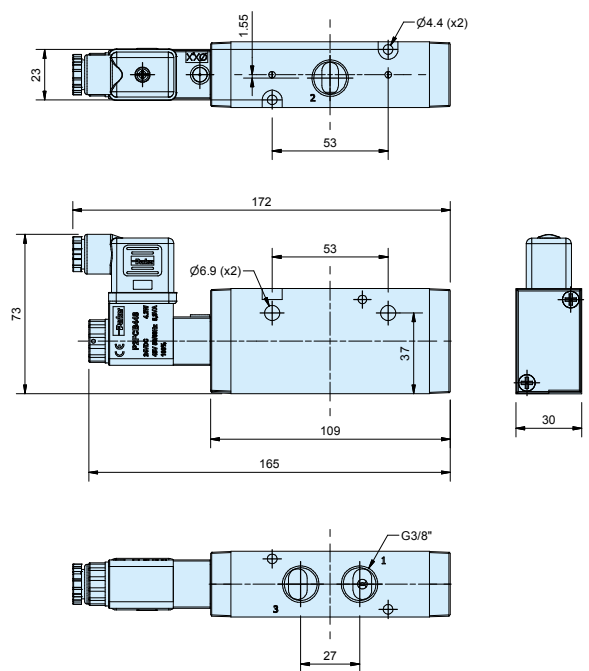

P2LCZ 5/2
Solenoid / Solenoid

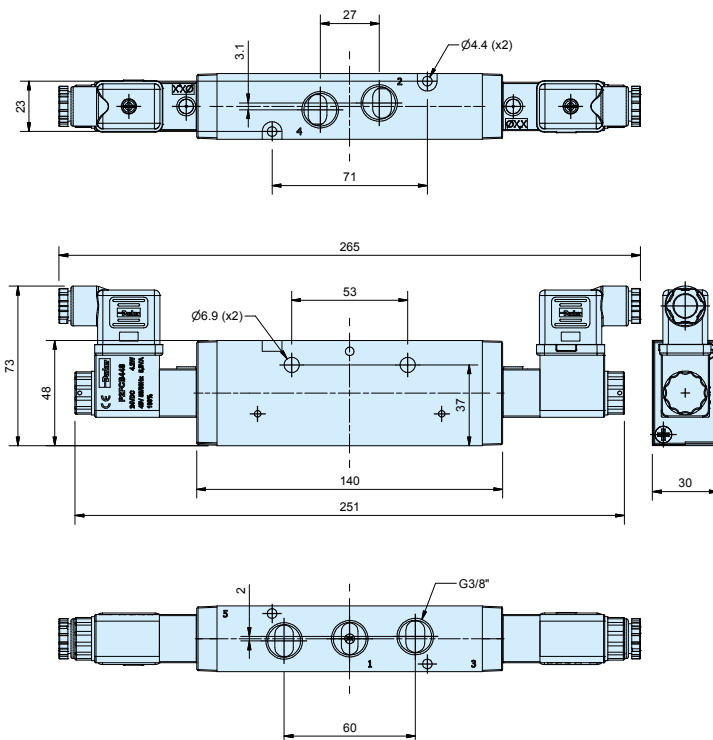

P2LCZ 5/2
Solenoid / Spring

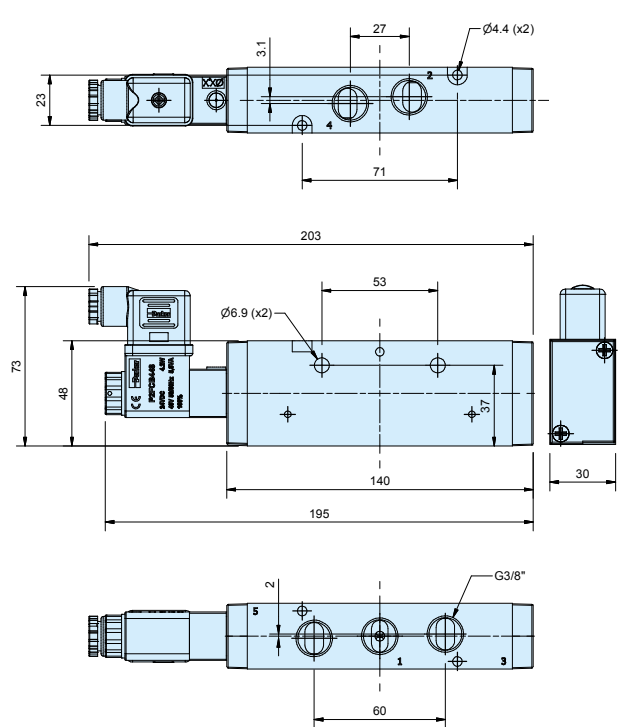

Dimensions

P2LCZ 5/3 Solenoid / Solenoid

