

Tamper Proof Speed Controller with One-touch Fitting Elbow Type/Universal Type

AS□□□1F-T Series

RoHS

Able to adjust flow by a special tool
Prevention of an unnecessary manual operation

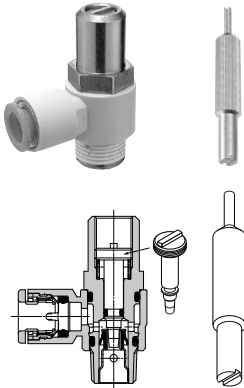

Special tool
Part number: AS-T-1

Elbow type



Universal type



Model

Elbow type	Universal type	Port size	Applicable tubing O.D.														
			Metric size						Inch size								
			3.2	4	6	8	10	12	1/8"	5/32"	3/16"	1/4"	5/16"	3/8"	1/2"		
AS12□1F-M5	AS13□1F-M5	M5 x 0.8	●	●	●	●	●	●									
AS22□1F-01	AS23□1F-01	R 1/8	●	●	●	●	●	●									
AS22□1F-02	AS23□1F-02	R 1/4			●	●	●	●	●								
AS32□1F-02	AS33□1F-02	R 1/4			●	●	●	●	●								
AS32□1F-03	AS33□1F-03	R 3/8			●	●	●	●	●								
AS42□1F-04	AS43□1F-04	R 1/2						●	●								
AS12□1F-U10/32	AS13□1F-U10/32	10-32 UNF								●	●	●	●				
AS22□1F-N01	AS23□1F-N01	NPT 1/8								●	●	●	●	●			
AS22□1F-N02	AS23□1F-N02	NPT 1/4									●	●	●	●	●		
AS32□1F-N02	AS33□1F-N02	NPT 1/4										●	●	●	●	●	
AS32□1F-N03	AS33□1F-N03	NPT 3/8											●	●	●	●	
AS42□1F-N04	AS43□1F-N04	NPT 1/2														●	●

Note 1) □ = Elbow type only

Note 2) Meter-out and meter-in types can be visually differentiated by the flow direction symbol on the resin body.

Specifications

Fluid	Air
Proof pressure	1.5 MPa
Max. operating pressure	1 MPa
Min. operating pressure	0.1 MPa
Ambient and fluid temperature	-5 to 60°C (No freezing)
Applicable tubing material ⁽¹⁾	Nylon, Soft nylon, Polyurethane

Note 1) Use caution regarding the max. operating pressure when soft nylon or polyurethane tubing is used. (Refer to pages 464 and 465 for details.)

Note 2) Brass parts are all electroless nickel plated, provided as standard.

How to Order

AS 2 2 1 1 F - 01 - 06 S T - □

Body size

1	M5 standard
2	1/8, 1/4 standard
3	3/8 standard
4	1/2 standard

Type

2	Elbow
3	Universal

Control

0	Meter-out
1	Meter-in

With One-touch fitting

Port size

M5	M5 x 0.8
01	R 1/8
02	R 1/4
03	R 3/8
04	R 1/2
U10/32	10-32 UNF
N01	NPT 1/8
N02	NPT 1/4
N03	NPT 3/8
N04	NPT 1/2

Tamper proof

Speed Controller requires a special tool for flow adjustment. Order separately with part number, AS-T-1.

With seal

Note) In case that connecting port is either M5 or 10-32 UNF thread, it is not available with seal. With gasket is provided as standard.

Applicable tubing O.D. ^{Note)}

Metric size		Inch size	
23	ø3.2"	01	ø1/8"
04	ø4	03	ø5/32"
06	ø6	05	ø3/16"
08	ø8	07	ø1/4"
10	ø10	09	ø5/16"
12	ø12	11	ø3/8"
		13	ø1/2"

Made to Order

Refer to page 757 for details.

Note) For applicable tubing O.D. selection, refer to the Model.

* Use ø1/8" tube.

Made to Order

Made to Order
(For details, refer to page 757.)

Symbol	Specifications
-X12	Lubricant: Vaseline
-X21	Grease-free (Seal: Fluorine-coated) + Throttle valve (Without check valve)
-X214	Throttle valve (Without check valve)

Needle Valve/Flow Rate Characteristics

Note) The flow rate characteristics are representative values.

AS12□1F
AS13□1F

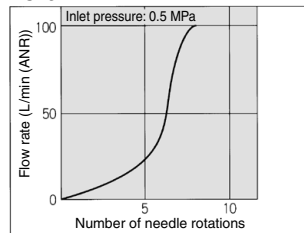

AS22□1F-□01
AS23□1F-□01

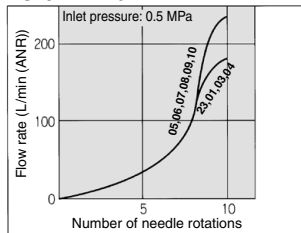

AS22□1F-□02
AS23□1F-□02

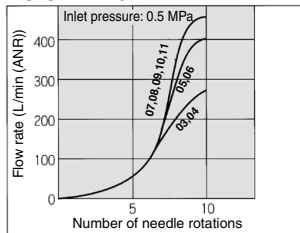

AS32□1F
AS33□1F

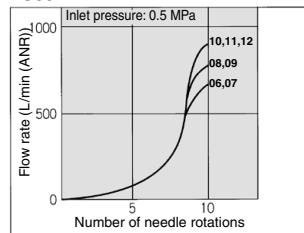

AS42□1F
AS43□1F

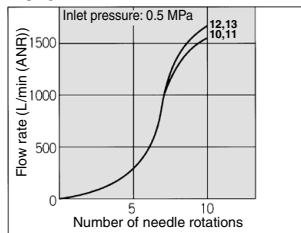

Symbol

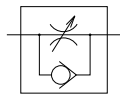

Flow Direction Symbols on Body

	Meter-out type	Meter-in type
Indication symbol		
Symbol		

Caution

Be sure to read this before handling the products. Refer to back page 50 for Safety Instructions and pages 543 to 546 for Flow Control Equipment Precautions.

- AS-F
- TMH
- ASD
- AS
- AS-FE
- KE
- AS-FG
- AS-FP
- AS-FM
- AS-D
- AS-T
- ASP
- ASN
- AQ
- ASV
- AK
- VCHC
- ASR
- ASQ

Flow Rate and Sonic Conductance

Model		AS12□1F AS13□1F	AS22□1F-□01 AS23□1F-□01	AS22□1F-□02 AS23□1F-□02	AS32□1F AS33□1F	AS42□1F AS43□1F
Tubing O.D.	Metric size	ø3.2, ø4, ø6	ø3.2, ø4, ø6, ø8, ø10	ø4, ø6, ø8, ø10	ø6, ø8, ø10, ø12	ø10, ø12
	Inch size	ø1/8", ø5/32", ø3/16", ø1/4"	ø1/8", ø3/16", ø1/4", ø5/32", ø5/16"	ø5/32", ø3/16", ø1/4", ø5/16", ø3/8"	ø1/4", ø5/16", ø3/8"	ø3/8", ø1/2"
Controlled flow	Flow rate (L/min ANRR)	100	180 230	260 390	460 660 790 920	1580 1710
	Sonic conductance (dm ⁷ /s bar)	0.3	0.54 0.7	0.8 1.2	1.4 2 2.4 2.8	4.8 5.2
Critical pressure ratio	Controlled flow	0.2	0.25	0.3	0.25	0.25
	Free flow	0.4	0.2	0.3	0.2	0.3

Note) Flow rate values are at a pressure of 0.5 MPa and a temperature of 20°C.

AS□□□1F-T Series

Construction

Elbow type
Meter-out type

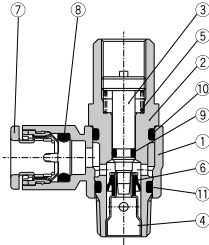

M5 type
U10/32 type

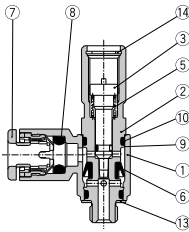

Meter-in type

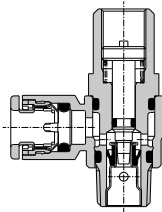

M5 type
U10/32 type

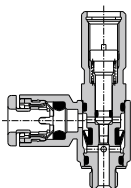

Universal type
Meter-out type

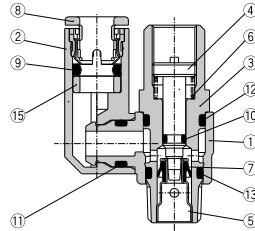

M5 type
U10/32 type

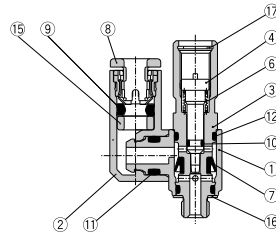

Meter-in type

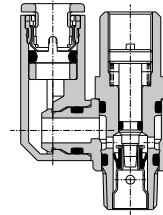

M5 type
U10/32 type

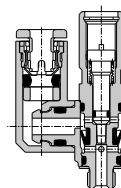

Construction

Elbow type Meter-out type

AS3201F-02

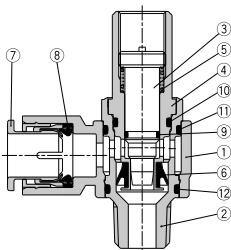

Meter-in type

AS3211F-02

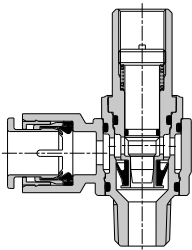

Universal type Meter-out type

AS3301F-02

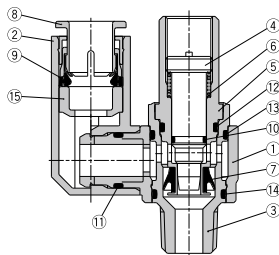

Meter-in type

AS3311F-02

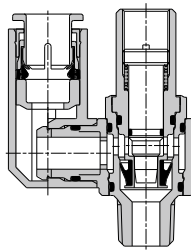

Component Parts

No.	Description	Material	Note
1	Body A	PBT	
2	Body B	Brass	Electroless nickel plated
3	Needle	Brass	Electroless nickel plated
4	Seat ring	Brass	Electroless nickel plated
5	Spring	Steel wire ⁽¹⁾	
6	U seal	HNBR	
7	Cassette	—	
8	Seal	NBR	
9	O-ring	NBR	
10	O-ring	NBR	
11	O-ring	NBR	
12	O-ring	NBR	
13	Gasket	NBR, Stainless steel	
14	Retaining ring for hole type C	Tool steel	

Note 1) M5 and U10/32 type: Stainless steel

Component Parts

No.	Description	Material	Note
1	Body A	PBT	
2	Elbow body	PBT	
3	Body B	Brass	Electroless nickel plated
4	Needle	Brass	Electroless nickel plated
5	Seat ring	Brass	Electroless nickel plated
6	Spring	Steel wire ⁽¹⁾	
7	U seal	HNBR	
8	Cassette	—	
9	Seal	NBR	
10	O-ring	NBR	
11	O-ring	NBR	
12	O-ring	NBR	
13	O-ring	NBR	
14	O-ring	NBR	
15	Spacer	—	
16	Gasket	NBR, Stainless steel	
17	Retaining ring for hole type C	Tool steel	

Note 1) M5 and U10/32 type: Stainless steel

AS-F

TMH

ASD

AS

AS-FE

KE

AS-FG

AS-FP

AS-FM

AS-D

AS-T

ASP

ASN

AQ

ASV

AK

VCHC

ASR
ASQ

AS□□□1F-T Series

Made to Order Specifications

Please contact SMC for detailed dimensions, specifications and lead times.



Lubricant: Vaseline

X12

Ex.) AS1201F-M5-23T-X12

**Grease-free (Seal: Fluorine Coated) +
Throttle Valve (Without Check Valve)**

X21

Ex.) AS1201F-M5-23T-X21

Note 1) Not particle-free

Note 2) Throttle valve is only compatible with the part no. of the meter-out type.

Throttle Valve (Without Check Valve)

X214

Ex.) AS1201F-M5-23T-X214

Note) Throttle valve is only compatible with the product no. of the meter-out type.

AS-F

TMH

ASD

AS

AS-FE

KE

AS-FG

AS-FP

AS-FM

AS-D

AS-T

ASP

ASN

AQ

ASV

AK

VCHC

ASR

ASQ

Tamper Proof Speed Controller with One-touch Fitting In-line Type

AS□□□1F-T Series

Model



Model	Applicable tubing O.D.												
	Metric size						Inch size						
	3.2	4	6	8	10	12	1/8"	5/32"	3/16"	1/4"	5/16"	3/8"	1/2"
AS1001F	●	●	●	●	●	●	●	●	●	●			
AS2001F		●	●				●	●	●				
AS2051F			●	●				●	●	●			
AS3001F			●	●	●	●			●	●	●		
AS4001F					●	●					●	●	

Specifications

Fluid	Air
Proof pressure	1.5 MPa
Max. operating pressure	1 MPa
Min. operating pressure	0.1 MPa
Ambient and fluid temperature	-5 to 60°C (No freezing)
Applicable tubing material ⁽¹⁾	Nylon, Soft nylon, Polyurethane

Note 1) Use caution regarding the max. operating pressure when soft nylon or polyurethane tubing is used. (Refer to pages 464 and 465 for details.)

Note 2) Brass parts are all electroless nickel plated.

Flow Rate and Sonic Conductance

Model		AS1001F	AS2001F	AS2051F	AS3001F	AS4001F					
Tubing O.D.	Metric size	ø3.2, ø4, ø6	ø4	ø6	ø6	ø8	ø10, ø12	ø10	ø12		
	Inch size	ø1/8", ø5/32" ø3/16", ø1/4"	ø5/32"	ø3/16", ø1/4"	ø3/16"	ø1/4", ø5/16"	ø1/4"	ø5/16"	ø3/8"	ø3/8"	ø1/2"
Controlled flow	Flow rate (L/min (ANR))	100	130	230	290	460	420	660	920	1050	1390
Free flow	Sonic conductance dm ² /(s.bar)	0.3	0.4	0.7	0.9	1.4	1.3	2	2.8	3.2	4.2
	Controlled flow	0.2	0.2	0.2	0.2	0.2	0.2	0.2	0.2	0.2	0.2
Critical pressure ratio	Controlled flow	0.25	0.25	0.25	0.25	0.25	0.25	0.25	0.25	0.25	0.25
	Free flow	0.25	0.25	0.25	0.25	0.25	0.25	0.25	0.25	0.25	0.25

Note) Flow rate values are measured at 0.5 MPa and 20°C.

Symbol

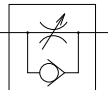

Flow Direction Symbols on Body



Made to Order

Made to Order
(For details, refer to page 760.)

Symbol	Specifications
-X12	Lubricant: Vaseline
-X21	Grease-free (Seal: Fluorine-coated) + Throttle valve (Without check valve)
-X214	Throttle valve (Without check valve)

Caution

Be sure to read this before handling the products. Refer to back page 50 for Safety Instructions and pages 543 to 546 for Flow Control Equipment Precautions.

How to Order

AS 200 1F - 06 T -

Body size ↓

100	M5 standard
200	1/8 standard
205	1/4 standard
300	3/8 standard
400	1/2 standard

With One-touch fittings ↓

Tamper proof

Note) Speed controller requires a special tool for flow adjustment. Order separately with part number, AS-T-1.

Applicable tubing O.D. ^{Note)}

Metric size	Inch size
23	ø3.2 *
04	ø4
06	ø6
08	ø8
10	ø10
12	ø12
01	ø1/8"
03	ø5/32"
05	ø3/16"
07	ø1/4"
09	ø5/16"
11	ø3/8"
13	ø1/2"

Made to Order
Refer to page 760 for details.

Note) For applicable tubing O.D. selection, refer to the Model.
* Use ø1/8" tube.

Needle Valve/Flow Rate Characteristics

Note) The flow rate characteristics are representative values.

AS1001F

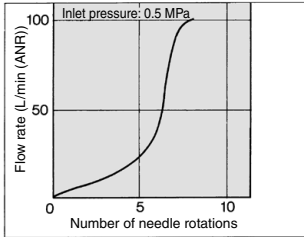

AS2001F

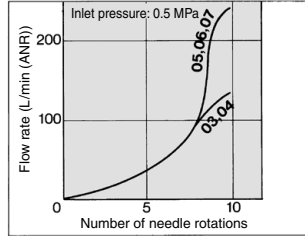

AS2051F

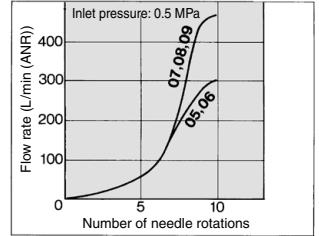

AS3001F

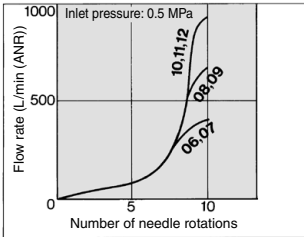

AS4001F

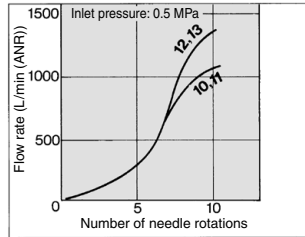

Construction

AS1001F

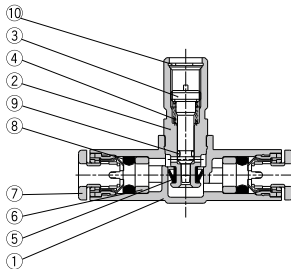

AS2001F to AS4001F

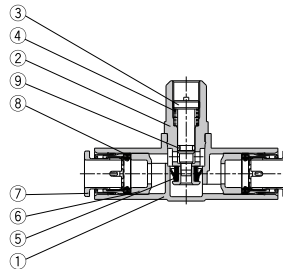

Component Parts

No.	Description	Material	Note
1	Body A	PBT	
2	Body B	Brass	Electroless nickel plated
3	Needle	Brass	Electroless nickel plated
4	Spring	Steel wire ⁽¹⁾	
5	U seal	HNBR	
6	Spacer	—	
7	Cassette	—	
8	Seal	NBR	
9	O-ring	NBR	
10	Retaining ring for hole type C	Tool steel	

Note 1) AS1001F type: Stainless steel

AS-F

TMH

ASD

AS

AS-FE

KE

AS-FG

AS-FP

AS-FM

AS-D

AS-T

ASP

ASN

AQ

ASV

AK

VCHC

ASR

ASQ

AS□□□1F-T Series

Dimensions

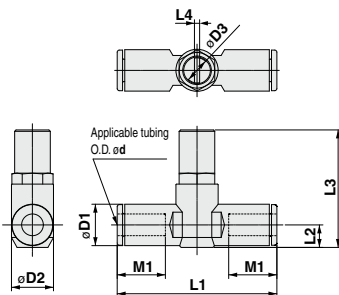

Metric Size

Model	d	D1	D2	D3	L1	L2	L3	L4	M1	Weight(g)
AS1001F-23T	3.2	8.4	10.5	4.5	38	4.5	26	0.7	12.7	8
AS1001F-04T	4	9.3			39.2	5.2	26.6		9	
AS1001F-06T	6	11.6	12.3	7	40.7	6.2	27.7	1.5	13.5	10
AS2001F-04T	4	9.3			40.7	5.2	31.9		12.7	15
AS2001F-06T	6	11.6	15.5	7	44.8	6.3	33	1.5	13.5	16
AS2051F-06T	6	12.8			53.2	6.7	35.2		17	33
AS2051F-08T	8	15.2	20.6	9.5	59.8	8.1	36.5	1.5	18	36
AS3001F-06T	6	12.8			59	7.4	45		17	56
AS3001F-08T	8	15.2	27.6	12	64.4	8.2	45.8	1.5	18	60
AS3001F-10T	10	18.5			71.6	9.8	47.3		21	64
AS3001F-12T	12	20.9	22	68	76	11	48.5	1.5	21	121
AS4001F-10T	10	18.5			77.7	11.3	55.4		21	121
AS4001F-12T	12	20.9	82.1	11.3	56.4	22	125			

Inch Size

Model	d	D1	D2	D3	L1	L2	L3	L4	M1	Weight(g)
AS1001F-01T	1/8"	8.4	10.5	4.5	38	4.5	26	0.7	12.7	8
AS1001F-03T	5/32"	9.3			39.2	5.2	26.6		9	
AS1001F-05T	3/16"	11.4	12.3	7	40.7	6.2	27.7	1.5	13.5	10
AS1001F-07T	1/4"	12			40.7	5.2	31.9		12.7	15
AS2001F-03T	5/32"	9.3	15.5	7	40.7	6.2	32.8	1.5	16.5	21
AS2001F-05T	3/16"	11.4			50	6.2	32.8		17	19
AS2001F-07T	1/4"	13.2	20.6	9.5	52.2	7.1	33.7	1.5	17	33
AS2051F-05T	3/16"	11.4			52.2	6.2	34.9		16.5	35
AS2051F-07T	1/4"	13.2	27.6	12	54.4	7.1	35.7	1.5	17	33
AS2051F-09T	5/16"	15.2			59.8	8.1	36.7		18	36
AS3001F-07T	1/4"	13.2	22	68	59	7.4	45.2	1.5	17	56
AS3001F-09T	5/16"	15.2			64.4	8.2	46		18	60
AS3001F-11T	3/8"	17.9	22	125	70.8	9.5	47.2	1.5	21	72
AS4001F-11T	3/8"	17.9			76.9	10.3	55.5		21	129
AS4001F-13T	1/2"	21.7	83.1	11.6	56.9	22	142			

Made to Order



Lubricant: Vaseline

X12

Ex.) AS1001F-23T-X12

Grease-free (Seal: Fluorine Coated) + Throttle Valve (Without Check Valve)

X21

Ex.) AS1001F-23T-X21

Note 1) Not particle-free

Throttle Valve (Without Check Valve)

X214

Ex.) AS1001F-23T-X214

Tamper Proof Dual Speed Controller with One-touch Fitting

ASD□□□F-T Series



- AS-F
- TMH
- ASD
- AS
- AS-FE
- KE
- AS-FG
- AS-FP
- AS-FM
- AS-D
- AS-T
- ASP
- ASN
- AQ
- ASV
- AK
- VCHC
- ASR
ASQ

Specifications

Fluid	Air
Proof pressure	1.5 MPa
Max. operating pressure	1 MPa
Min. operating pressure	0.1 MPa
Ambient and fluid temperature	-5 to 60°C (No freezing)
Applicable tubing material (1)	Nylon, Soft nylon, Polyurethane

Note 1) Use caution regarding the max. operating pressure when soft nylon or polyurethane tubing is used. (Refer to pages 464 and 465 for details.)

Note 2) Brass parts are all electroless nickel plated, provided as standard.



Model

Model	Port size	Applicable tubing O.D.														
		Metric size					Inch size									
		4	6	8	10	12	1/8"	5/32"	3/16"	1/4"	5/16"	3/8"				
ASD230F-M5	M5 x 0.8	●	●													
ASD330F-01	R 1/8		●													
ASD430F-02	R 1/4		●	●	●											
ASD530F-02	R 1/4		●	●	●	●										
ASD530F-03	R 3/8		●	●	●	●										
ASD630F-04	R 1/2				●	●										
ASD230F-U10/32	10-32 UNF						●	●	●	●						
ASD330F-N01	NPT 1/8								●	●	●	●				
ASD430F-N02	NPT 1/4										●	●	●	●		
ASD530F-N02	NPT 1/4										●	●	●	●		
ASD530F-N03	NPT 3/8										●	●	●	●		
ASD630F-N04	NPT 1/2											●	●	●	●	

Symbol

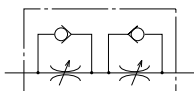

Flow Rate and Sonic Conductance

	Model	ASD230F	ASD330F	ASD430F		ASD530F			ASD630F	
		Metric size	ø4, ø6	ø6, ø8	ø6	ø8, ø10	ø6	ø8	ø10, ø12	ø10
Tubing O.D.	Metric size	ø1/8"	ø3/16"	ø3/16"	ø1/4"	ø1/4"	ø5/16"	ø3/8"	—	ø3/8"
	Inch size	ø1/8"	ø3/16"	—	ø1/4"	ø1/4"	ø5/16"	ø3/8"	—	ø3/8"
Controlled flow	Flow rate (L/min (ANR))	75	175	295	350	500	600	700	1200	1300
Free flow	Sonic conductance (dm ³ /(s.bar))	0.22	0.54	0.9	1.06	1.52	1.82	2.14	3.66	3.96
Critical pressure ratio	Controlled flow	0.25	0.2	0.2		0.2			0.2	
	Free flow	0.3	0.15	0.15		0.15			0.15	

Note) Flow rate values are measured at 0.5 MPa and 20°C.

Flow Direction Symbols on Body

	Meter-out type	Meter-in type
Indication symbol		
Symbol		

Made to Order



Lubricant: Vaseline

X12

How to Order

ASD F - - S T -

Body size

2	M5 standard
3	1/8 standard
4	1/4 standard
5	3/8 standard
6	1/2 standard

Universal

With One-touch fitting

Tamper proof

Note) Speed controller requires a special tool for flow adjustment. Order separately with part number, AS-T-1.

With seal

Note) In case that connecting port is either M5 or 10-32 UNF thread, it is not available with seal. With gasket is provided as standard.

Applicable tubing O.D. (Note)

Metric size		Inch size	
04	ø4	01	ø1/8"
06	ø6	03	ø5/32"
08	ø8	05	ø3/16"
10	ø10	07	ø1/4"
12	ø12	09	ø5/16"
		11	ø3/8"

Note) For applicable tubing O.D. selection, refer to the Model on page 761.

Port size

M5	M5 x 0.8
01	R 1/8
02	R 1/4
03	R 3/8
04	R 1/2
U10/32	10-32 UNF
N01	NPT 1/8
N02	NPT 1/4
N03	NPT 3/8
N04	NPT 1/2

Made to Order

X12 Lubricant: Vaseline
Ex.) ASD230F-M5-04T-X12

Needle Valve/Flow Rate Characteristics

Note) The flow rate characteristics are representative values.

ASD230F

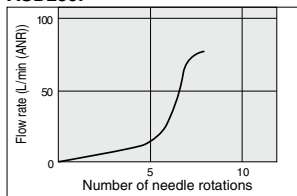

ASD330F

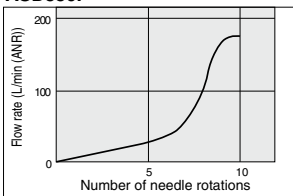

ASD430F

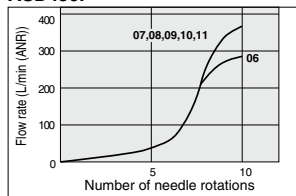

ASD530F

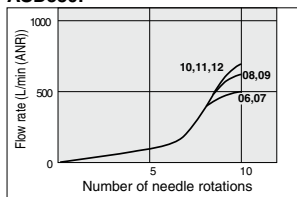

ASD630F

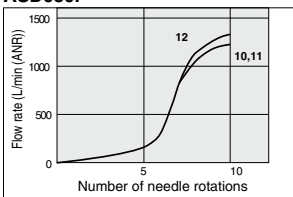

Construction

ASD230F

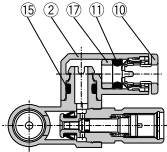

ASD330F/430F
ASD530F/630F

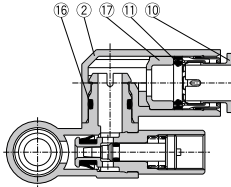

ASD530F-02

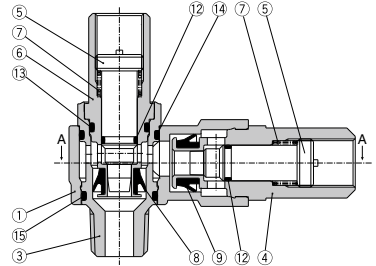
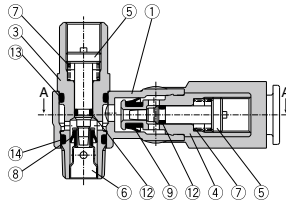
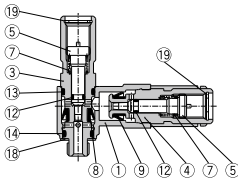
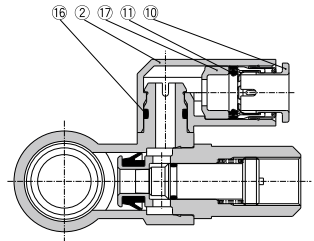

Component Parts

No.	Description	Material	Note
1	Body A	PBT	
2	Elbow body	PBT	
3	Body B	Brass	Electroless nickel plated
4	Body B	Brass	Electroless nickel plated
5	Needle	Brass	Electroless nickel plated
6	Seat ring	Brass	Electroless nickel plated
7	Spring	Steel wire ⁽¹⁾	
8	U seal	HNBR	
9	U seal	HNBR	
10	Cassette	—	
11	Seal	NBR	
12	O-ring	NBR	

Component Parts

No.	Description	Material	Note
13	O-ring	NBR	
14	O-ring	NBR	
15	O-ring	NBR	
16	O-ring	NBR	
17	Spacer	—	
18	Gasket	NBR, Stainless steel	
19	Retaining ring for hole type C	Tool steel	

Note 1) ASD230F: Stainless steel

AS-F
TMH
ASD
AS
AS-FE
KE
AS-FG
AS-FP
AS-FM
AS-D
AS-T
ASP
ASN
AQ
ASV
AK
VCHC
ASR
ASQ

ASD F-T Series

Dimensions

Metric size

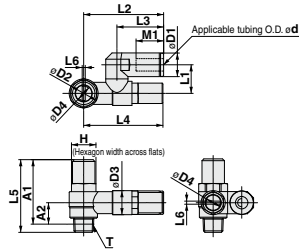

Metric Size

Model	d	T	H	D1	D2	D3	D4	L1	L2	L3	L4	L5	L6	A1*	A2*	M1	Weight(g)
ASD230F-M5-04T	4	M5 x 0.8	8	9.3	9.6	10	4.5	11.7	29.4	17.5	30.7	31	0.7	27.4	7.8	12.9	17
ASD230F-M5-06T	6			11.6					32.5	20.6						13.7	18
ASD330F-01-06ST	6	R 1/8	12	11.6	14.2	11.8	7	14	38.5	22.9	38.9	34.7	1.5	31.6	10.6	13.7	36
ASD330F-01-08ST	8			15.2				44.8	28.2	38.2	18.5					38	
ASD430F-02-06ST	6	R 1/4	17	12.8	18.5	15	7	18	43.5	25.2	41.7	40.2	1.5	34.7	11	17	72
ASD430F-02-08ST	8			15.2				46.5	28.2	40.2						18.5	74
ASD430F-02-10ST	10	R 1/4	19	18.5	23	19.8	9.5	19.7	49.3	31	53.7	54.8	1.5	49.3	15.4	21	77
ASD530F-02-06ST	6			20.3				48.3	25.2	17						107	
ASD530F-02-08ST	8	R 1/4	19	15.2	23	19.8	9.5	20.3	51.3	28.2	53.7	54.8	1.5	49.3	15.4	18.5	109
ASD530F-02-10ST	10			18.5				54.1	32.6	21						113	
ASD530F-02-12ST	12	R 3/8	19	20.9	23	19.8	9.5	23.1	55.9	34.4	53.7	52.6	1.5	47.4	14	22	116
ASD530F-03-06ST	6			12.8				48.3	25.2	17						116	
ASD530F-03-08ST	8	R 3/8	19	15.2	23	19.8	9.5	20.3	51.3	28.2	53.7	52.6	1.5	47.4	14	18.5	135
ASD530F-03-10ST	10			18.5				54.1	32.6	21						140	
ASD530F-03-12ST	12	R 1/2	24	20.9	28.6	26.5	12	23.1	55.9	34.4	69.1	62.9	1.5	55.8	18.6	22	143
ASD630F-04-10ST	10			18.5				64.3	32.6	21						254	
ASD630F-04-12ST	12	R 1/2	24	20.9	28.6	26.5	12	25.9	66.1	34.4	69.1	62.9	1.5	55.8	18.6	22	256

* Reference dimensions of M5 x 0.8, R threads after installation.

Dimensions

Inch size

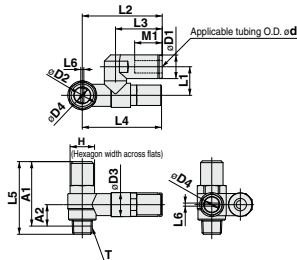

Inch Size

Model	d	T	H	D1	D2	D3	D4	L1	L2	L3	L4	L5	L6	A1*	A2*	M1	Weight(g)
ASD230F-U10/32-01T	1/8"	10-32 UNF	8	8.4	9.6	10	4.5	11.7	29.4	17.5	30.7	31	0.7	27.4	7.8	12.9	17
ASD230F-U10/32-03T	5/32"			11.4					35.2	23.3						16.5	20
ASD230F-U10/32-05T	3/16"	NPT 1/8	12.7	12	14.2	11.8	7	14	38.5	23.9	38.9	34.7	1.5	31.6	10.6	13.5	18
ASD230F-U10/32-07T	1/4"			11.6				44.8	28.2	38.2	18.5					38	
ASD330F-N01-05ST	3/16"	NPT 1/4	17.5	13.2	18.5	15	7	18	43.9	25.6	41.7	40.2	1.5	34.7	11	17	74
ASD330F-N01-07ST	1/4"			15.2				46.5	28.2	40.2						18.5	74
ASD330F-N01-09ST	5/16"	NPT 1/2	19	13.2	23	19.8	9.5	20.3	48.7	25.6	53.7	54.8	1.5	49.3	15.4	17	109
ASD430F-N02-09ST	5/16"			15.2				51.3	28.2	18.5						33	
ASD530F-N02-11ST	3/8"	NPT 3/8	19	18.5	23	19.8	9.5	23.1	54.1	32.6	53.7	52.6	1.5	47.4	14	17	117
ASD530F-N02-11ST	3/8"			13.2				48.7	25.6	17						135	
ASD530F-N03-09ST	5/16"	NPT 1/2	23.8	15.2	28.6	26.5	12	20.3	51.3	28.2	69.1	62.9	1.5	55.8	18.6	21	144
ASD530F-N03-11ST	3/8"			18.5				54.1	32.6	21						144	
ASD630F-N04-11ST	3/8"	NPT 1/2	23.8	18.5	28.6	26.5	12	25.9	64.3	32.6	69.1	62.9	1.5	55.8	18.6	21	256

* Reference dimensions of 10-32 UNF and NPT threads after installation.



ASD□□□F-T Series Specific Product Precautions

Be sure to read this before handling the products. Refer to back page 50 for Safety Instructions and pages 543 to 546 for Flow Control Equipment Precautions.

Design/Selection

⚠ Caution

1. Single acting cylinder

When controlling a single acting cylinder, the cylinder's return speed will differ depending on the operating conditions. Operate after confirming the maximum return speeds shown in the table below.

Speed Controller	Cylinder	Solenoid valve	Tubing	Silencer	Max. return speed (mm/s)		
					10	20	30
ASD230F	CJ2	SYJ500	TU0604 1m	AN110-01			
ASD330F	CM2	SYJ700	TU0604 1m	AN110-01			

* Values are measured at 0.5 MPa and 20°C.

<Operating conditions>

- Cylinder extension speed: 100 mm/s
- Meter-out needle fully open

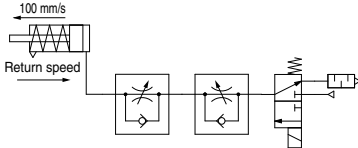

(Reference) Recommended circuit for high return speed

When low extension speed and high return speed are desired, the following circuit using 3-port is recommended.

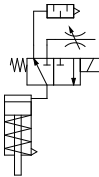

Note) Use AS-F series with -X214 for the throttle valve.

AS-F
TMH
ASD
AS
AS-FE
KE
AS-FG
AS-FP
AS-FM
AS-D
AS-T
ASP
ASN
AQ
ASV
AK
VCHC
ASR
ASQ

Tamper Proof Speed Controller Standard Type Elbow Type (Metal Body)

AS□2□0-T Series

RoHS

Model/ Specifications



Specifications	Model	AS12□0-M5	AS12□0-U10/32	AS22□0-01	AS22□0-02	AS32□0-02	AS32□0-03	AS42□0-04
Port size		M5 x 0.8	10-32 UNF	1/8	1/4	1/4, 3/8 (Note 4)	3/8	1/2
Fluid		Air						
Proof pressure		1.5 MPa						
Max. operating pressure		1 MPa						
Min. operating pressure		0.1 MPa						
Ambient and fluid temperature		-5 to 60°C (No freezing)						
Controlled flow	Flow rate (L/min (ANRI))	105	230	460	920	1700		
Free flow	Sonic conductance (dm ³ /s(bar))	0.32	0.7	1.4	2.8	5.2		
	Controlled flow	0.2	0.25	0.3	0.25	0.25		
Critical pressure ratio	Free flow	0.4	0.2	0.3	0.2	0.3		

Note 1) Flow rate values are measured at 0.5 MPa and 20°C.

Note 2) Meter-out and meter-in types can be visually differentiated by the flow direction symbol on the resin body.

Note 3) Brass parts are all electroless nickel plated, provided as standard.

Note 4) Female thread port size (valve side) is 3/8 for AS32□0-□02.

How to Order

Symbol

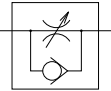

AS **2** **2** **0** **0** - **01** - **S** **T**

Body size

1	M5 standard
2	1/8, 1/4 standard
3	3/8 standard
4	1/2 standard

Elbow

Control

0	Meter-out
1	Meter-in

Tamper proof

Note) Speed controller requires a special tool for flow adjustment. Order separately with part number, AS-T-1.

With seal

Note) When connecting port is either M5 or 10-32 UNF thread, it is not available with seal. With gasket is provided as standard.

Port size

Symbol	Cylinder side	In the side of solenoid valve
M5	M5 x 0.8	M5 x 0.8
01	R 1/8	Rc 1/8
02	R 1/4	Rc 1/4 (Note 1)
		Rc 3/8 (Note 2)
03	R 3/8	Rc 3/8
04	R 1/2	Rc 1/2
F01	R 1/8	G 1/8
F02	R 1/4	G 1/4 (Note 1)
		G 3/8 (Note 2)
F03	R 3/8	G 3/8
F04	R 1/2	G 1/2
U10/32	10-32 UNF	10-32 UNF
N01	NPT 1/8	NPT 1/8
N02	NPT 1/4	NPT 1/4 (Note 1)
		NPT 3/8 (Note 2)
N03	NPT 3/8	NPT 3/8
N04	NPT 1/2	NPT 1/2

Note 1) AS22□0-□02

Note 2) AS32□0-□02

Caution

Be sure to read this before handling the products. Refer to back page 50 for Safety Instructions and pages 543 to 546 for Flow Control Equipment Precautions.

Tamper Proof Speed Controller Standard Type, Elbow Type (Metal Body) **AS□2□0-T Series**

Needle Valve/Flow Rate Characteristics

Note) The flow rate characteristics are representative values.

AS12□0-M5·AS12□0-U10/32

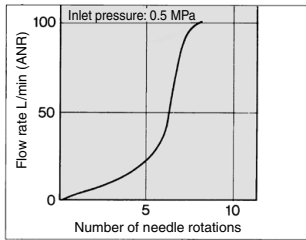

AS22□0-01

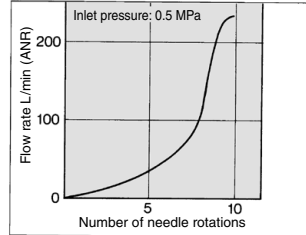

AS22□0-02

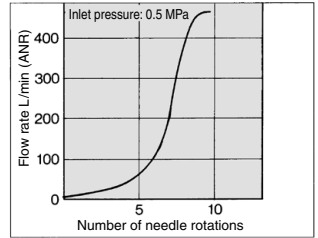

AS32□0

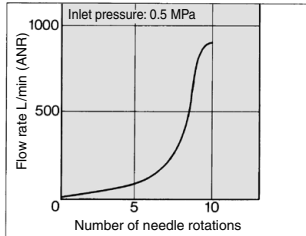

AS42□0

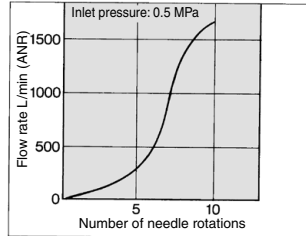

Construction

Meter-out type

M5 type
U10/32 type

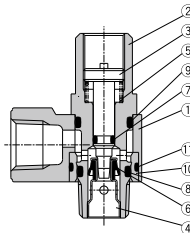
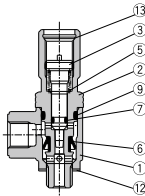

AS3200-02

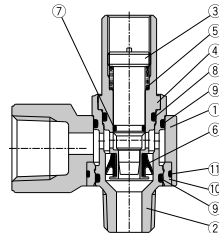

Meter-in type

M5 type
U10/32 type

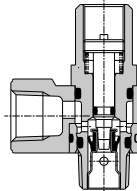
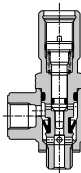

AS3210-02

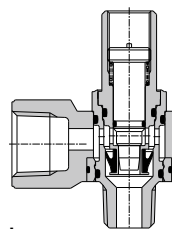

Component Parts

No.	Description	Material	Note
1	Body A	Zinc alloy	Chromate plated
2	Body B	Brass	Electroless nickel plated
3	Needle	Brass	Electroless nickel plated
4	Seat ring	Brass	Electroless nickel plated
5	Spring	Steel wire ⁽¹⁾	
6	U seal	HNBR	
7	O-ring	NBR	

Component Parts

No.	Description	Material	Note
8	O-ring	NBR	
9	O-ring	NBR	
10	Bushing	PBT	
11	O-ring	NBR	
12	Gasket	NBR, Stainless steel	
13	Retaining ring for hole type C	Tool steel	

Note 1) M5 and U10/32 type: Stainless steel

AS-F
TMH
ASD
AS
AS-FE
KE
AS-FG
AS-FP
AS-FM
AS-D
AS-T
ASP
ASN
AQ
ASV
AK
VCHC
ASR
ASQ

AS□2□0-T Series

Dimensions

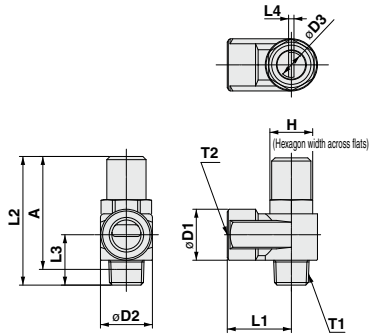

Dimensions

Model	T1	T2	H	D1	D2	D3	L1	L2	L3	L4	A*	Weight (g)
AS12□0-M5-T	M5 x 0.8	M5 x 0.8	8	9	9	4.5	10	31	10.3	0.7	27.4	13
AS12□0-U10/32-T	10-32 UNF	10-32 UNF										
AS22□0-01-ST	R 1/8	Rc 1/8	12	14.3	14.6	7	18	34.7	13.2	1.5	31.6	33
AS22□0-F01-ST		G 1/8										
AS22□0-N01-ST	NPT 1/8	NPT 1/8	12.7									
AS22□0-02-ST	R 1/4	Rc 1/4	17	18	19.5	7	27.2	40.2	17.5	1.5	36.7	72
AS22□0-F02-ST		G 1/4										
AS22□0-N02-ST	NPT 1/4	NPT 1/4	17.5									
AS32□0-02-ST	R 1/4	Rc 3/8	19	22.5	24.3	9.5	30	54.8	21.9	1.5	49.3	123
AS32□0-F02-ST		G 3/8										
AS32□0-N02-ST	NPT 1/4	NPT 3/8										
AS32□0-03-ST	R 3/8	Rc 3/8	19	22.5	24.3	9.5	30	52.6	19.7	1.5	47.4	128
AS32□0-F03-ST		G 3/8										
AS32□0-N03-ST	NPT 3/8	NPT 3/8										
AS42□0-04-ST	R 1/2	Rc 1/2	24	27.5	28.5	12	38.5	62.9	25.8	1.5	55.8	222
AS42□0-F04-ST		G 1/2										
AS42□0-N04-ST	NPT 1/2	NPT 1/2	23.8									

* Reference thread dimensions after installation.