

Blow Nozzles

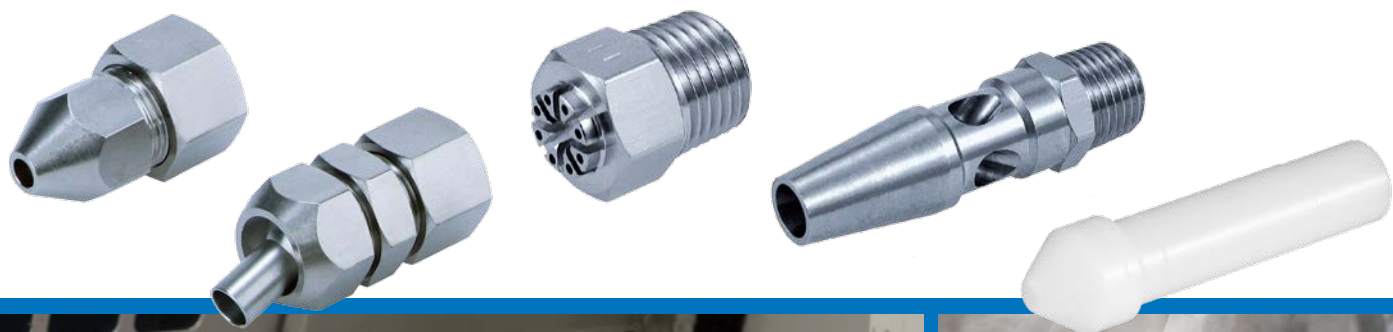

CONTENTS

| | |
|--|-------|
| Nozzle Selection Chart | p. 1 |
| Nozzle Variations | p. 3 |
| Applications | p. 6 |
| Jet Shape and Impact Pressure Distribution Diagram | p. 7 |
| Nozzles for Blowing KN Series | p. 9 |
| Made to Order | p. 13 |
| Related Products Vacuum Flow ZH-X226/X338/X249 | p. 16 |

| | |
|---|------------|
| Equipment for Blowing | p. 20 |
| Technical Data: Comparison Table (Thrust, Noise, Flow consumption, Air flow) | p. 22 |
| Energy Saving Program | p. 23 |
| Model Selection: Recommended Circuit Configuration for Blowing ... | p. 24 |
| Glossary of Terms | p. 26 |
| Safety Instructions | Back cover |

What is the purpose of blowing?

Removal of foreign matter

Yes

Foreign matter type

1 Small foreign matter
(Dust, Cutting chips, etc.)

Removal of foreign matter across a wide area

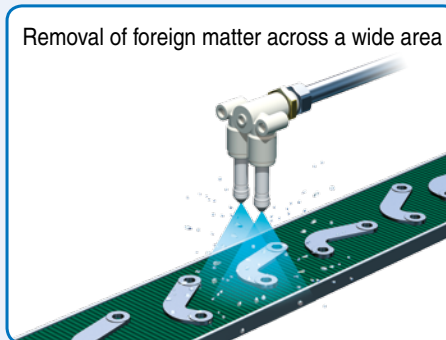

p. 4

Twin Nozzle



KQ2LU, KQ2U
+ KN-Q□A

p. 11

Pivoting Nozzle



KNK Series

p. 14

Flexible Nozzle



KN-X1567

No

No

Fine adjustment of blowing
direction and nozzle position

Yes

3 Water droplets, etc. after cleaning



p. 4

Bar Type

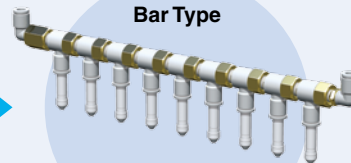

KQ2VF + KN-Q□A

Caution

The applications described here are for reference only. For actual usage in various other applications, please conduct thorough evaluation and validation testing in order to determine the feasibility under your actual usage conditions.

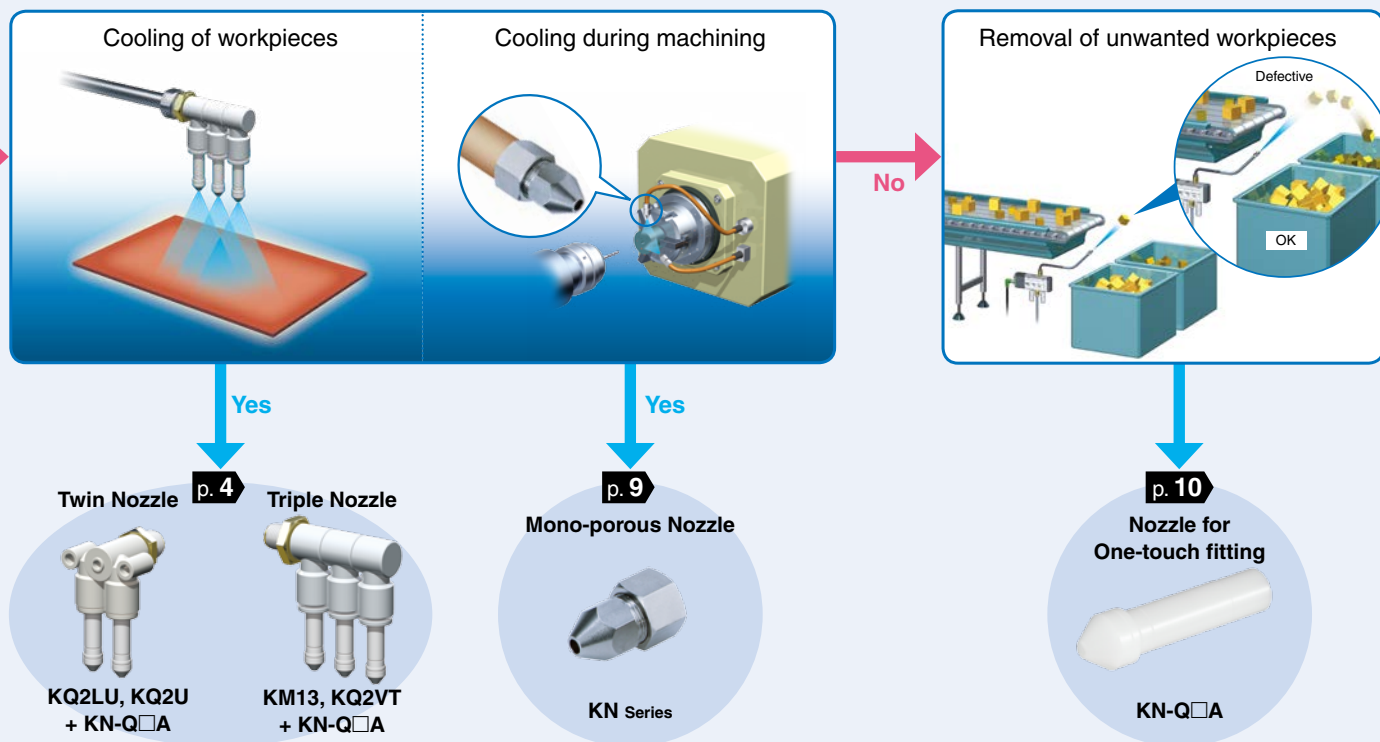

Others

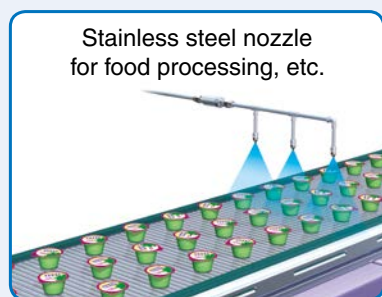

Reduce noise when blowing



Use safety related products (Compliant with OSHA Standards)
 * Operate at 0.5 MPa or less.



Caution The applications described here are for reference only. For actual usage in various other applications, please conduct thorough evaluation and validation testing in order to determine the feasibility under your actual usage conditions.

Related Products **p. 16**

High-flow blow can be performed.

Vacuum Flow ZH-X249

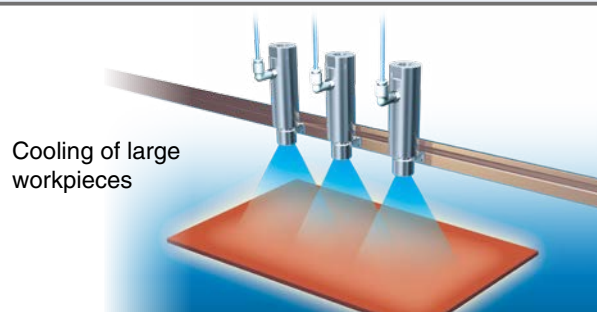

Nozzle Variations

High-pressure blow with minimal pressure loss

p. 9

Mono-porous Nozzle

KN Series

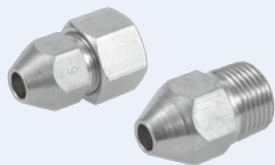

- Pressure loss is significantly reduced and increasing efficiency by implementing a design that uses a large conductance until just before the nozzle outlet.
- This enables a high-pressure blow with minimal pressure loss.
- Connection type: Self-align fitting, Male thread
- Nozzle cover (p. 12)

Nozzle diameter | $\varnothing 1, \varnothing 1.5, \varnothing 2, \varnothing 2.5, \varnothing 3, \varnothing 3.5, \varnothing 4, \varnothing 6$
 $\varnothing 1, \varnothing 1.5, \varnothing 2, \varnothing 2.5, \varnothing 4, \varnothing 6, \varnothing 8$

Blow example

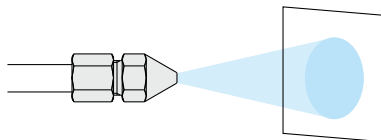

Nozzle length: 300 mm, 600 mm

p. 10

Copper Extension Nozzle

KNL Series

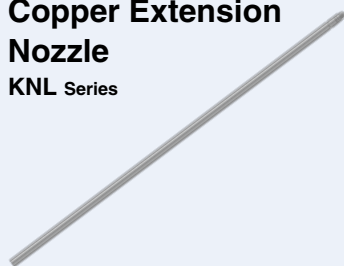

- Secluded and difficult to reach areas
- Blowing at high places, etc.
- With fitting (p. 10)
- Nozzle cover (p. 12)

Nozzle diameter | $\varnothing 1.5, \varnothing 2, \varnothing 2.5, \varnothing 3$

Blow example

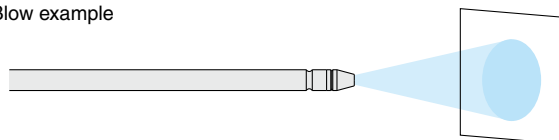

Fine adjustment of blow

p. 11

Pivoting Nozzle

KNK Series

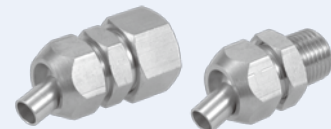

- The pivoting construction of the tip enables fine adjustment of the nozzle direction after setting.
- Connection type: Self-align fitting, Male thread

Nozzle diameter | $\varnothing 4, \varnothing 6$

Blow example

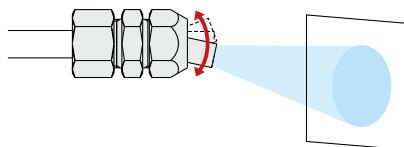

High impact pressure and large flow rate, Compliant with OSHA Standards

p. 11

High Efficiency Nozzle

KNH Series

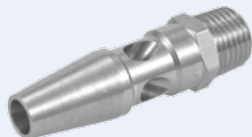

- Entrain the surrounding air increasing the blow flow rate through the nozzle
- Increases the blow flow to about double the supply air quantity
- This nozzle prevents any pressure buildup when the outlet is blocked for safety. (Compliant with OSHA Standards: Operate at 0.5 MPa or less.)

Nozzle diameter | $\varnothing 1, \varnothing 1.5, \varnothing 2$

Blow example

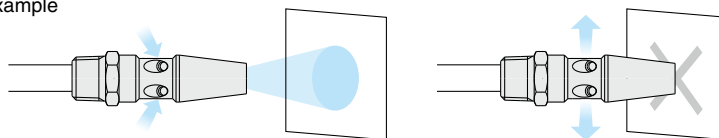

Compliant with OSHA Standards:
Air is discharged from the ports on the side of the product to prevent pressure building up when the outlet of the nozzle tip is blocked.

Noise reduction

p. 11

Low Noise Nozzle

KNS Series

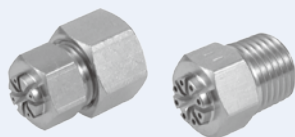

- Small-diameter multi-hole structure to reduce noise and provide a large blow flow rate
- Connection type: Self-align fitting, Male thread

Nozzle diameter | $\varnothing 0.75 \times 4, \varnothing 1 \times 4, \varnothing 0.9 \times 8$
 $\varnothing 0.75 \times 4, \varnothing 1 \times 4, \varnothing 0.9 \times 8, \varnothing 1.1 \times 8$

Blow example

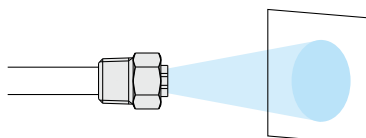

Nozzle Variations

Adjustable layout to match application

Nozzle for One-touch Fitting/Resin Type KN-Q□A

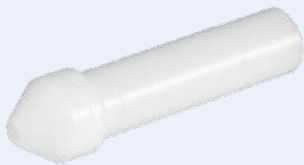

- Nozzle that fit One-touch fittings can be used to setup different blow system layouts.
- Uses highly efficient single hole nozzle to ensure high impact pressure.
- The nozzle diameter can be selected to change the impact pressure on the workpiece.
- This combination variation allows a significant reduction of air consumption by blowing an area wider than a comb-shaped nozzle.

| | |
|-----------------------------------|------------------------|
| Nozzle diameter | ø1, ø1.5, ø2, ø2.5, ø3 |
| Applicable One-touch fitting size | ø6, ø8, ø10, ø12 |

Mounting examples * The nozzle size can be changed.



“Twin Nozzle”

Jet shape



Nozzle for One-touch fitting/
Resin type

KN-Q□A

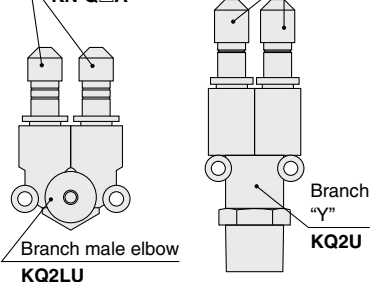

“Triple Nozzle”

Jet shape



Nozzle for One-touch fitting/
Resin type

KN-Q□A

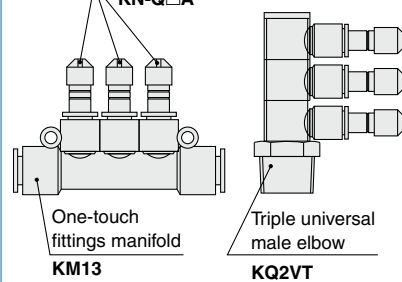

“High-thrust Type”

Jet shape



Nozzle for One-touch fitting/
Resin type

KN-Q□A

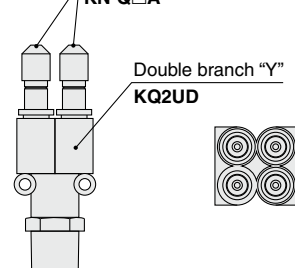

“Water-resistant Type”

Jet shape



Fitting: Stainless steel 316, Nozzle: POM
Nozzle for One-touch fitting/
Resin type

KN-Q□A

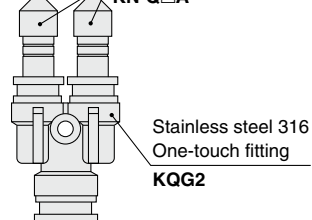

* Stainless steel products are available for heat resistance and anti-corrosion properties. Please contact SMC for further details.

“Bar Type Nozzle”

Jet shape

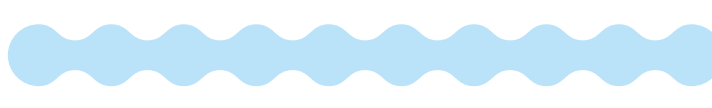

Nozzle for One-touch fitting/
Resin type

KN-Q□A

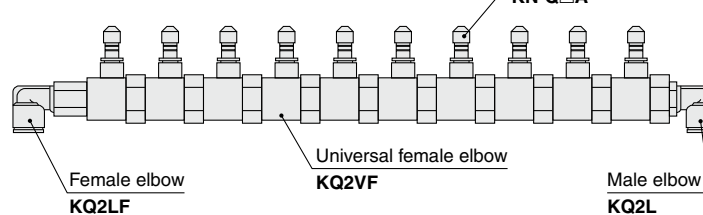

Caution The use of fittings not manufactured by SMC is extremely dangerous since the nozzle for One-touch fitting may be released with no warning. Make sure to purchase the One-touch fitting KQ2 series by SMC and use it in combination with the nozzle. For details on fittings, refer to the [Web Catalog](#).

Nozzle Variations

Made to Order

For blowers

p. 13

Blower Nozzle KN-R03-400-X1484

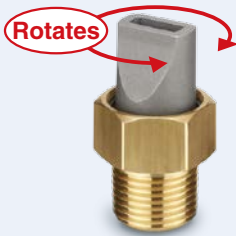

- The spray direction can be adjusted.
- Spray: Fan shape

| | |
|-------------------|--------|
| Nozzle port size | 4 x 11 |
| Connection thread | R3/8 |

Blow example

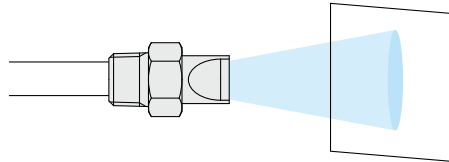

The nozzle position can be rotated after mounting.

p. 14

Bender Tube KN-06-150-X1567



- The nozzle position can be easily adjusted by using a flexible tube.
- The tube can be cut in any length.

| | |
|-------------------|--------|
| Nozzle diameter | ø1.5 |
| Connection thread | R1/8 |
| Tube length | 300 mm |

Blow example

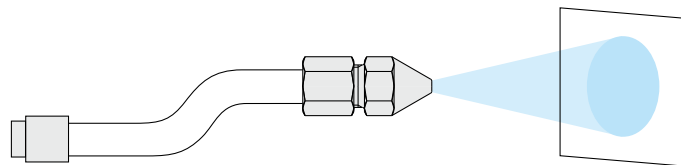

Improved corrosion resistance, heat resistance, and chemical resistance

p. 15

Stainless Steel Nozzles

- Use stainless steel nozzles for excellent anti-corrosion and chemical resistance properties
- Can be used in environments where contact with water or chemicals occurs

| | |
|----------|--|
| Material | Stainless steel 303, Stainless steel 304 |
|----------|--|

| | With self-align fitting | Nozzle with male thread | Pivoting nozzle with male thread | High efficiency | High noise reduction | 2-port nozzle | 3-port nozzle |
|------------------------|-------------------------|-------------------------|----------------------------------|-----------------|----------------------|---------------|---------------|
| Applicable tubing O.D. | ø6 | R1/8, R1/4 | R1/4 | R1/4 | R1/4 | R1/8 | R1/4 |
| Nozzle dia. | ø2.0 | ø1.5, ø2.5 | ø2.0 | ø2.0 | ø1.1 x 8 | ø1.5 x 2 | ø1.5 x 3 |

Related Products

High-flow blow can be performed.

p. 16

Vacuum Flow (ZH) ZH Series



- Entrain the surrounding air increasing the blow flow rate through the nozzle
- Increases the blow flow to about 2 to 4 times the supply air quantity





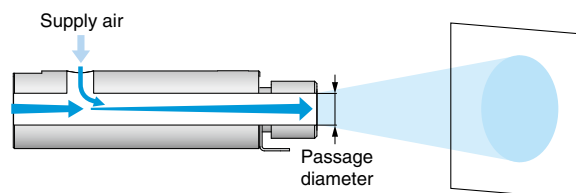

| | |
|------------------------|----------------|
| Fluid passage diameter | ø8, ø11.5, ø12 |
|------------------------|----------------|



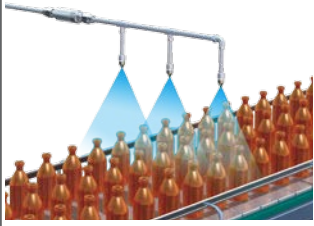

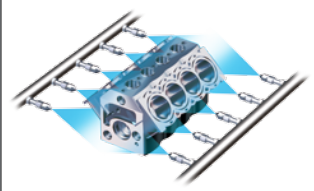
Blow example

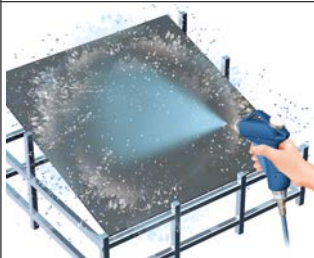

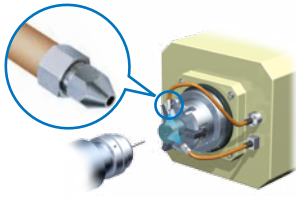

Applications



Nozzles for Blowing

| Work process | Application example | Main series |
|--|---|---|
| Bottle cleaning |  High-pressure blow with minimal pressure loss Adjustable layout to match application | KN-Q□A p. 10  |
| Blowing water droplets off engine blocks |  High-pressure blow with minimal pressure loss Adjustable layout to match application Fine adjustment of blow | KN KNK KN-Q□A p. 9 to 11  |
| Water droplet removal |  Water droplet removal | KNK p. 11  |

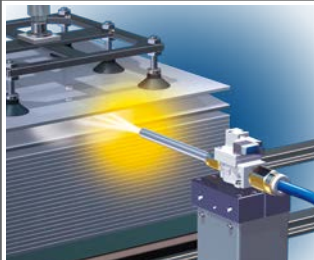



| Work process | Application example | Main series |
|---------------------------------------|--|--|
| Cooling during machining |  | KN p. 9  |
| Blowing for deburring after machining |  | KN p. 9  |



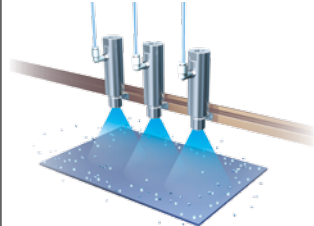

Nozzles for Impact Blow Guns/Blow Valves

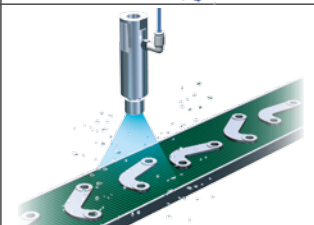
| Work process | Application example | Main series |
|--|---|---|
| Blowing for separating laminated sheet |  Blowing for separating laminated sheet | IBG1-12-10-□   |

| Work process | Application example | Main series |
|--------------------------------------|--|---|
| Blowing for cleaning after machining |  Blowing for cleaning after machining | IBG1-12-10-□   |

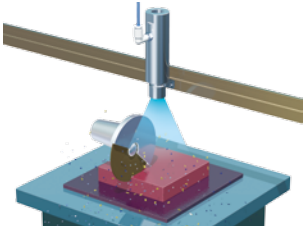
Related Products Vacuum Flow

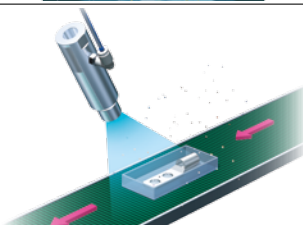
| Work process | Application example | Main series |
|--|---|--|
| Pre-cleaning surfaces |  Pre-cleaning surfaces | ZH-X249 p. 16  |
| Removal of foreign matter on the surface |  Removal of foreign matter on the surface | ZH-X249 p. 16  |

| Work process | Application example | Main series |
|--|--|--|
| Removal of machining chips during shearing |  Removal of machining chips during shearing | ZH-X249 p. 16  |
| Blowing away machining chips |  Blowing away machining chips | ZH-X249 p. 16  |



Caution The applications described here are for reference only. For actual usage in various other applications, please conduct thorough evaluation and validation testing in order to determine the feasibility under your actual usage conditions.

Jet Shape and Impact Pressure Distribution Diagram

Nozzle with Self-align Fitting KN Series Copper Extension Nozzle KNL Series **p. 9, 10**

- Standard blow nozzle
- Highly effective with low pressure loss
- A wide variety of nozzle diameters are available for selection.
- Can be used with One-touch fittings, copper piping, and other applications in addition to mounting on male and female threads

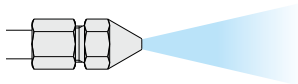

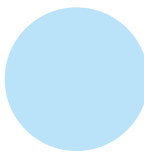
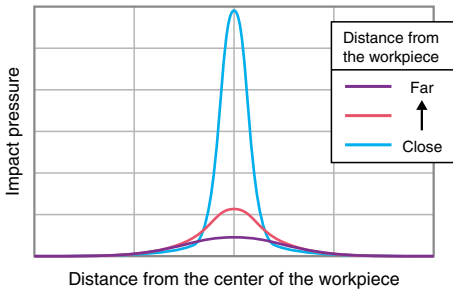
| Jet shape | Pressure distribution diagram (Image) | Main applications |
|--|--|---------------------------|
|  <p>Distance from the workpiece: 100 mm</p> |  | General air blow purposes |

High Efficiency Nozzle KNH Series **p. 11**

- Entrain the surrounding air and increases the blow flow rate
- Blow thrust improved by 10%
- OSHA Standards compliant product (Operate at 0.5 MPa or less.)

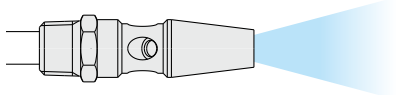

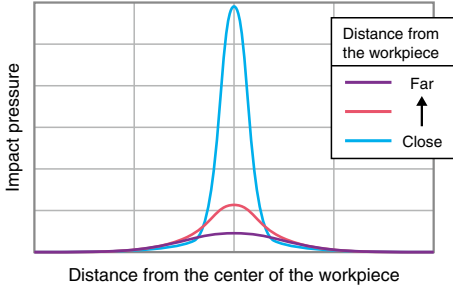
| Jet shape | Pressure distribution diagram (Image) | Main applications |
|---|---|---------------------------|
|  <p>Distance from the workpiece: 100 mm</p> |  | General air blow purposes |

Branch Male Elbow + Nozzle for One-touch Fitting/Resin Type KQ2LU + KN-Q□A (2 pcs.) **p. 4**

- A type with two nozzles (resin type) for One-touch fitting inserted in a branch elbow
- Can be used for blowing a wide area
- Provides high impact pressure and a jet shape similar to a general comb-shaped nozzle
- Low air consumption (Compared to a comb-shaped nozzle)

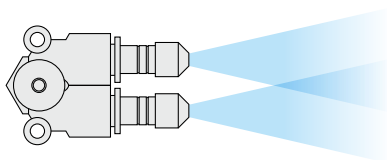

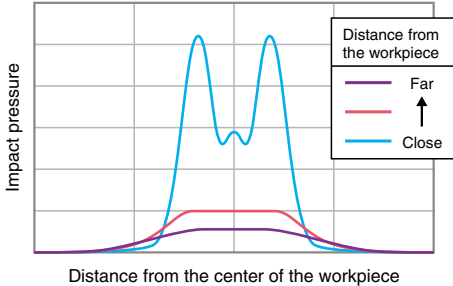
| Jet shape | Pressure distribution diagram (Image) | Main applications |
|--|--|--|
|  <p>Distance from the workpiece: 100 mm</p> |  | Blowing off of water droplets Removal of defective workpieces Drying Removal of foreign matter Blowing water droplets off engine blocks Workpiece alignment |

Jet Shape and Impact Pressure Distribution Diagram

One-touch Fittings Manifold + Nozzle for One-touch Fitting/ Resin Type

KM13 + KN-Q□A (3 pcs.)

p. 4

- Nozzle for One-touch fittings / resin type One-touch fittings manifold docking stations
- Optimum for blowing water, or other fluids off, a wide area
- For impact pressure and blowing area greater than a general comb-shaped nozzle!

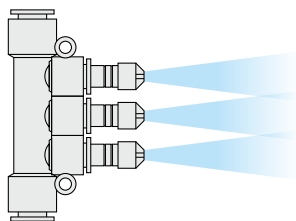

| Jet shape | Pressure distribution diagram (Image) | Main applications |
|--|---------------------------------------|---|
| <p>Distance from the workpiece: 100 mm</p> | | <p>Blowing off the water of a wide area</p> <p>Drying</p> <p>Removal of foreign matter</p> <p>Cooling</p> |

Low Noise Nozzle with Self-align Fitting

KNS Series p. 11

- Designed to blow with 4 to 8 nozzles and high noise reduction. Can be used for a smaller area

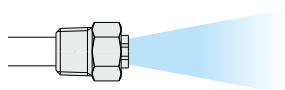

| Jet shape | Pressure distribution diagram (Image) | Main applications |
|---|---------------------------------------|--|
| <p>Distance from the workpiece: 50 mm</p> | | <p>Drying, Blowing off of water droplets</p> <p>Cooling: Highly precise cooling of resin-molded articles</p> |

Nozzles for Blowing

KN Series



Specifications

Nozzle (KN, KNK, KNH, KNS, KNL)

| | | |
|--------------------------------|--|---------------------------------------|
| Applicable tubing material | Nylon, Soft nylon, Flexible copper pipe (C1220T-O), OST pipe | |
| Applicable tubing O.D. | ø4, ø6, ø8, ø10, ø12, ø16, ø20 | |
| Fluid | Air, Coolant*1 | |
| Max. operating pressure | 1 MPa (0.3 MPa with OST pipe) | |
| Ambient and fluid temperatures | -5 to 60°C (No freezing) | |
| Threads | Mounting | JIS B 0203 (Taper threads for piping) |
| | Nut | JIS B 0205 (Metric fine thread) |
| Seal on the threads | None | |
| Copper-free (Standard) | Brass parts are all electroless nickel plated. | |

*1 Excludes the KNS and KN-Q□A

Principal Parts Material

KN, KNK, KNH, KNS

| | |
|----------------------------------|---------------------|
| Body, Nut | C3604 |
| Sleeve (Self-align fitting type) | C2700 |
| Nozzle (Pivoting type) | Stainless steel 303 |

KNL

| | |
|--------|----------|
| Pipe | C1220T-0 |
| Nozzle | C3604 |

Nozzle with self-align fitting/KN

[mm]



| Model | Nozzle dia. øD | Applicable tubing O.D. | Width across flats | | L ₁ | M | Weight [g] |
|-----------|-------------------|------------------------|--------------------|----------------|----------------|----|------------|
| | | | H ₁ | H ₂ | | | |
| KN-04-100 | ø1 | ø4 | 10 | 10 | 27 | 15 | 13 |
| KN-04-150 | ø1.5 | ø4 | 10 | 10 | 27.7 | 15 | 14 |
| KN-06-100 | ø1 | ø6 | 12 | 12 | 30.1 | 16 | 19 |
| KN-06-150 | ø1.5 | ø6 | 12 | 12 | 30.8 | 16 | 20 |
| KN-06-200 | ø2 | ø6 | 12 | 12 | 31.5 | 16 | 22 |
| KN-08-150 | ø1.5 | ø8 | 14 | 14 | 33.8 | 16 | 28 |
| KN-08-200 | ø2 | ø8 | 14 | 14 | 34.6 | 16 | 30 |
| KN-10-250 | ø2.5 | ø10 | 14 | 17 | 35.6 | 17 | 35 |
| KN-10-300 | ø3 | ø10 | 14 | 17 | 36.3 | 17 | 36 |
| KN-10-350 | ø3.5 | ø10 | 14 | 17 | 37.1 | 17 | 37 |
| KN-10-400 | ø4 | ø10 | 14 | 17 | 29.5 | 17 | 30 |
| KN-10-600 | ø6 | ø10 | 14 | 17 | 27.7 | 17 | 28 |
| KN-12-350 | ø3.5 | ø12 | 17 | 19 | 40.4 | 17 | 54 |
| KN-12-400 | ø4 | ø12 | 17 | 19 | 41.3 | 17 | 55 |
| KN-12-600 | ø6 | ø12 | 17 | 19 | 31.2 | 17 | 40 |
| KN-16-400 | ø4 | ø16 | 22 | 24 | 40.1 | 17 | 77 |
| KN-16-600 | ø6 | ø16 | 22 | 24 | 38.4 | 17 | 79 |
| KN-20-400 | ø4 | ø20 | 26 | 27 | 45.6 | 17 | 117 |
| KN-20-600 | ø6 | ø20 | 26 | 27 | 43.9 | 17 | 112 |

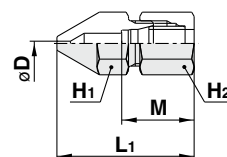

Nozzle with male thread/KN

[mm]



| Model | Nozzle dia. øD | Connection thread | Width across flats | L ₁ | A*1 | Weight [g] |
|------------|-------------------|-------------------|--------------------|----------------|------|------------|
| | | | H ₁ | | | |
| KN-R01-100 | ø1 | R1/8 | 10 | 21.4 | 17.4 | 8 |
| KN-R01-150 | ø1.5 | R1/8 | 10 | 21 | 17 | 8 |
| KN-R02-100 | ø1 | R1/4 | 14 | 31.4 | 25.4 | 19 |
| KN-R02-150 | ø1.5 | R1/4 | 14 | 31 | 25 | 20 |
| KN-R02-200 | ø2 | R1/4 | 14 | 30.5 | 24.5 | 21 |
| KN-R02-250 | ø2.5 | R1/4 | 14 | 30.1 | 24.1 | 21 |
| KN-R02-600 | ø6 | R1/4 | 14 | 27.1 | 21.1 | 22 |
| KN-R03-400 | ø4 | R3/8 | 17 | 31.8 | 25.4 | 36 |
| KN-R03-600 | ø6 | R3/8 | 17 | 30.1 | 23.7 | 37 |
| KN-R04-400 | ø4 | R1/2 | 22 | 41.8 | 33.6 | 75 |
| KN-R04-600 | ø6 | R1/2 | 22 | 40.1 | 31.8 | 76 |
| KN-R06-600 | ø6 | R3/4 | 27 | 49.6 | 40.1 | 149 |
| KN-R06-800 | ø8 | R3/4 | 27 | 47.8 | 38 | 152 |
| KN-R10-800 | ø8 | R1 | 36 | 62.8 | 52.4 | 328 |

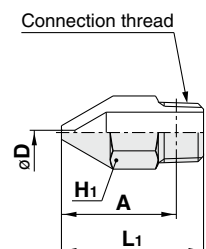

*1 Reference dimensions after R thread installation

Copper extension nozzle/KNL

[mm]

| Model | Nozzle dia. ϕD | Outside diameter | L ₁ | Weight [g] |
|-------------|----------------------|------------------|----------------|------------|
| KNL3-06-150 | $\phi 1.5$ | $\phi 6$ | 300 | 43 |
| KNL3-06-200 | $\phi 2$ | $\phi 6$ | 300 | 43 |
| KNL3-08-200 | $\phi 2$ | $\phi 8$ | 300 | 61 |
| KNL3-08-250 | $\phi 2.5$ | $\phi 8$ | 300 | 61 |
| KNL3-10-250 | $\phi 2.5$ | $\phi 10$ | 300 | 94 |
| KNL3-10-300 | $\phi 3$ | $\phi 10$ | 300 | 94 |
| KNL6-06-150 | $\phi 1.5$ | $\phi 6$ | 600 | 84 |
| KNL6-06-200 | $\phi 2$ | $\phi 6$ | 600 | 84 |
| KNL6-08-200 | $\phi 2$ | $\phi 8$ | 600 | 117 |
| KNL6-08-250 | $\phi 2.5$ | $\phi 8$ | 600 | 117 |
| KNL6-10-250 | $\phi 2.5$ | $\phi 10$ | 600 | 183 |
| KNL6-10-300 | $\phi 3$ | $\phi 10$ | 600 | 183 |

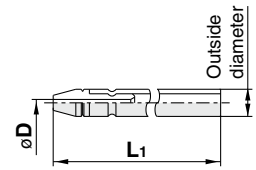

Copper extension nozzle set/VMG

[mm]

| Model | Nozzle dia. D | Outside diameter | L ₁ | L ₂ * ¹ | L* ¹ | Width across flats | | | | | | | | | | | | | | | | | | | | | | | | | | | | | |
|-----------------|-----------------|------------------|----------------|-------------------------------|-----------------|--------------------|----------|-----|-----|-----|-----|-----|-----|-----|-----|-----|-----|-----|-----|----|-----|-----|-----|-----|-----|-----|-----|-----|-----|-----|-----|-----|-----|-----|-----|
| | | | | | | H ₁ | | | | | | | | | | | | | | | | | | | | | | | | | | | | | |
| VMG1-06-150-100 | $\phi 1.5$ | $\phi 6$ | 100 | 100 | 106 | 12 | | | | | | | | | | | | | | | | | | | | | | | | | | | | | |
| VMG1-06-200-100 | $\phi 2$ | | 150 | 150 | 156 | | | | | | | | | | | | | | | | | | | | | | | | | | | | | | |
| VMG1-06-150-150 | $\phi 1.5$ | | | | | | 300 | 300 | 306 | | | | | | | | | | | | | | | | | | | | | | | | | | |
| VMG1-06-200-150 | $\phi 2$ | | | | | | | | | 600 | 600 | 606 | | | | | | | | | | | | | | | | | | | | | | | |
| VMG1-06-150-300 | $\phi 1.5$ | | | | | | | | | | | | 100 | 100 | 106 | | | | | | | | | | | | | | | | | | | | |
| VMG1-06-200-300 | $\phi 2$ | | | | | | | | | | | | | | | 150 | 150 | 156 | | | | | | | | | | | | | | | | | |
| VMG1-06-150-600 | $\phi 1.5$ | 300 | | | | 300 | | | | | | | | | | | | | 306 | | | | | | | | | | | | | | | | |
| VMG1-06-200-600 | $\phi 2$ | | 600 | 600 | 606 | | | | | | | | | | | | | | | | | | | | | | | | | | | | | | |
| VMG1-08-250-100 | $\phi 2.5$ | | | | | | $\phi 8$ | 100 | 106 | | | | | | | | | | | 14 | | | | | | | | | | | | | | | |
| VMG1-08-300-100 | $\phi 3$ | | | | | | | | | 150 | 150 | 156 | | | | | | | | | | | | | | | | | | | | | | | |
| VMG1-08-350-100 | $\phi 3.5$ | | | | | | | | | | | | 300 | 300 | 306 | | | | | | | | | | | | | | | | | | | | |
| VMG1-08-250-150 | $\phi 2.5$ | | | | | | | | | | | | | | | 600 | 600 | 606 | | | | | | | | | | | | | | | | | |
| VMG1-08-300-150 | $\phi 3$ | 100 | | | | 100 | | | | | | | | | | | | | 106 | | | | | | | | | | | | | | | | |
| VMG1-08-350-150 | $\phi 3.5$ | | 150 | 150 | 156 | | | | | | | | | | | | | | | | | | | | | | | | | | | | | | |
| VMG1-08-250-300 | $\phi 2.5$ | | | | | | | | | | | | | | | | | | | | 300 | 300 | 306 | | | | | | | | | | | | |
| VMG1-08-300-300 | $\phi 3$ | | | | | | | | | | | | | | | | | | | | | | | 600 | 600 | 606 | | | | | | | | | |
| VMG1-08-350-300 | $\phi 3.5$ | | | | | | | | | | | | | | | | | | | | | | | | | | 100 | 100 | 106 | | | | | | |
| VMG1-08-250-600 | $\phi 2.5$ | | | | | | | | | | | | | | | | | | | | | | | | | | | | | 150 | 150 | 156 | | | |
| VMG1-08-300-600 | $\phi 3$ | | | | | | | | | | | | | | | | | | | | | | | | | | | | | | | | 300 | 300 | 306 |
| VMG1-08-350-600 | $\phi 3.5$ | | | | | | | | | | | | | | | | | | | | | | | | | | | | | | | | | | |

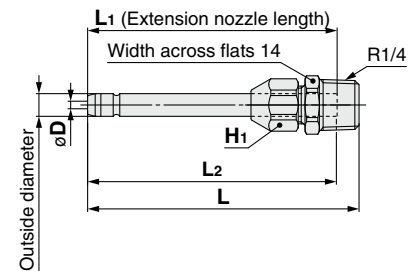

*¹ Reference dimensions after installation
 * Copper extension nozzle and self-align fitting are included in the same package but do not come assembled. Refer to "How to attach extension nozzle" in the VMG series operation manual for assembly procedures.

Nozzle for One-touch fitting (Resin type)/KN-Q□A

[mm]

| Model | Nozzle dia. ϕD | Applicable fitting size ϕd | L ₁ | A* ¹ | Weight [g] |
|-------------|----------------------|----------------------------------|----------------|-----------------|------------|
| KN-Q06A-100 | $\phi 1$ | $\phi 6$ | 35 | 21.8 | 1 |
| KN-Q06A-150 | $\phi 1.5$ | $\phi 6$ | 35 | 21.8 | 1 |
| KN-Q06A-200 | $\phi 2$ | $\phi 6$ | 35 | 21.8 | 1 |
| KN-Q08A-150 | $\phi 1.5$ | $\phi 8$ | 39 | 24.8 | 2 |
| KN-Q08A-200 | $\phi 2$ | $\phi 8$ | 39 | 24.8 | 2 |
| KN-Q10A-200 | $\phi 2$ | $\phi 10$ | 43 | 27.4 | 3 |
| KN-Q10A-250 | $\phi 2.5$ | $\phi 10$ | 43 | 27.4 | 3 |
| KN-Q12A-250 | $\phi 2.5$ | $\phi 12$ | 45.5 | 28.5 | 4 |
| KN-Q12A-300 | $\phi 3$ | $\phi 12$ | 45.5 | 28.5 | 4 |

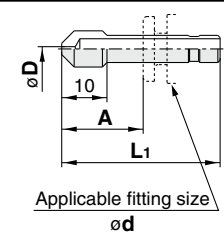

*¹ Dimensions shown are for nozzle connected to the KQ2 series.

⚠ Warning [Mounting / Piping] Applicable nozzle: Nozzle for One-touch fitting (Resin/Metal type)
 When connecting the nozzle to the One-touch fitting, insert it securely until it cannot move any further. After setting the nozzle deep into the fitting, be sure to pull on the nozzle to confirm that it is firm and does not budge. If the nozzle is not secured all the way at the back of the fitting or if there is insufficient engagement with the One-touch fitting, the nozzle may dislodge during pressurization, which is dangerous and may result in injury or accident.

Nozzle for One-touch fitting (Metal type)/KN-Q□

[mm]

| Model | Nozzle dia. ϕD | Applicable fitting size ϕd | L ₁ | A | Weight [g] |
|------------|----------------------|----------------------------------|----------------|------|------------|
| KN-Q06-100 | $\phi 1$ | $\phi 6$ | 35 | 18 | 5 |
| KN-Q06-150 | $\phi 1.5$ | $\phi 6$ | 35 | 18 | 5 |
| KN-Q06-200 | $\phi 2$ | $\phi 6$ | 35 | 18 | 5 |
| KN-Q08-150 | $\phi 1.5$ | $\phi 8$ | 39 | 20.5 | 9 |
| KN-Q08-200 | $\phi 2$ | $\phi 8$ | 39 | 20.5 | 9 |
| KN-Q10-200 | $\phi 2$ | $\phi 10$ | 43 | 22 | 16 |
| KN-Q10-250 | $\phi 2.5$ | $\phi 10$ | 43 | 22 | 16 |
| KN-Q12-250 | $\phi 2.5$ | $\phi 12$ | 45.5 | 24 | 23 |
| KN-Q12-300 | $\phi 3$ | $\phi 12$ | 45.5 | 24 | 23 |

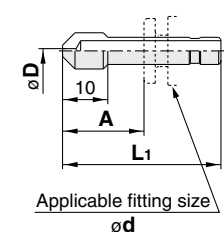

Connecting products with metal rods
 Products with metal rods cannot be connected to the KQ2 series One-touch fittings (Available as a special order). If connected, the metal rod cannot be retained by the chuck of the One-touch fitting and products with metal rods may project during pressurization, causing serious personal injury or accident. For details about One-touch fittings that can connect products with metal rods, contact SMC.

KN Series

Pivoting nozzle with self-align fitting/KNK

[mm]



| Model | Nozzle dia. øD | Applicable tubing O.D. | Width across flats | | L ₁ | M | Weight [g] |
|------------|-------------------|------------------------|--------------------|----------------|----------------|----|------------|
| | | | H ₁ | H ₂ | | | |
| KNK-10-400 | ø4 | ø10 | 17 | 17 | 41.7 | 17 | 44 |
| KNK-10-600 | ø6 | ø10 | 17 | 17 | 41.7 | 17 | 44 |
| KNK-12-400 | ø4 | ø12 | 17 | 19 | 41.2 | 17 | 44 |
| KNK-12-600 | ø6 | ø12 | 17 | 19 | 41.2 | 17 | 44 |
| KNK-16-400 | ø4 | ø16 | 17 | 24 | 41.8 | 17 | 64 |
| KNK-16-600 | ø6 | ø16 | 17 | 24 | 41.8 | 17 | 64 |
| KNK-20-400 | ø4 | ø20 | 17 | 27 | 43.8 | 17 | 77 |
| KNK-20-600 | ø6 | ø20 | 17 | 27 | 43.8 | 17 | 77 |

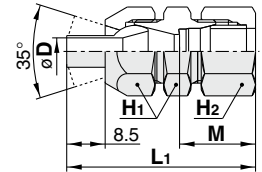

Pivoting nozzle with male thread/KNK

[mm]



| Model | Nozzle dia. øD | Connection thread | Width across flats | | L ₁ | A* ₁ | Weight [g] |
|-------------|-------------------|-------------------|--------------------|----------------|----------------|-----------------|------------|
| | | | H ₁ | H ₂ | | | |
| KNK-R02-400 | ø4 | R1/4 | 17 | 17 | 38 | 31.9 | 32 |
| KNK-R02-600 | ø6 | R1/4 | 17 | 17 | 38 | 31.9 | 32 |
| KNK-R03-400 | ø4 | R3/8 | 17 | 17 | 39 | 32.4 | 40 |
| KNK-R03-600 | ø6 | R3/8 | 17 | 17 | 39 | 32.4 | 40 |
| KNK-R04-400 | ø4 | R1/2 | 17 | 22 | 42.2 | 34.1 | 54 |
| KNK-R04-600 | ø6 | R1/2 | 17 | 22 | 42.2 | 34.1 | 54 |

*1 Reference dimensions after R thread installation

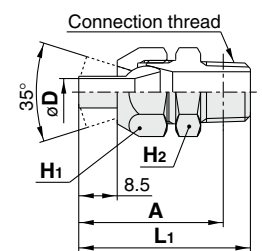

High efficiency nozzle/KNH (OSHA compliant: Operate at 0.5 MPa or less.)

[mm]

Amplifies the air blow flow rate (When operated at 0.5 MPa: amplifies by 2 to 3 times)



| Model | Nozzle dia. øD | Connection thread | Width across flats | L ₁ | A* ₁ | Weight [g] |
|-------------|-------------------|-------------------|--------------------|----------------|-----------------|------------|
| | | | H ₁ | | | |
| KNH-R02-100 | ø1 | R1/4 | 14 | 52 | 46 | 38 |
| KNH-R02-150 | ø1.5 | R1/4 | 14 | 52 | 46 | 38 |
| KNH-R02-200 | ø2 | R1/4 | 14 | 52 | 46 | 38 |

*1 Reference dimensions after R thread installation

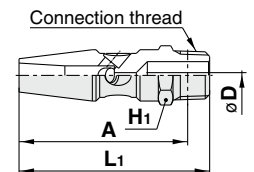

Low noise nozzle with self-align fitting/KNS

[mm]



| Model | Nozzle dia. øD | Applicable tubing O.D. | Width across flats | | L ₁ | M | Weight [g] |
|--------------|-------------------|------------------------|--------------------|----------------|----------------|----|------------|
| | | | H ₁ | H ₂ | | | |
| KNS-08-075-4 | ø0.75 x 4 | ø8 | 12 | 14 | 24.3 | 16 | 17 |
| KNS-08-100-4 | ø1 x 4 | ø8 | 12 | 14 | 24.3 | 16 | 17 |
| KNS-10-075-4 | ø0.75 x 4 | ø10 | 14 | 17 | 24 | 17 | 24 |
| KNS-10-090-8 | ø0.9 x 8 | ø10 | 14 | 17 | 24 | 17 | 24 |
| KNS-10-100-4 | ø1 x 4 | ø10 | 14 | 17 | 24 | 17 | 24 |

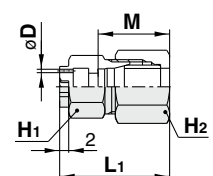

Low noise nozzle with male thread/KNS

[mm]



| Model | Nozzle dia. øD | Connection thread | Width across flats | L ₁ | A* ₁ | Weight [g] |
|---------------|-------------------|-------------------|--------------------|----------------|-----------------|------------|
| | | | H ₁ | | | |
| KNS-R01-075-4 | ø0.75 x 4 | R1/8 | 12 | 18 | 14 | 9 |
| KNS-R01-100-4 | ø1 x 4 | R1/8 | 12 | 18 | 14 | 9 |
| KNS-R01-090-8 | ø0.9 x 8 | R1/8 | 12 | 18 | 14 | 9 |
| KNS-R02-075-4 | ø0.75 x 4 | R1/4 | 14 | 20 | 14 | 13 |
| KNS-R02-090-8 | ø0.9 x 8 | R1/4 | 14 | 20 | 14 | 13 |
| KNS-R02-100-4 | ø1 x 4 | R1/4 | 14 | 20 | 14 | 13 |
| KNS-R02-110-8 | ø1.1 x 8 | R1/4 | 14 | 20 | 14 | 13 |

*1 Reference dimensions after R thread installation

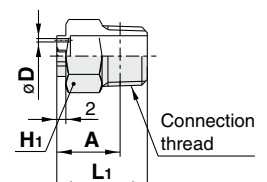

Made to Order
(For details, refer to pages 13 to 15.)

| Description | |
|-------------------------|-------|
| Blower Nozzle | p. 13 |
| Bender Tube | p. 14 |
| Stainless Steel Nozzles | p. 15 |

Sensing Heads

Specifications

Sensing head (KNP)

| | |
|-----------------------------------|--------------------------|
| Applicable tubing O.D. | ø4 |
| Fluid | Air |
| Max. operating pressure (at 20°C) | 0.8 MPa |
| Ambient and fluid temperatures | -5 to 60°C (No freezing) |

Principal Parts Material

KNP-1

| | |
|-----------------------------|--|
| Pressure spindle | Stainless steel 303 |
| One-touch fitting | POM, NBR, Stainless steel 303, Stainless steel 304 |
| Polyurethane tube (ø4, 1 m) | Polyurethane |

KNP-2

| | |
|-----------------------------|-------------------------------|
| Pipe | Stainless steel 304 |
| One-touch fitting | POM, NBR, Stainless steel 304 |
| Polyurethane tube (ø4, 1 m) | Polyurethane |

Standard sensing head/KNP



| Model | Nozzle dia. øD | Applicable tubing O.D. | Width across flats | | M | L ₁ | L ₂ | Weight [g] |
|-------|-------------------|------------------------|--------------------|----------------|------|----------------|----------------|------------|
| | | | H ₁ | H ₂ | | | | |
| KNP-1 | ø2.5 | ø4 | 5 | 8 | 13.3 | 64.6 | 986.7 | 7 |

* A 1 m polyurethane tube is included.

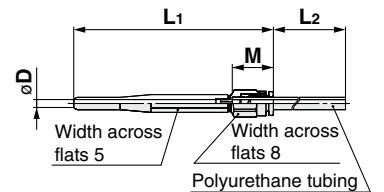

Needle sensing head/KNP



| Model | Nozzle dia. øD | Applicable tubing O.D. | D ₂ | M | L ₁ | L ₂ | L ₃ | Weight [g] |
|-------|-------------------|------------------------|----------------|---|----------------|----------------|----------------|------------|
| | | | | | | | | |

* A 1 m polyurethane tube is included.

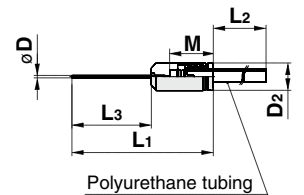

Use to measure workpiece impact pressure.

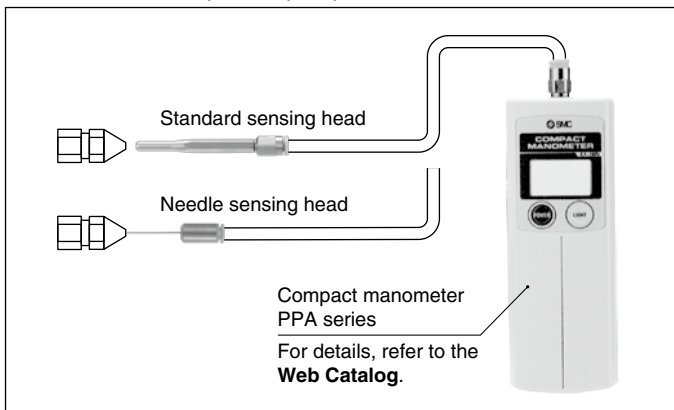

Nozzle Covers

Cover for male thread nozzle

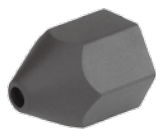

| Nozzle cover model | Material | Applicable blow gun model | |
|--------------------|--------------|---------------------------|-------------------------------|
| | | Model | Nozzle type |
| P5670129-01 | HNBR | VMG1□□-□-01 to 04 | Male thread nozzle ø1 to ø2.5 |
| P5670129-01F | Fluororubber | | |
| P5670129-02 | HNBR | VMG1□□-□-05 to 07 | Male thread nozzle ø3 to ø4 |
| P5670129-02F | Fluororubber | | |

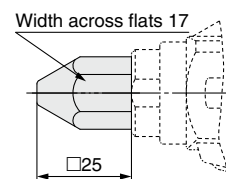

VMG1□□-□-1 to 04

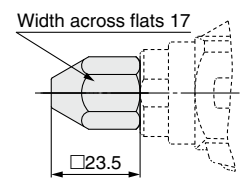

VMG1□□-□-05 to 07

Cover for copper extension nozzle



| Nozzle cover model | Material | Applicable blow gun model | |
|--------------------|--------------|---------------------------|----------------------------|
| | | Model | Nozzle type |
| P5670129-11 | HNBR | VMG1□□-□-31 to 38 | ø6 copper extension nozzle |
| P5670129-11F | Fluororubber | | |

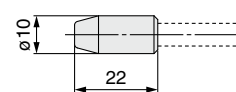

VMG1□□-□-31 to 38

Made to Order

Contact our sales office for delivery dates and prices as this is a special model.



1 Blower Nozzle KN-R03-400-X1484

- The spray direction can be adjusted after the nozzle has been mounted.
- Spray: Fan shape
- Material: Stainless steel (Nozzle)
Brass (Socket: R3/8)

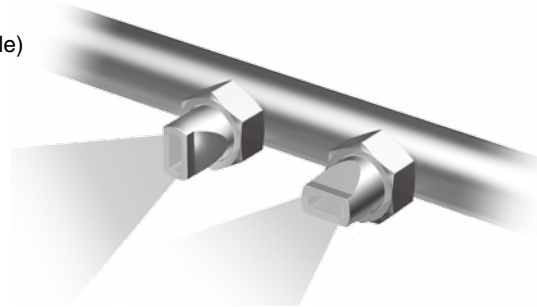

Rotates

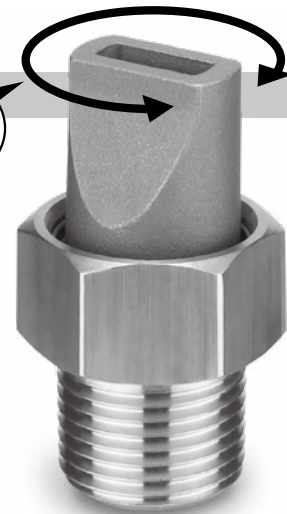

Nozzle Impact Pressure Distribution Diagram

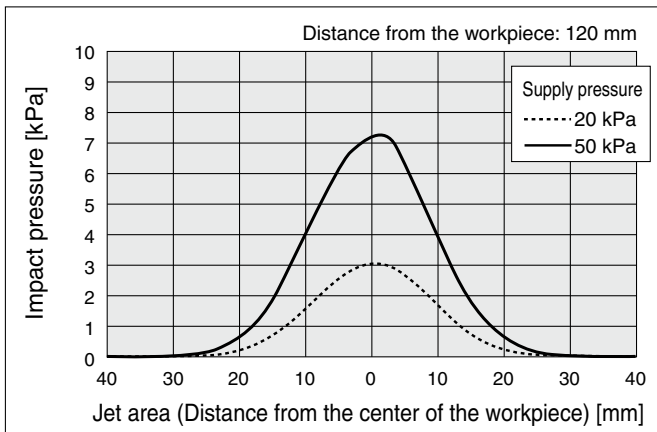

Application Example

For blowing water droplets off engine blocks

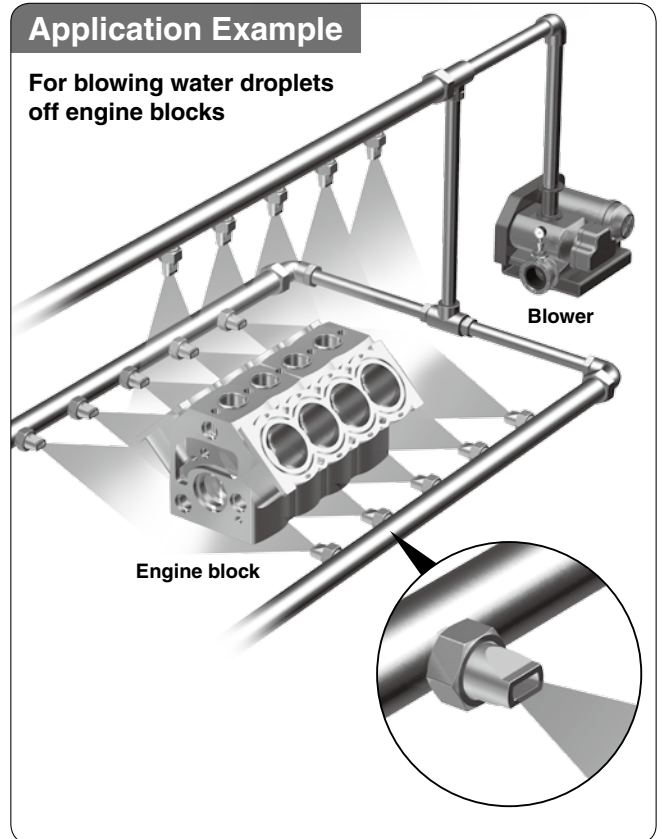

Specifications

| | |
|--------------------------|-----------------|
| Fluid | Air |
| Operating pressure range | 1 MPa or less*1 |
| Fluid temperature | -10 to 60°C |
| Nozzle port size | 4 x 11 |
| Connection thread | R3/8 |
| Weight | 45 g |
| Air source | Blower*1 |
| Spray | Fan shape |

*1 Compressor air can be used.

Dimensions

[mm]

KN-R03-400-X1484

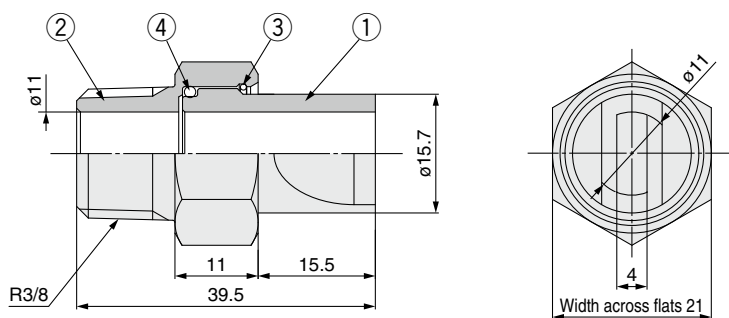

| No. | Description | Material |
|-----|-----------------|-----------------|
| 1 | Nozzle (4 x 11) | Stainless steel |
| 2 | Socket (R3/8) | Brass |
| 3 | Stopper | Stainless steel |
| 4 | O-ring | NBR |

Made to Order

Contact our sales office for delivery dates and prices as this is a special model.



2 Bender Tube KN-06-150-X1567

- A metal bender tube and a single-hole nozzle combined in one unit, which allows the shape to be changed manually
- The nozzle diameter can be selected to adjust the impact pressure on the workpiece.
- Can be cut with a tube cutter (TK series made by SMC)



Dimensions

KN-06-150-X1567

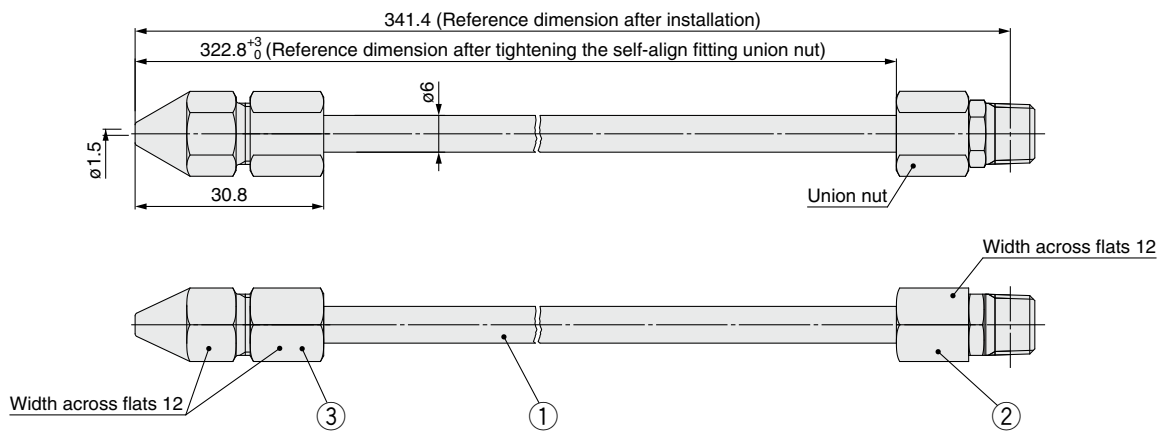

Made to Order

Contact our sales office for delivery dates and prices as this is a special model.



3 Stainless Steel Nozzles

- Use stainless steel nozzles for excellent anti-corrosion and chemical resistance properties
- Can be used in environments where contact with water or chemicals occurs

With male thread

| | |
|-------------------|------|
| Connection thread | R1/8 |
| Nozzle dia. | ø1.5 |

Material:
Stainless steel 303



KN-R01-150-X13

| | |
|-------------------|------|
| Connection thread | R1/4 |
| Nozzle dia. | ø2.5 |

Material:
Stainless steel 303



KN-R02-250-X13

Material:
Stainless steel 304



KN-R02-250-X49

With self-align fitting

| | |
|------------------------|------|
| Applicable tubing O.D. | ø6 |
| Nozzle diameter | ø2.0 |

Material: Stainless steel 303

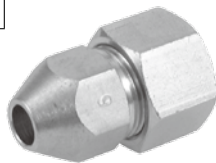

KN06-200-DPI00713

Pivoting nozzle with male thread

| | |
|-------------------|------|
| Connection thread | R1/4 |
| Nozzle dia. | ø2.0 |

Material: Stainless steel 303



KNK-R02-200-X1524

High efficiency

| | |
|-------------------|------|
| Connection thread | R1/4 |
| Nozzle dia. | ø2.0 |

Material:
Stainless steel 303

Material:
Stainless steel 304

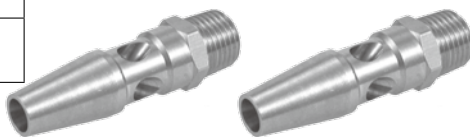

KNH-R02-200-X13

KNH-R02-200-X49

High noise reduction

| | |
|-------------------|----------|
| Connection thread | R1/4 |
| Nozzle dia. | ø1.1 x 8 |

Material: Stainless steel 303



KNS-R02-110-8-X13

2-port/3-port nozzle

| | |
|-------------------|----------|
| Connection thread | R1/8 |
| Nozzle dia. | ø1.5 x 2 |

Material: Stainless steel 304

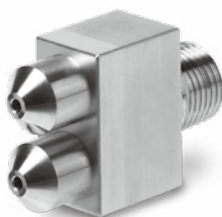

KN-DPW00079

| | |
|-------------------|----------|
| Connection thread | R1/4 |
| Nozzle dia. | ø1.5 x 3 |

Material: Stainless steel 304

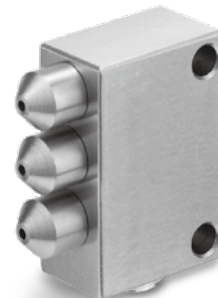

KN-DPZ00022

Please contact SMC for information on size options.

Related Products

Vacuum Flow

ZH-X226/X338/X249

High-flow blow **Max. 1550 L/min (ANR)** and vacuum **Max. 880 L/min (ANR)** can be performed by supplying compressed air.

| Model | L/min (ANR) | | |
|-------------|-------------------|---------------------|-----------------|
| | Suction flow rate | Discharge flow rate | Air consumption |
| ZH-X226 | 405 | 700 | 297 |
| ZH-X338 | 880 | 1550 | 570 |
| ZH10-B-X249 | 820 | 1160 | 340 |

At 0.5 MPa supply pressure

Series Map

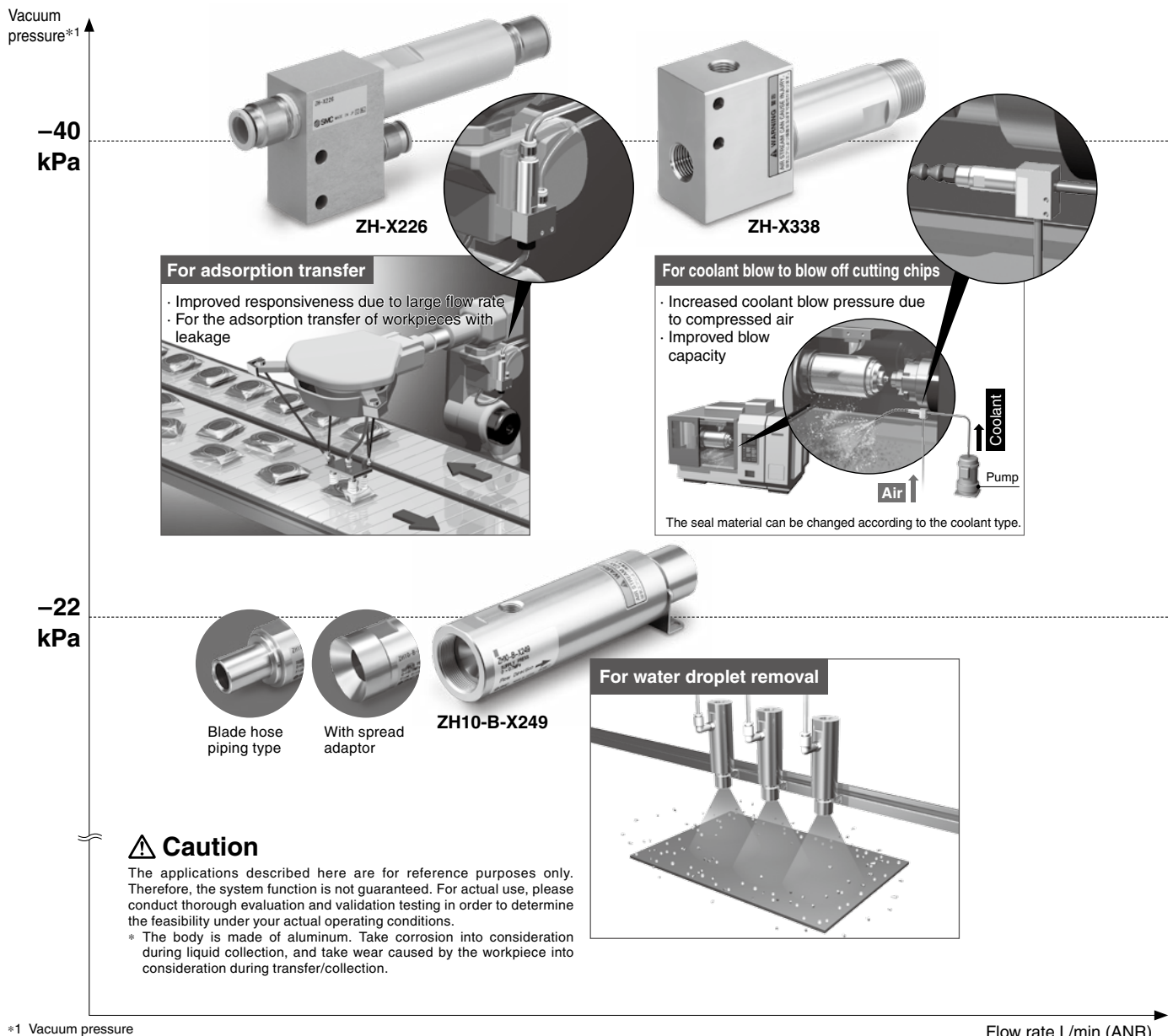

*1 Vacuum pressure at 0.5 MPa supply pressure

Related Product

Vacuum Flow

ZH-X226



Model/Specifications

| Model | ZH-X226 |
|---|--|
| Body material | Aluminum alloy |
| Seal material | NBR |
| Passage diameter | $\phi 8$ |
| C [dm ³ /(s·bar)] (Effective area [mm ²])*1 | 0.83 (4.13) |
| Fluid | Air |
| Supply pressure range | 0 to 0.7 MPa |
| Ambient and fluid temperatures [°C] | -5 to 80 (No freezing or condensation) |
| Weight [g] | 240 |

*1 The C value and the effective area are theoretical values.

Exhaust Characteristics

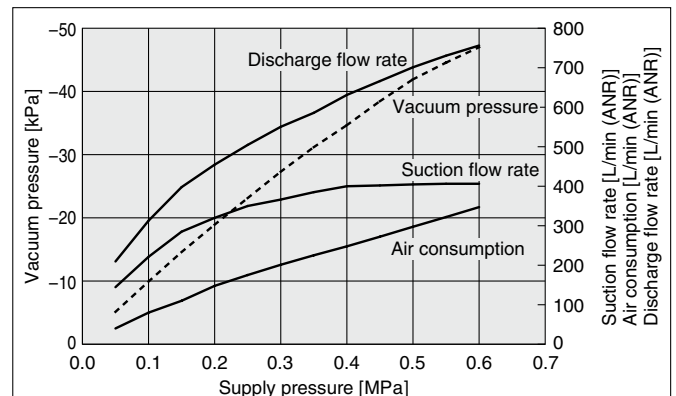

This data was acquired under SMC's measurement conditions. Therefore, the characteristics are not guaranteed. In addition, the data shows representative values and the performance may change depending on the piping conditions, etc. Be sure to conduct tests on the actual equipment to test for compatibility with the intended application.

Dimensions

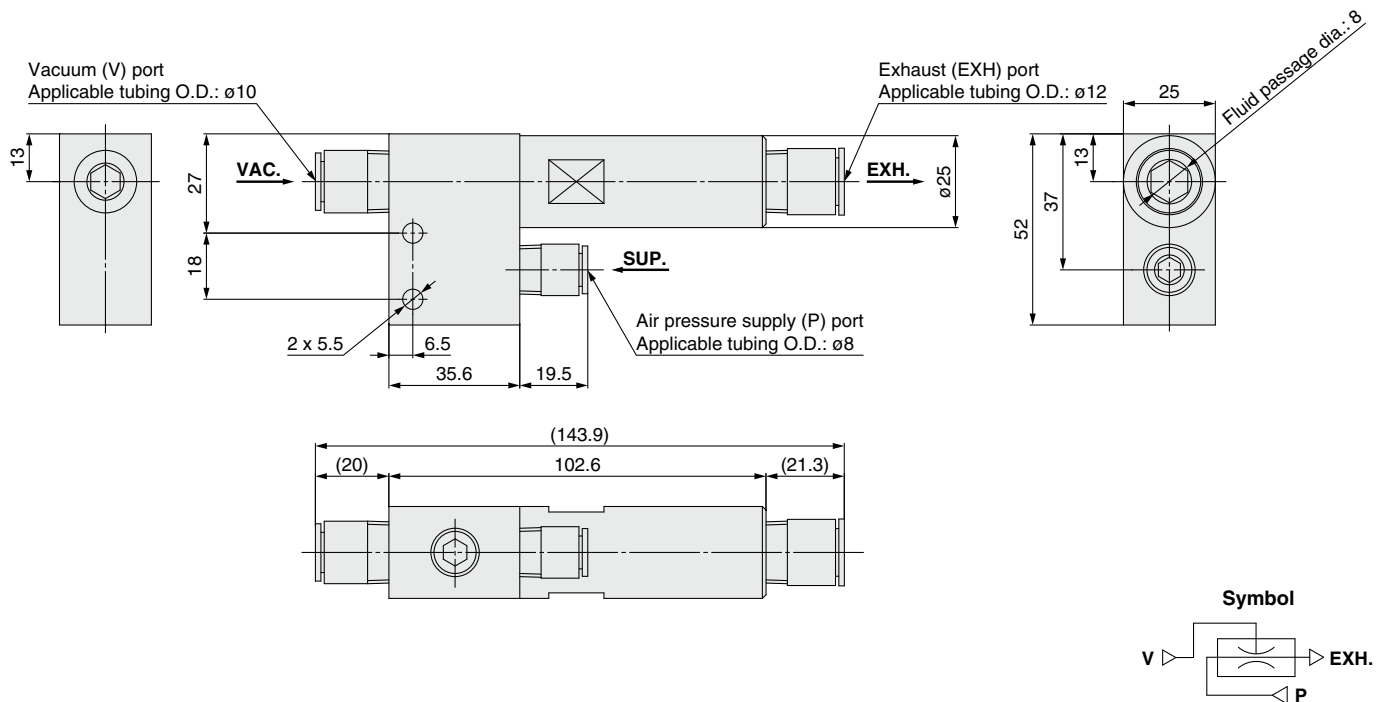

⚠ Specific Product Precautions

Be sure to read this before handling the products. For safety instructions and vacuum equipment precautions, refer to the **Web Catalog**: <https://www.smcworld.com>

Operating Precautions

⚠ Warning

1. Because suctioned matter is ejected together with the exhaust, do not direct an exhaust port at a person or other equipment.
2. Do not use in an atmosphere which contains corrosive gases, chemicals, organic solvents, sea water, water steam, or where there is direct contact with any of these.

Related Product

Vacuum Flow

ZH-X338

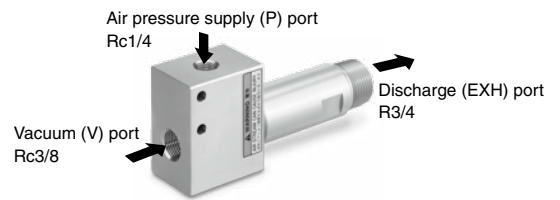

Model/Specifications

| Model | ZH-X338 |
|---|--|
| Body material | Aluminum alloy |
| Seal material | NBR |
| Passage diameter | ø12 |
| C [dm ³ /(s·bar)] (Effective area [mm ²])*1 | 1.58 (7.92) |
| Fluid | Air |
| Supply pressure range | 0 to 0.7 MPa |
| Ambient and fluid temperatures [°C] | -5 to 80 (No freezing or condensation) |
| Weight [g] | 328 |

*1 The C value and the effective area are theoretical values.

* Refer to page 17 for specific product precautions.

Exhaust Characteristics

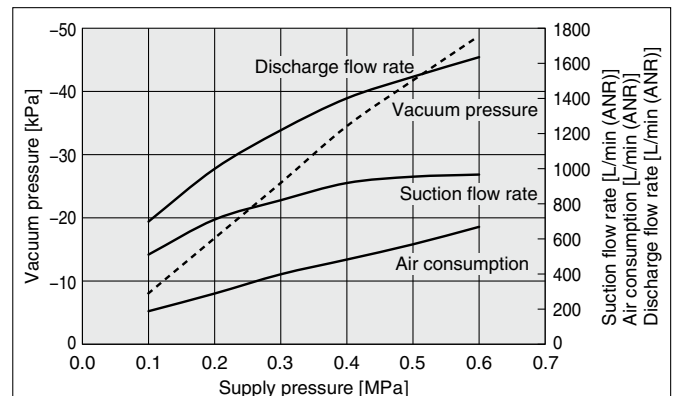

This data was acquired under SMC's measurement conditions. Therefore, the characteristics are not guaranteed. In addition, the data shows representative values and the performance may change depending on the piping conditions, etc. Be sure to conduct tests on the actual equipment to test for compatibility with the intended application.

Dimensions

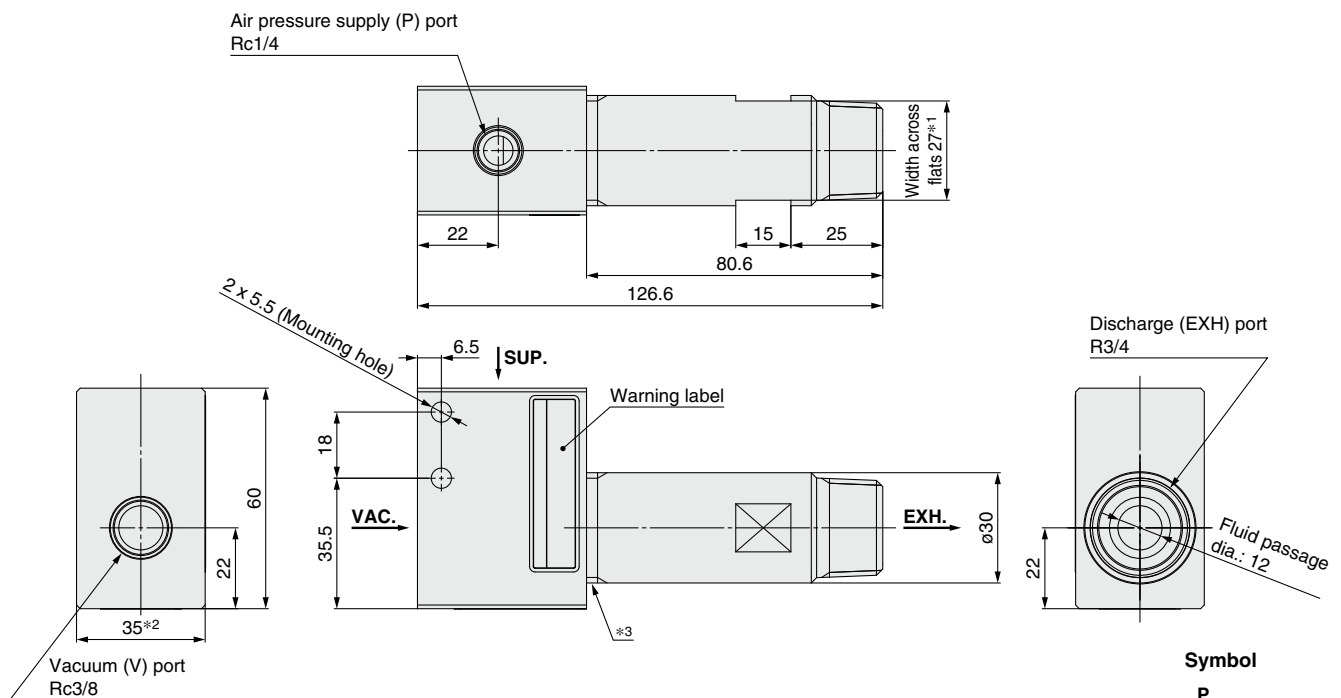

- *1 When connecting (or removing) piping, etc., to the exhaust (EXH) port, be sure to hold the width across flats.
- *2 When connecting (or removing) piping, etc., to the air pressure supply (P) port or the vacuum (V) port, be sure to hold the sides of the body.
- *3 If torque is applied to this thread part, the performance of the product may be affected.

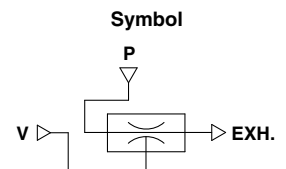

Related Product

Vacuum Flow

ZH10-B-X249

How to Order

ZH10 - B - X249

Suction port type

| | | | | | |
|-----|-------------------|---|------------------------|---|---------------------|
| Nil | Screw piping type | P | Blade hose piping type | W | With spread adaptor |
|-----|-------------------|---|------------------------|---|---------------------|

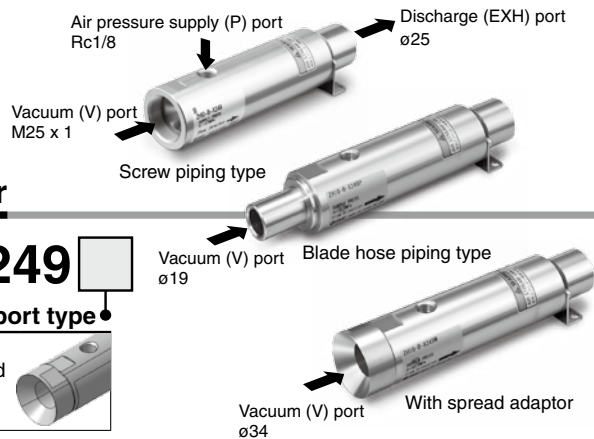

Specifications

| Model | ZH10-B-X249 | ZH10-B-X249P | ZH10-B-X249W |
|---|--|--------------|--------------|
| Body material | Aluminum alloy | | |
| Seal material | NBR | | |
| Passage diameter | ø11.5 | | |
| C [dm ³ /(s·bar)] (Effective area [mm ²])*1 | 0.94 (4.72) | | |
| Fluid | Air | | |
| Supply pressure range | 0 to 0.7 MPa | | |
| Ambient and fluid temperatures [°C] | -5 to 80 (No freezing or condensation) | | |
| Weight [g] | 250 | 267 | 278 |

*1 The C value and the effective area are theoretical values.

* Refer to page 17 for specific product precautions.

Exhaust Characteristics

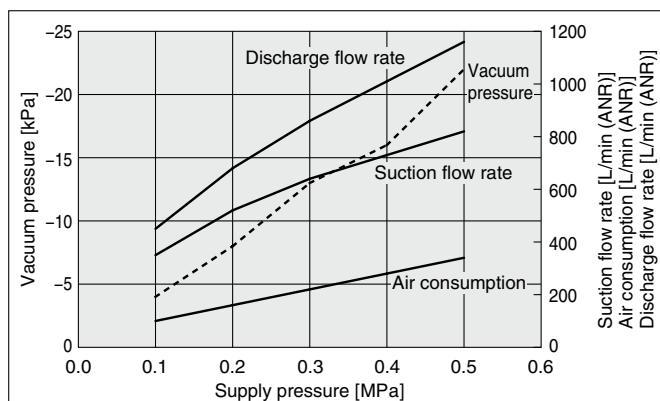

This data was acquired under SMC's measurement conditions. Therefore, the characteristics are not guaranteed. In addition, the data shows representative values and the performance may change depending on the piping conditions, etc. Be sure to conduct tests on the actual equipment to test for compatibility with the intended application.

Dimensions

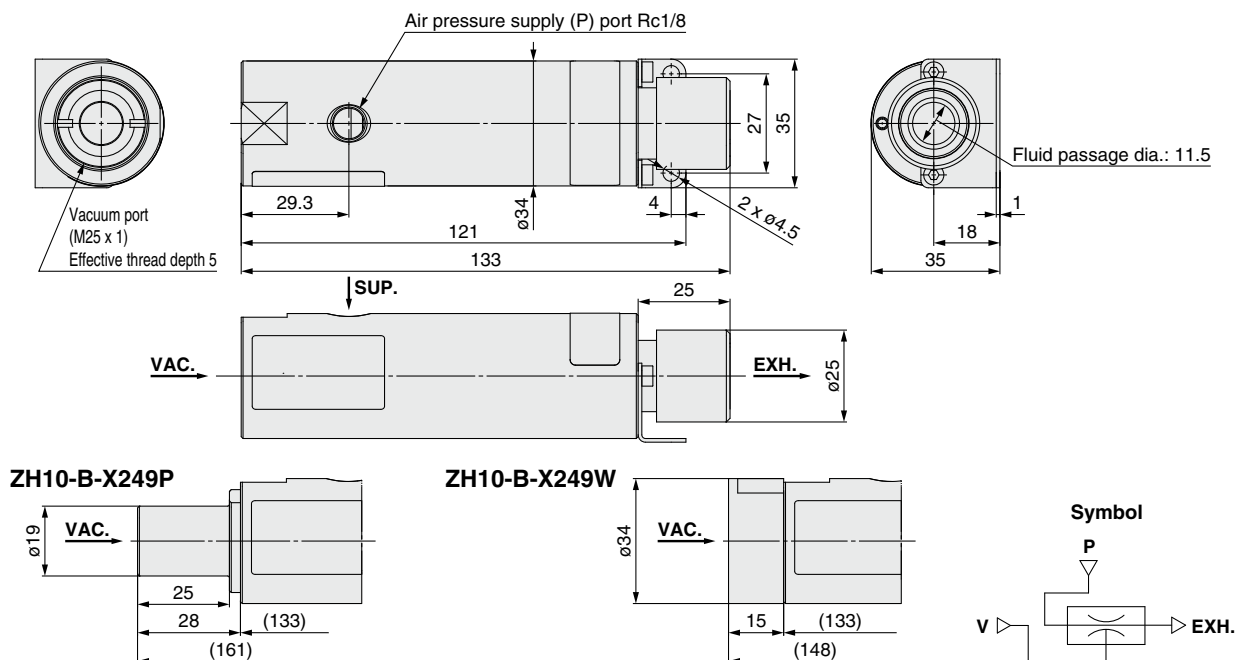

Equipment for Blowing

Blow Gun VMG



- A 20% reduction in power consumption can be achieved with the SMC "Blow gun" + "S coupler" + "Coil tube."
- Pressure loss: 1% or less (Nozzle diameter: $\phi 2.5$)
- Available nozzles:
Male thread nozzle, High efficiency nozzle with male thread, Low noise nozzle with male thread, Copper extension nozzle
- With flow rate adjustment function (-X54)



Available nozzles

KN series



Pulse Blow Valve AXTS040□-□□-X2



- The peak pressure of repeatedly colliding air permits efficient blowing.
- Air consumption: Reduced by 50% or more
- Pulse blow can be used by simply supplying air.

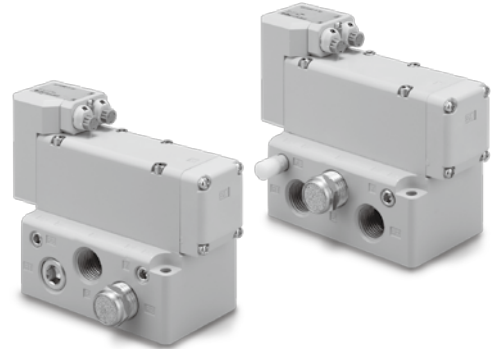

Air Saving Impact Blow Gun IBG



- Increased impact force due to higher peak pressure
- Drastic reduction in air consumption and labor time
- Application: It is capable of eliminating, in a short period of time, the dust, etc., that is difficult to remove with the existing blow gun.

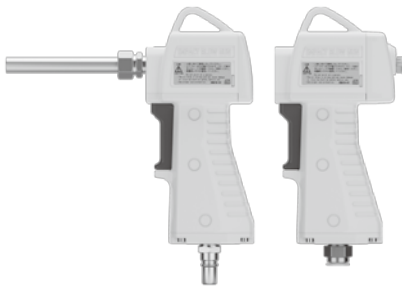

Available nozzles

Long nozzle



Long nozzle with a silencer



Impact Blow Valve IBV1□-X5/X7(-Q)



- Increased impact force due to higher peak pressure
- Drastic reduction in air consumption and labor time
- High peak pressure: 3 times or more (Compared with the existing model)
- Air consumption: 93% reduction
- Compact design allows for installation in narrow spaces.

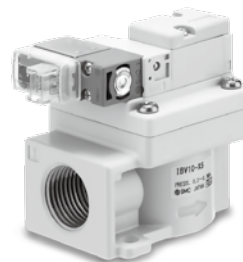

Available nozzles

Long nozzle



Long nozzle with a silencer



Pilot Operated 2-Port Solenoid Valve for Dry Air VQ20/30



- Applications: Air-blow, Blow-off of workpieces, etc.
- High-frequency operation is possible: High-speed response 7 ms or less (VQ20), 20 ms or less (VQ30)
- Easy piping with One-touch fittings
- The dust-tight, water-jet-proof enclosure (IP65) is compatible with the DIN terminal type.
- Manifold type no.: VV2Q22, VV2Q32

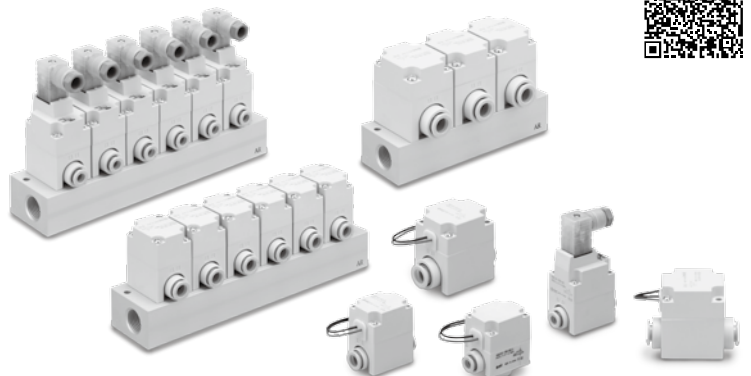

Equipment for Blowing

For Clean Blow

Clean Air Module LLB



- Modularized clean equipment (Reduced piping labor, Space saving)
Makes clean air easily available
- Nominal filtration rating: 0.01 μm (Filtration efficiency: 99.99%)
- Wetted parts: Grease-free, Silicone-free
- Assembled in a clean room, Shipped and packed in double packaging
- 24 combinations are available.



- Can perform the clean air blow of small workpieces with a flow rate of up to 100 L/min

Made to order

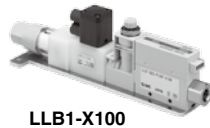

N₂ blow for the removal of lens dust

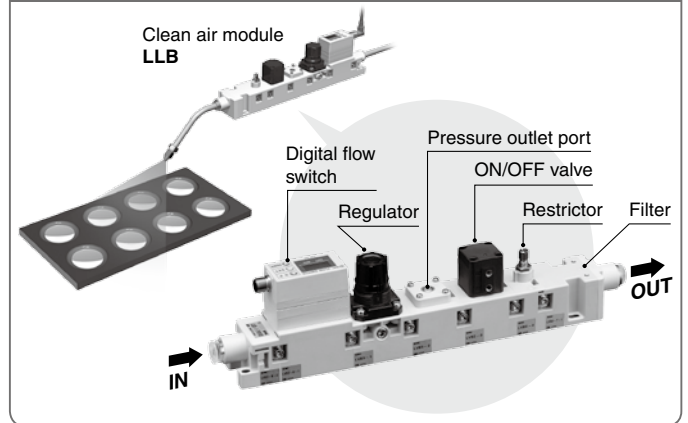

Bacteria Removal Filter/ Hollow Fiber Element SFDA



- Bacteria capture performance: LRV ≥ 9
Uses FDA/Food Sanitation Law compliant materials*1
*1 Parts in contact with fluid: Resin/Rubber
- Grease-free
- Contributes to the hygiene control of HACCP, etc., and FSSC22000 certification acquisition!
- Nominal filtration rating: 0.01 μm (Filtering efficiency: 99.99%)
- Initial pressure drop: 0.03 MPa (Inlet pressure 0.7 MPa, at max. flow rate)
- Flow rate: 500 L/min (ANR)



Clean One-touch Fittings for Blowing KP



- One-touch fittings for clean room blowing systems
- Completely oil-free (Fluoro-coated rubber portions)
- Wetted parts are non-metallic.
- Parts washed and assembled in a clean room, Packed in double packaging
- Can be used in a vacuum (-100 kPa)



Technical Data

Comparison Table (Thrust, Noise, Flow consumption, Air flow)

Pressure right before the nozzle: 0.2 MPa

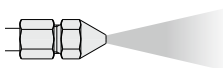
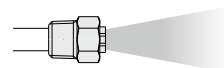
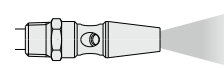
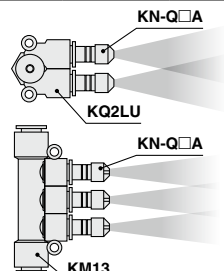
| | | Mono-porous nozzle (KN series) | | | Low noise nozzle (KNS series) | | | High efficiency nozzle (KNH series) | | | Twin/Triple nozzle (KQ2LU, KM13 + KN-Q□A series) | | |
|------------|-----------------|---|------------------------------|-------------------------------------|---|------------------------------|-----------------|--|---|-------------------------------------|---|------------------------------|--|
| | |  | | |  | | |  | | |  | | |
| Thrust [N] | Nozzle diameter | Noise dB(A) | Flow consumption L/min (ANR) | Nozzle diameter x Number of nozzles | Noise dB(A) | Flow consumption L/min (ANR) | Nozzle diameter | Noise dB(A) | Air flow [Flow consumption L/min (ANR)] | Nozzle diameter x Number of nozzles | Noise dB(A) | Flow consumption L/min (ANR) | |
| 0.2 | ø1 | 65 | 27 | | | | | | | | | | |
| 0.3 | | | | | | | ø1 | 76.2 | 103 [25] | | | | |
| 0.4 | | | | | | | | | | ø1 x 2 | 66.5 | 46 | |
| 0.5 | ø1.5 | 74 | 58 | ø0.75 x 4 | 64 | 52 | | | | | | | |
| 0.6 | | | | | | | ø1.5 | 81 | 169 [54] | | | | |
| 0.7 | | | | | | | | | | ø1 x 3 | 70 | 76 | |
| 0.8 | | | | ø1.0 x 4 | 70 | 96 | | | | | | | |
| 0.9 | | | | | | | | | | ø1 x 4 | 69 | 93 | |
| 1.0 | ø2 | 81.8 | 105 | | | | ø2 | 88.6 | 220 [111] | ø1.5 x 2 | 77 | 112 | |
| 1.3 | | | | ø0.9 x 8 | 71 | 133 | | | | | | | |
| 1.5 | ø2.5 | 87.2 | 172 | | | | | | | ø1.5 x 3 | 75.4 | 163 | |
| 1.6 | | | | | | | | | | | | | |
| 1.9 | | | | | | | | | | ø2 x 2 | 83.4 | 205 | |
| 2.0 | | | | ø1.1 x 8 | 77 | 237 | | | | | | | |
| 2.2 | | | | | | | | | | | | | |
| 2.3 | ø3 | 91.7 | 220 | | | | | | | | | | |
| 2.7 | | | | | | | | | | ø2.5 x 2 | 87.1 | 298 | |
| 3.0 | | | | | | | | | | | | | |
| 3.1 | ø3.5 | 95.6 | 337 | | | | | | | | | | |
| 4.0 | ø4 | 98.7 | 430 | | | | | | | ø3 x 2 | 90.1 | 443 | |
| 5.6 | | | | | | | | | | | | | |
| 9.0 | ø6 | 104 | 1030 | | | | | | | | | | |
| 16.3 | ø8 | 109 | 1605 | | | | | | | | | | |

Pressure right before the nozzle: 0.4 MPa

| | | | | | | | | | | | | |
|------|------|------|------|-----------|------|-----|------|----|-----------|----------|------|-----|
| ∴ | | | | | | | | | | | | |
| 0.5 | ø1 | 74.6 | 43 | | | | ø1 | 82 | 153 [41] | | | |
| 0.8 | | | | | | | | | | ø1 x 2 | 75.3 | 78 |
| 0.9 | | | | ø0.75 x 4 | 72.6 | 87 | | | | | | |
| 1.0 | ø1.5 | 83 | 97 | | | | | | | | | |
| 1.1 | | | | | | | ø1.5 | 90 | 231 [82] | | | |
| 1.3 | | | | | | | | | | ø1 x 3 | 78.5 | 125 |
| 1.7 | | | | ø1.0 x 4 | 78.6 | 152 | | | | ø1 x 4 | 77.3 | 153 |
| 1.8 | | | | | | | | | | | | |
| 1.9 | ø2 | 91.4 | 176 | | | | ø2 | 91 | 308 [180] | | | |
| 2.0 | | | | | | | | | | ø1.5 x 2 | 86 | 189 |
| 2.6 | | | | ø0.9 x 8 | 81.2 | 208 | | | | | | |
| 2.7 | | | | | | | | | | | | |
| 2.9 | ø2.5 | 96.7 | 289 | | | | | | | ø1.5 x 3 | 83.2 | 272 |
| 3.5 | | | | | | | | | | | | |
| 3.6 | | | | | | | | | | ø2 x 2 | 93.5 | 338 |
| 4.0 | | | | ø1.1 x 8 | 87.6 | 391 | | | | | | |
| 4.3 | | | | | | | | | | | | |
| 4.4 | ø3 | 101 | 363 | | | | | | | | | |
| 5.2 | | | | | | | | | | ø2.5 x 2 | 96.1 | 497 |
| 5.9 | ø3.5 | 106 | 542 | | | | | | | | | |
| 6.4 | | | | | | | | | | | | |
| 7.7 | ø4 | 106 | 722 | | | | | | | ø3 x 2 | 100 | 724 |
| 11.6 | | | | | | | | | | | | |
| 17.6 | ø6 | 110 | 1730 | | | | | | | | | |
| 30.9 | ø8 | 112 | 3030 | | | | | | | | | |

Comparison Table (Thrust, Noise, Flow consumption, Air flow)

Pressure right before the nozzle: 0.6 MPa

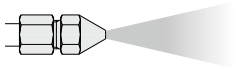
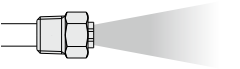
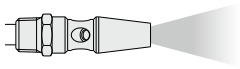
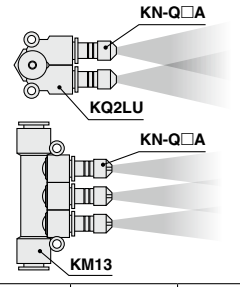
| | Mono-porous nozzle (KN series) | | | Low noise nozzle (KNS series) | | | High efficiency nozzle (KNH series) | | | Twin/Triple nozzle (KQ2LU, KM13 + KN-Q□A series) | | |
|------------|---|-------------|------------------------------|---|-------------|------------------------------|--|-------------|---|---|-------------|------------------------------|
| |  | | |  | | |  | | |  | | |
| Thrust [N] | Nozzle diameter | Noise dB(A) | Flow consumption L/min (ANR) | Nozzle diameter x Number of nozzles | Noise dB(A) | Flow consumption L/min (ANR) | Nozzle diameter | Noise dB(A) | Air flow [Flow consumption L/min (ANR)] | Nozzle diameter x Number of nozzles | Noise dB(A) | Flow consumption L/min (ANR) |
| ∴ | | | | | | | | | | | | |
| 0.7 | ø1 | 79 | 60 | | | | ø1 | 84 | 202 [57] | | | |
| 1.2 | | | | | | | | | | ø1 x 2 | 80 | 108 |
| 1.4 | | | | ø0.75 x 4 | 78 | 121 | | | | | | |
| 1.5 | ø1.5 | 86 | 135 | | | | | | | | | |
| 1.6 | | | | | | | ø1.5 | 92 | 326 [125] | | | |
| 1.9 | | | | | | | | | | ø1 x 3 | 83 | 177 |
| 2.3 | | | | | | | | | | | | |
| 2.5 | | | | ø1.0 x 4 | 84 | 224 | | | | ø1 x 4 | 83 | 220 |
| 2.8 | | | | | | | ø2 | 97 | 400 [253] | | | |
| 2.9 | ø2 | 95 | 243 | | | | | | | | | |
| 3.0 | | | | | | | | | | ø1.5 x 2 | 91 | 265 |
| 3.9 | | | | ø0.9 x 8 | 86 | 330 | | | | | | |
| 4.1 | | | | | | | | | | | | |
| 4.2 | | | | | | | | | | ø1.5 x 3 | 87 | 381 |
| 4.4 | ø2.5 | 101 | 400 | | | | | | | | | |
| 5.3 | | | | | | | | | | ø2 x 2 | 98 | 475 |
| 5.4 | | | | | | | | | | | | |
| 5.5 | | | | | | | | | | | | |
| 5.9 | | | | ø1.1 x 8 | 93.1 | 554 | | | | | | |
| 6.5 | ø3 | 105 | 552 | | | | | | | | | |
| 7.6 | | | | | | | | | | ø2.5 x 2 | 100 | 694 |
| 8.7 | ø3.5 | 109 | 771 | | | | | | | | | |
| 9.8 | | | | | | | | | | | | |
| 11.1 | | | | | | | | | | ø3 x 2 | 103 | 1025 |
| 11.5 | ø4 | 109 | 995 | | | | | | | | | |
| 17.5 | | | | | | | | | | | | |
| 26.1 | ø6 | 112 | 2430 | | | | | | | | | |
| 46.3 | ø8 | 115 | 4320 | | | | | | | | | |

Energy Saving Program

- Allows you to perform various calculations necessary to improve the pneumatic energy saving
- Twenty different functions including air blow characteristics, pneumatics piping network, and combination of conductance
- Supports designing, current status analysis, and simulations for improvement



Model Selection

Recommended Circuit Configuration for Blowing

Optimization of an air blow system

For the optimization of an air blow system, it is important to make the ratio of the conductance of the components upstream and the conductance of the nozzle tip to the recommended value. By achieving this ratio, the system will allow high-pressure blow and flow rate reduction with a low pressure loss.

The conductance ratio recommended by SMC is 3:1 considering the energy-saving efficiency and installation cost.

* Conductance: Index of air flow ability

Optimization process

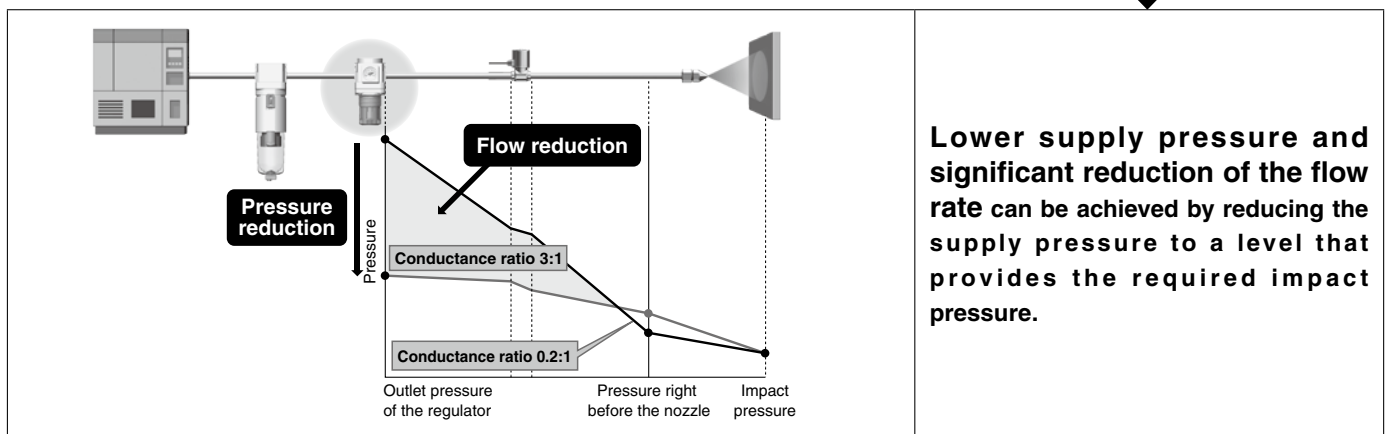
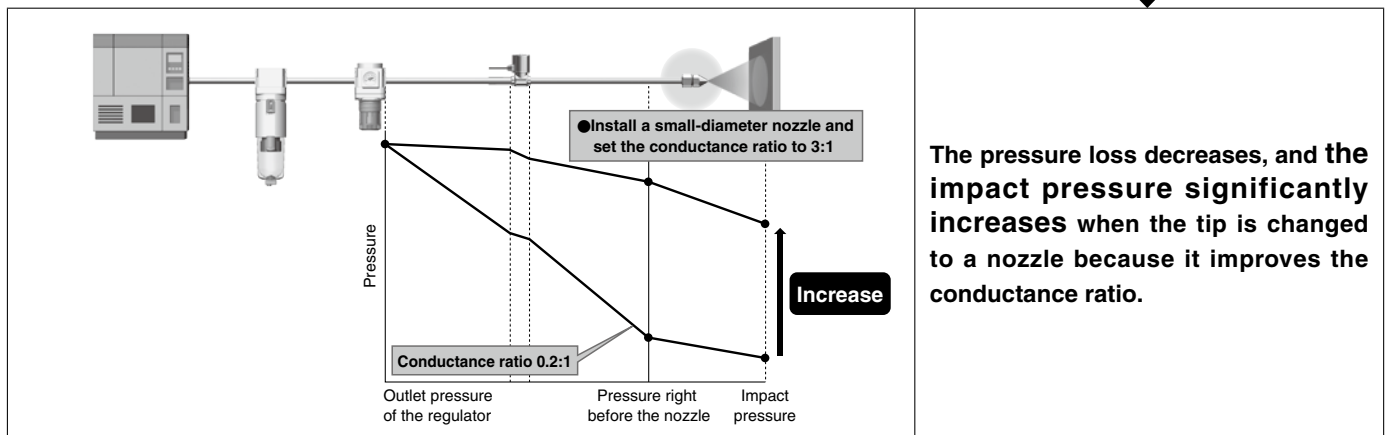
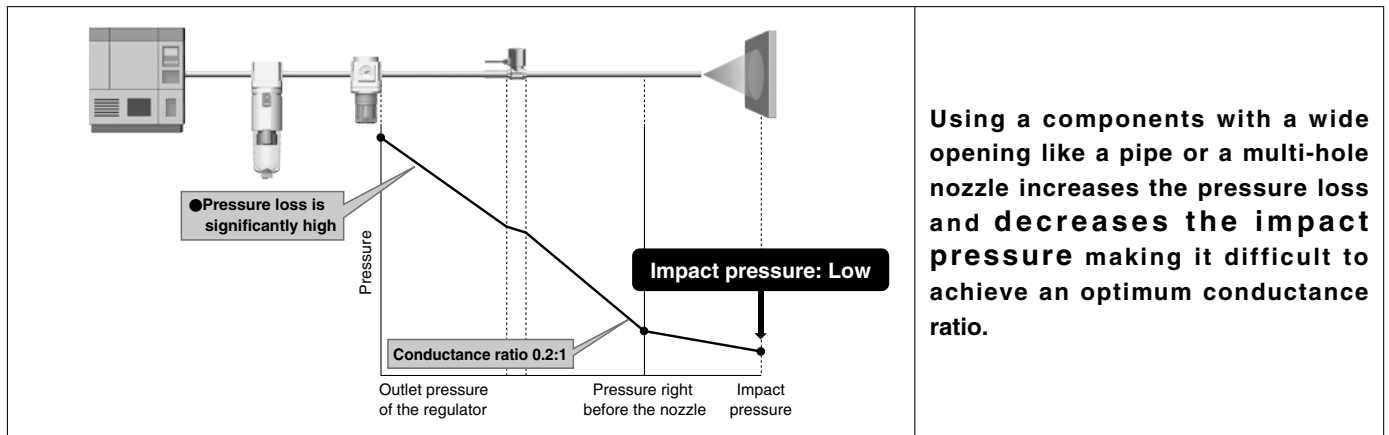

Optimization process complete

Piping lengths for conductance optimization

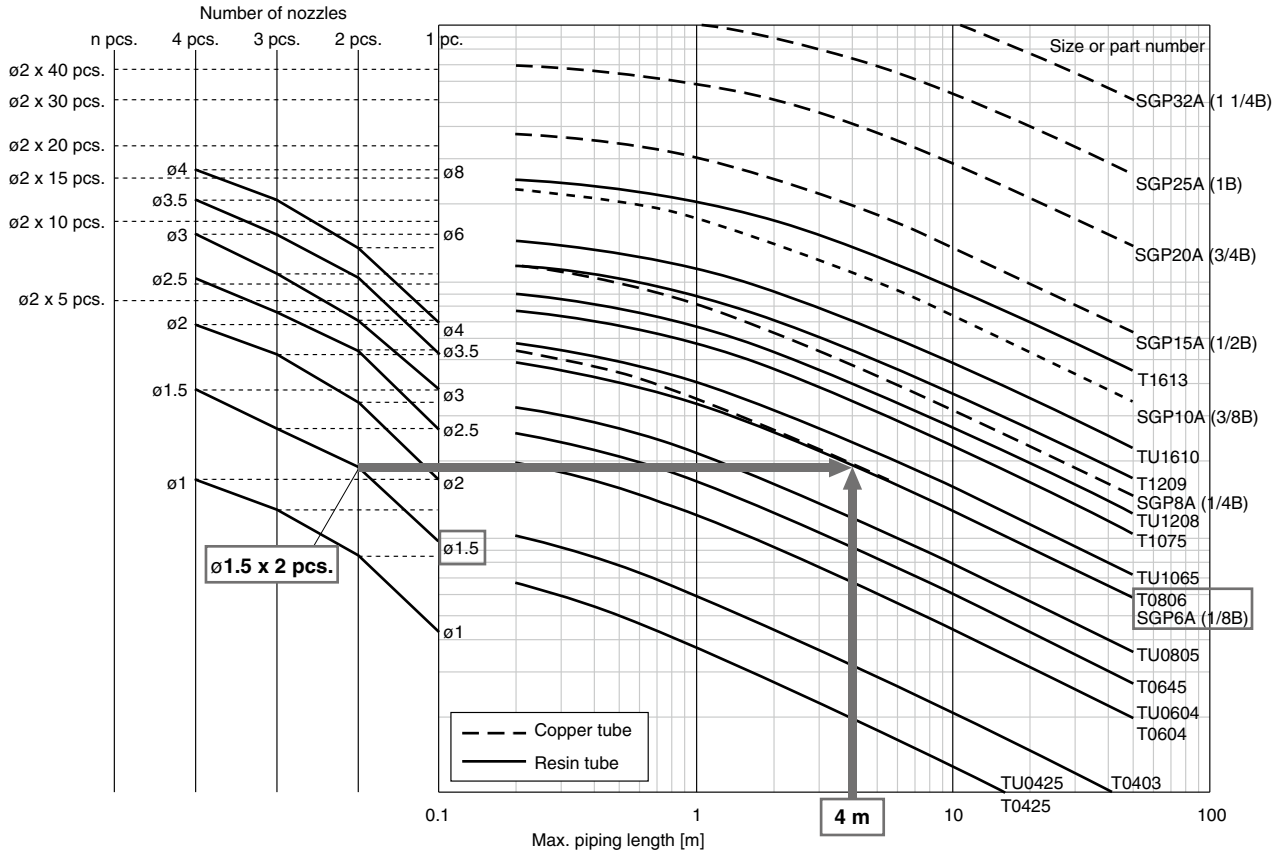

Optimization for 2-port valve with regulator model

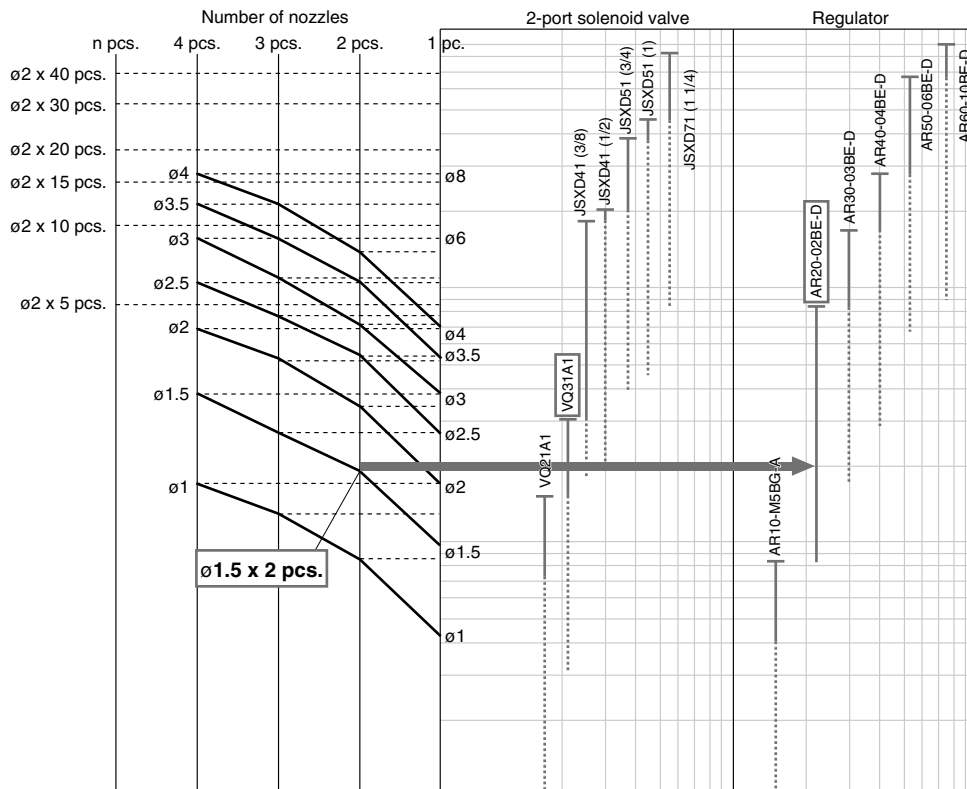

Glossary of Terms

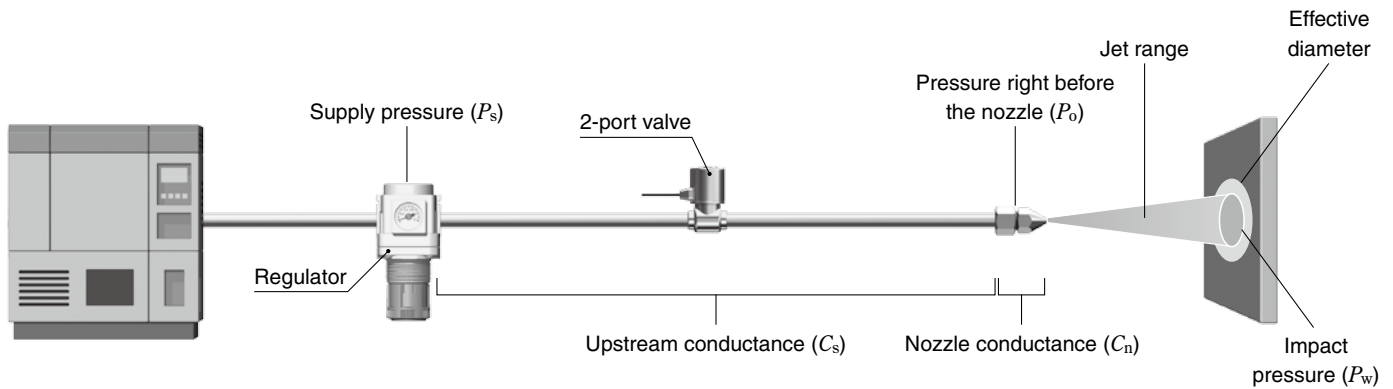

| Term | Description |
|--|--|
| Pressure right before the nozzle (P_o) | The pressure right before the air is blown out from the nozzle. Pressure in the nozzle |
| Workpiece impact pressure (P_w) | Pressure when the air blown out of the nozzle collides with the workpiece |
| Conductance ratio | The ratio of conductance of the nozzle (C_n) and the upstream components (C_s) Setting the upstream side to 2 to 3 times the nozzle is recommended. |
| Pressure loss | Pressure loss of the supply pressure (difference between P_s and P_o) caused by the piping route. Lower pressure loss results in the better efficiency. |
| Jet range | Effective energy range inside the air that widens conically at the angle of 14 degrees from the nozzle opening |
| Effective diameter | The range in which the blowing effect is achieved in an area wider than the jet area |
| Potential core region | The range is equal to the nozzle diameter x 5. In this range, it interferes with the expansion thrust of the compressed air and the energy of the air blow cannot be used effectively. |
| Developing region | The range after the potential core region where the air blow thrust can be used effectively |

* Conductance: Index of air flow ability

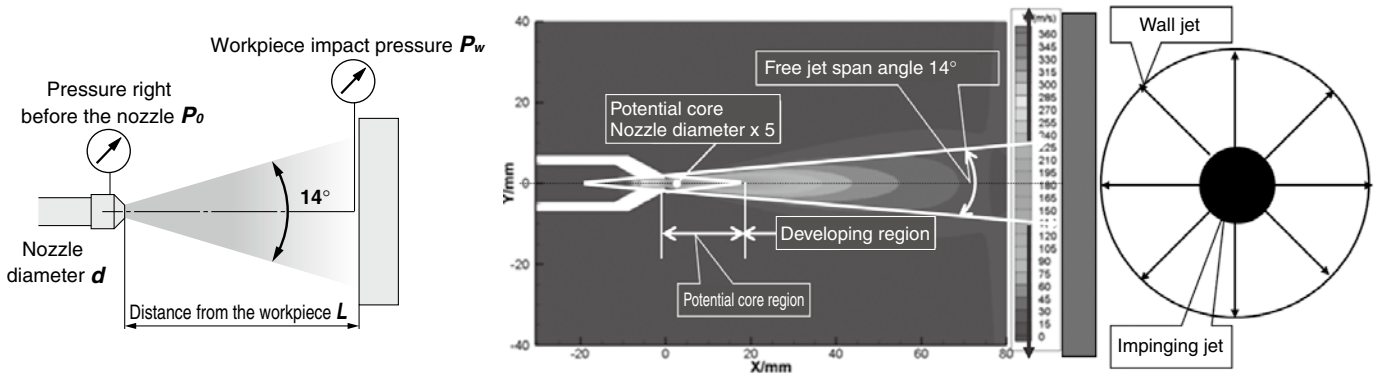

Air Blow System and Conductance

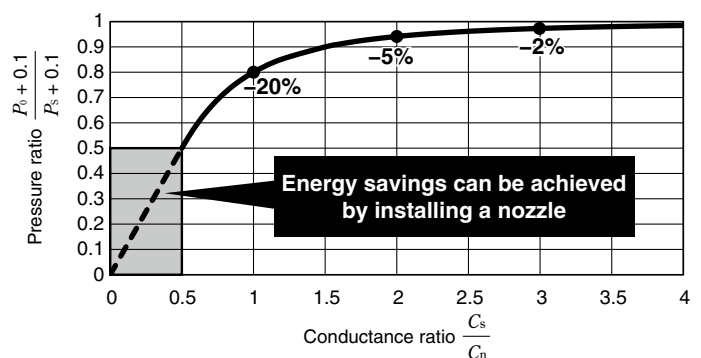
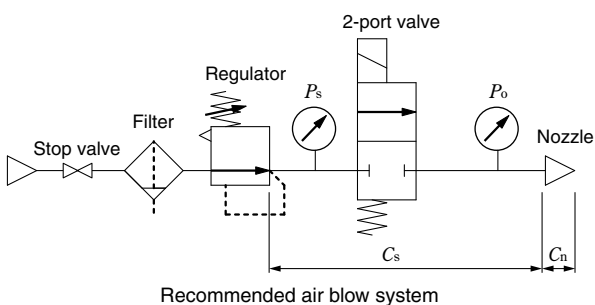



P_s : Supply pressure
 P_o : Pressure right before the nozzle
 C_s : Upstream conductance
 C_n : Nozzle conductance

} Pressure ratio $\frac{P_o + 0.1}{P_s + 0.1}$
 } Conductance ratio $\frac{C_s}{C_n}$

Safety Instructions

These safety instructions are intended to prevent hazardous situations and/or equipment damage. These instructions indicate the level of potential hazard with the labels of “**Caution**,” “**Warning**” or “**Danger**.” They are all important notes for safety and must be followed in addition to International Standards (ISO/IEC)*1), and other safety regulations.

 **Caution:** **Caution** indicates a hazard with a low level of risk which, if not avoided, could result in minor or moderate injury.

 **Warning:** **Warning** indicates a hazard with a medium level of risk which, if not avoided, could result in death or serious injury.

 **Danger :** **Danger** indicates a hazard with a high level of risk which, if not avoided, will result in death or serious injury.

*1) ISO 4414: Pneumatic fluid power – General rules relating to systems.
ISO 4413: Hydraulic fluid power – General rules relating to systems.
IEC 60204-1: Safety of machinery – Electrical equipment of machines.
(Part 1: General requirements)
ISO 10218-1: Manipulating industrial robots – Safety.
etc.

Warning

1. The compatibility of the product is the responsibility of the person who designs the equipment or decides its specifications.

Since the product specified here is used under various operating conditions, its compatibility with specific equipment must be decided by the person who designs the equipment or decides its specifications based on necessary analysis and test results. The expected performance and safety assurance of the equipment will be the responsibility of the person who has determined its compatibility with the product. This person should also continuously review all specifications of the product referring to its latest catalog information, with a view to giving due consideration to any possibility of equipment failure when configuring the equipment.

2. Only personnel with appropriate training should operate machinery and equipment.

The product specified here may become unsafe if handled incorrectly. The assembly, operation and maintenance of machines or equipment including our products must be performed by an operator who is appropriately trained and experienced.

3. Do not service or attempt to remove product and machinery/equipment until safety is confirmed.

1. The inspection and maintenance of machinery/equipment should only be performed after measures to prevent falling or runaway of the driven objects have been confirmed.
2. When the product is to be removed, confirm that the safety measures as mentioned above are implemented and the power from any appropriate source is cut, and read and understand the specific product precautions of all relevant products carefully.
3. Before machinery/equipment is restarted, take measures to prevent unexpected operation and malfunction.

4. Contact SMC beforehand and take special consideration of safety measures if the product is to be used in any of the following conditions.

1. Conditions and environments outside of the given specifications, or use outdoors or in a place exposed to direct sunlight.
2. Installation on equipment in conjunction with atomic energy, railways, air navigation, space, shipping, vehicles, military, medical treatment, combustion and recreation, or equipment in contact with food and beverages, emergency stop circuits, clutch and brake circuits in press applications, safety equipment or other applications unsuitable for the standard specifications described in the product catalog.
3. An application which could have negative effects on people, property, or animals requiring special safety analysis.
4. Use in an interlock circuit, which requires the provision of double interlock for possible failure by using a mechanical protective function, and periodical checks to confirm proper operation.

Caution

1. The product is provided for use in manufacturing industries.

The product herein described is basically provided for peaceful use in manufacturing industries.
If considering using the product in other industries, consult SMC beforehand and exchange specifications or a contract if necessary.
If anything is unclear, contact your nearest sales branch.

Limited warranty and Disclaimer/ Compliance Requirements

The product used is subject to the following “Limited warranty and Disclaimer” and “Compliance Requirements”.

Read and accept them before using the product.

Limited warranty and Disclaimer

1. The warranty period of the product is 1 year in service or 1.5 years after the product is delivered, whichever is first.*2)
Also, the product may have specified durability, running distance or replacement parts. Please consult your nearest sales branch.
2. For any failure or damage reported within the warranty period which is clearly our responsibility, a replacement product or necessary parts will be provided.
This limited warranty applies only to our product independently, and not to any other damage incurred due to the failure of the product.
3. Prior to using SMC products, please read and understand the warranty terms and disclaimers noted in the specified catalog for the particular products.

*2) Vacuum pads are excluded from this 1 year warranty.

A vacuum pad is a consumable part, so it is warranted for a year after it is delivered.
Also, even within the warranty period, the wear of a product due to the use of the vacuum pad or failure due to the deterioration of rubber material are not covered by the limited warranty.

Compliance Requirements

1. The use of SMC products with production equipment for the manufacture of weapons of mass destruction (WMD) or any other weapon is strictly prohibited.
2. The exports of SMC products or technology from one country to another are governed by the relevant security laws and regulations of the countries involved in the transaction. Prior to the shipment of a SMC product to another country, assure that all local rules governing that export are known and followed.

Caution

SMC products are not intended for use as instruments for legal metrology.

Measurement instruments that SMC manufactures or sells have not been qualified by type approval tests relevant to the metrology (measurement) laws of each country. Therefore, SMC products cannot be used for business or certification ordained by the metrology (measurement) laws of each country.

 **Safety Instructions** Be sure to read the “Handling Precautions for SMC Products” (M-E03-3) and “Operation Manual” before use.

SMC Corporation

Akihabara UDX 15F,
4-14-1, Sotokanda, Chiyoda-ku, Tokyo 101-0021, JAPAN
Phone: 03-5207-8249 Fax: 03-5298-5362
<https://www.smcworld.com>
© 2022 SMC Corporation All Rights Reserved

Specifications are subject to change without prior notice
and any obligation on the part of the manufacturer.

D-G