

# High Purity Chemical Liquid Valve Non-Metallic Exterior

## LVQ Series

Clean Wet Series

### Screwless construction

Non-metallic construction without using metal screws to fasten the body of the actuator.

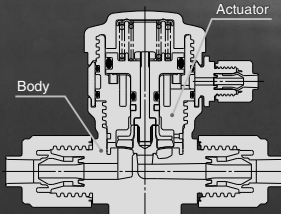

Body: **New PFA**  
 Diaphragm: **PTFE**  
 Actuator: **PVDF**

### Additional Variations for the LVQ Series!

- Insert bushing, LQ1 integrated fitting type  
Hyper fitting  
**LVQ-V Series**

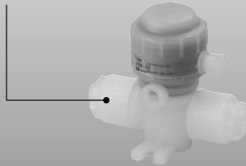

- Flare, LQ3 integrated fitting type  
Hyper fitting  
**LVQ-Z Series**

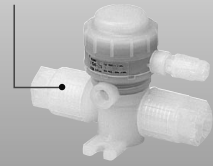

- Manually operated  
**LVQH Series**

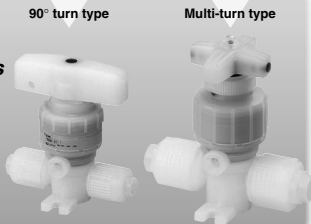

- Tube extension type  
**LVQ-T Series**



- High purity chemical liquid valves, High back pressure (0.5 MPa) tolerant Added the **LVQ□□H** series.
- Additional options  
High temperature (Max. 170°C), Buffer material FFKM, Ammonium hydroxide compatible, High flow type

LVC
LVA
LVH
LVD
<b>LVQ</b>
LVP
LVW
LQ1
LQ3
LVN
LQHB
TL
TIL
TLM
TILM
TD
TID
TH
TIH

● **Insert bushing/Flare, integrated fitting types are available.**

**Insert bushing, Integrated fitting type** *LVQ-V/LVQ-S Series*

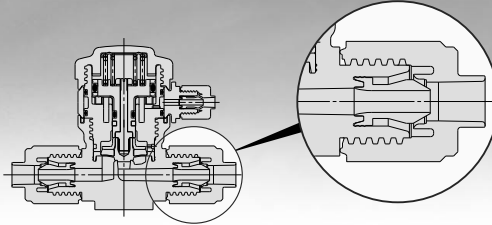

Hyper fitting

**New**

**LQ1 Series**  
(LVQ-V Series)

**LQ2 Series**  
(LVQ-S Series)

- Insert bushing type
- Quadruple seal construction

**Flare, Integrated fitting type** *LVQ-Z Series*

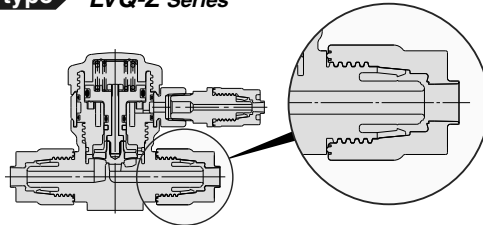

Hyper fitting  
Flare type

**LQ3 Series**

- Grip seal construction with Flare type
- Triple seal construction

● **Added manual type.**  
**Two types of handle operation methods can be selected.**

**90° turn type**



- Enables quick valve open/close switching operation.

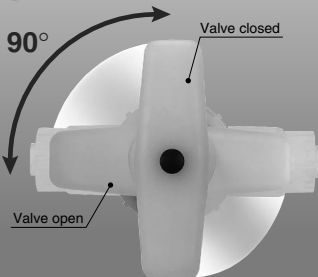

**Multi-turn type**



- The handle will spin loosely at the fully-open and fully-closed positions of the valve. This prevents overtightening.
- An indicator enables easy visual check of the open/closed state of the valve.
- The valve opening position can be freely set using a lock nut.

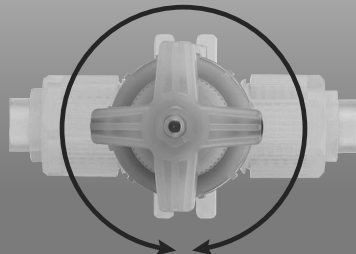

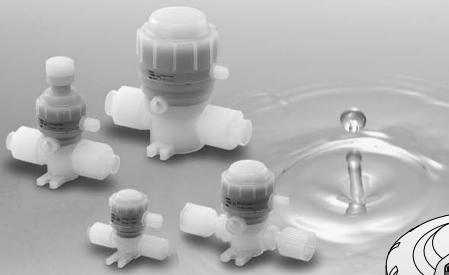

### Diaphragm (PTFE)

Special diaphragm construction ensures gentle opening and closing that prevents the formation of micro-bubbles.

### Minimal residual liquid

Residual liquid is minimized by the tapered shape and integrated fitting construction, allowing liquid to flow smoothly, achieving improved flow-through characteristics.

### Body (New PFA)

Compatible with chemicals such as acids, bases and super pure water.

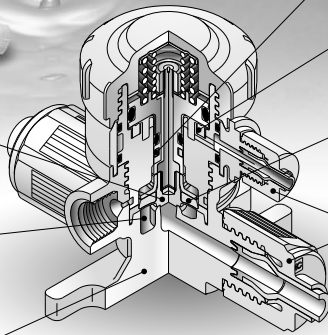

### Guide ring

Eliminates lateral motion of the poppet which reduces internal leakage.

### Piston damper

Absorbs piston momentum to minimize impact-induced particle generation.

### Buffer

Protects diaphragm from deformation and damage due to back pressure.

### Integrated fitting construction

Offers quadruple seal construction. Nut lock mechanism—no additional tightening required. High flexural strength. Different tubing sizes can be selected.

### Integrated fitting construction

Hyper fitting/LQ1, LQ2, LQ3 series is used.



### Integrated fitting construction

Hyper fitting/LQ1, LQ3 series is used. Can select female thread.

### Piping from 8 directions are possible.

Pilot port

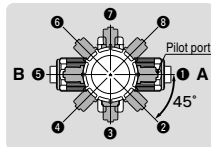

\* Specify the piping direction by part number when ordering the product. Do not change the pilot port direction. (Refer to Precautions on page 846.)

### Space saving type

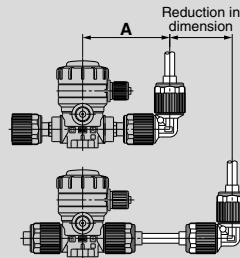

(mm)

Model	A	Reduction in dimension
LVQ20	56.5	40.5 or more
LVQ30	70	49.5 or more
LVQ40	80	61.5 or more
LVQ50	104.5	64.5 or more
LVQ60	114.5	73.5 or more

### Piping example

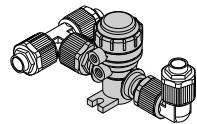

## Options

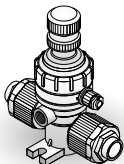

With flow rate adjustment

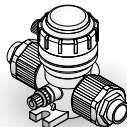

With by-pass

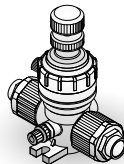

With flow rate adjustment & by-pass

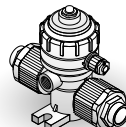

With indicator

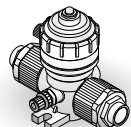

With indicator & by-pass

- LVC
- LVA
- LVH
- LVQ
- LVP
- LVW
- LQ1
- LQ3
- LVN
- LQHB
- TL
- TIL
- TLM
- TILM
- TD
- TID
- TH
- TIH

# Variations

## Insert Bushing, Integrated Fitting Type *LVQ/LVQH Series*



Orifice diameter	Flow rate characteristics Kv (Cv)	Series	Applicable tubing O.D.																			
			Metric size						Inch size													
			3	4	6	8	10	12	19	25	1/8	3/16	1/4	3/8	1/2	3/4	1					
ø4	0.3 (0.35)	LVQ(H)20	●	●	○								●	●	○							
ø8	1.1 (1.3)	LVQ(H)30			●	●		○							●	○						
ø10	1.6 (1.9)	LVQ(H)40						●	○							●	○					
ø16	4.2 (5)	LVQ(H)50								●	○						●	○				
ø22	6.8 (8)	LVQ(H)60										●	○					●	○			

● With reducer ○ Basic size

## Insert Bushing, Integrated Fitting Type Space Saving/Space Saving Connection *LVQS/LVQHS Series*



Orifice diameter	Flow rate characteristics Kv (Cv)	Series	Fitting size					
			2	3	4	5	6	
ø4	0.3 (0.35)	LVQ(H)S20	●					
ø8	1.1 (1.3)	LVQ(H)S30		●				
ø10	1.6 (1.9)	LVQ(H)S40			●			
ø16	4.2 (5)	LVQ(H)S50				●		
ø22	6.8 (8)	LVQ(H)S60					●	

## Flare, Integrated Fitting Type *LVQ-Z/LVQH-Z Series*



Orifice diameter	Flow rate characteristics Kv (Cv)	Series	Applicable tubing O.D.																			
			Metric size						Inch size													
			3	4	6	8	10	12	19	25	1/8	3/16	1/4	3/8	1/2	3/4	1					
ø4	0.3 (0.35)	LVQ20(H)-Z	●	●	●																	
ø8	1.1 (1.3)	LVQ30(H)-Z						●														
ø10	1.6 (1.9)	LVQ40(H)-Z							●													
ø16	4.2 (5)	LVQ50(H)-Z								●												
ø22	6.8 (8)	LVQ60(H)-Z									●											

## Flare, Integrated Fitting Type Space Saving/Space Saving Connection *LVQS-Z/LVQHS-Z Series*



Orifice diameter	Flow rate characteristics Kv (Cv)	Series	Fitting size					
			2	3	4	5	6	
ø4	0.3 (0.35)	LVQ20(H)S-Z	●					
ø8	1.1 (1.3)	LVQ30(H)S-Z		●				
ø10	1.6 (1.9)	LVQ40(H)S-Z			●			
ø16	4.2 (5)	LVQ50(H)S-Z				●		
ø22	6.8 (8)	LVQ60(H)S-Z					●	

## Tube Extension Type *LVQ-T/LVQH-T Series*



Orifice diameter	Flow rate characteristics Kv (Cv)	Series	Tubing size																		
			Metric size				Inch size														
			6	10	12	19	25	1/4	3/8	1/2	3/4	1									
ø4	0.3 (0.35)	LVQ20(H)-T	●																		
ø8	1.1 (1.3)	LVQ30(H)-T		●																	
ø10	1.6 (1.9)	LVQ40(H)-T			●																
ø16	4.2 (5)	LVQ50(H)-T				●															
ø22	6.8 (8)	LVQ60(H)-T					●														

# Guide to Pamphlet on Fluoropolymer Fitting Installation Methods

\* The pamphlets can be downloaded from the SMC home page. <http://www.smcworld.com>

## LQ1/2 Series Installation Method

### R type

For fitting sizes 1 to 6

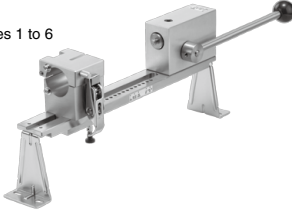

### J type

For fitting sizes 1 and 2



### K type

For fitting sizes 1 and 2

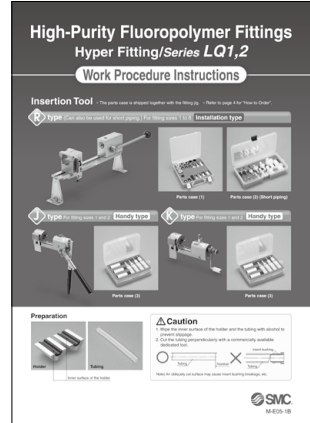

M-E05-1

## LQ3 Series Installation Method

For fitting sizes 2 to 6



For fitting size 1

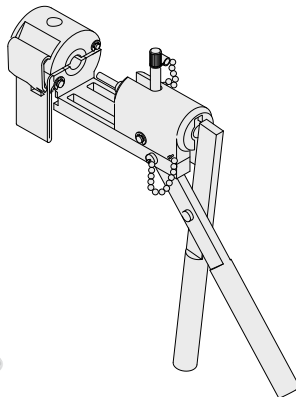

M-E06-4

LVC
LVA
LVB
LVD
<b>LVQ</b>
LVP
LVV
LQ1
LQ3
LVN
LQHB
TL
TIL
TLM
TILM
TD
TID
TH
TIH

# INDEX

## Insert Bushing, Integrated Fitting Type

**Air Operated  
Insert Bushing, Integrated Fitting Type  
Hyper Fitting**

● **LVQ Series**

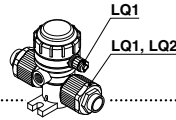

P.778

**Air Operated  
Insert Bushing, Integrated Fitting Type  
Space Saving/Space Saving Connection**

● **LVQS Series**

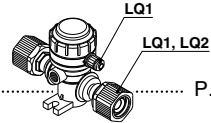

P.786

**Manually Operated  
Insert Bushing, Integrated Fitting Type  
Hyper Fitting**

● **LVQH Series**

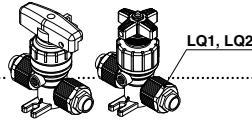

P.795

**Manually Operated  
Insert Bushing, Integrated Fitting Type  
Space Saving/Space Saving Connection**

● **LVQHS Series**

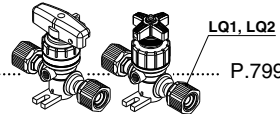

P.799

## Fittings and Special Tools

P.804

## Flare, Integrated Fitting Type

**Air Operated  
Flare, Integrated Fitting Type  
Hyper Fitting**

● **LVQ-Z Series**

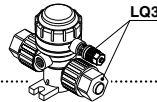

P.805

**Air Operated  
Flare, Integrated Fitting Type  
Space Saving/Space Saving Connection**

● **LVQS-Z Series**

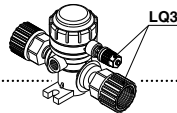

P.813

**Manually Operated  
Flare, Integrated Fitting Type  
Hyper Fitting**

● **LVQH-Z Series**

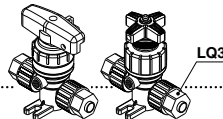

P.822

**Manually Operated  
Flare, Integrated Fitting Type  
Space Saving/Space Saving Connection**

● **LVQHS-Z Series**

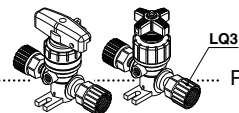

P.826

# INDEX

Tube Extension Type

Air Operated  
Tube Extension Type  
● **LVQ-T Series**

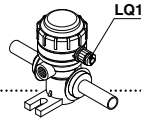

P.831

Manually Operated  
Tube Extension Type  
● **LVQH-T Series**

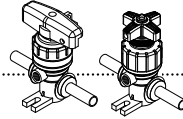

P.838

Insert Bushing,  
Integrated  
Fitting Type

Air Operated, 0.5 MPa Back Pressure Tolerant  
Insert Bushing, Integrated Fitting Type  
Hyper Fitting  
● **LVQ□□H Series**

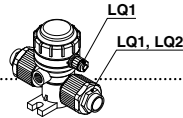

P.841

Flare,  
Integrated  
Fitting Type

Air Operated, 0.5 MPa Back Pressure Tolerant  
Flare, Integrated Fitting Type  
Hyper Fitting  
● **LVQ□□H-Z Series**

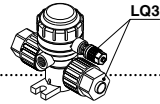

P.842

Applicable Fluids

P.844

Specific Product Precautions

P.845, 846

LVC

LVA

LVH

LVD

**LVQ**

LVP

LVW

LQ1

LQ3

LVN

LQHB

TL

TIL

TLM

TILM

TD

TID

TH

TIH

# Air Operated Insert Bushing, Integrated Fitting Type Hyper Fitting **LVQ Series**

RoHS

## How to Order

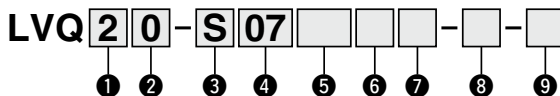

### ① Body class

Symbol	Body class	Orifice dia.
2	2	ø4
3	3	ø8
4	4	ø10
5	5	ø16
6	6	ø22

### ② Valve type

0	N.C.
1	N.O.
2	Double acting

Note) For valve type combinations, refer to variations on the next page.

### ③ Fitting type

Symbol	Fitting type	Body class
V	LQ1	2, 3, 4, 5, 6
S	LQ2	2, 3, 4, 5

Note) Insert bushing is used in common.

### ④ Applicable tubing size<sup>Note)</sup>

Symbol	Connection tubing size	Body class				
		2	3	4	5	6
<b>Metric size</b>						
03	3 x 2	●				
04	4 x 3	●				
06	6 x 4	○	●			
08	8 x 6		●			
10	10 x 8		○	●		
12	12 x 10			○	●	
19	19 x 16				○	●
25	25 x 22					○
<b>Inch size</b>						
03	1/8" x 0.086"	●				
05	3/16" x 1/8"	●				
07	1/4" x 5/32"	○	●			
11	3/8" x 1/4"		○	●		
13	1/2" x 3/8"			○	●	
19	3/4" x 5/8"				○	●
25	1" x 7/8"					○

○ Basic size ● With reducer

Note) Refer to page 846 for details of the applicable tubing sizes.

### ⑤ Port B (OUT) different dia. size

Symbol	Application
Nii	Ports A & B same size
Refer to the applicable tubing size table to the left.	Different diameter tubings can be selected within the same body class.

### ⑥ Pilot port type

Nii	LQ1 integrated fitting	Connection tubing size 1/8" x 0.086" (3 x 2) <sup>Note)</sup>
M	LQ1 integrated fitting	Connection tubing size 4 x 3 <sup>Note)</sup>
R	Threaded	Rc1/8
N	Threaded	NPT1/8

Note) Refer to page 846 for details of the applicable tubing sizes.

### ⑦ Pilot port direction

Symbol	Direction
Nii	①
P2	②
P3	③
P4	④
P5	⑤
P6	⑥
P7	⑦
P8	⑧

#### Pilot port piping direction

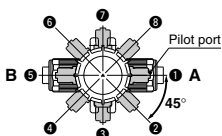

\* Specify the piping direction by part number when ordering the product. Do not change the pilot port direction. (Refer to Precautions on page 846.)



**8 Option 1**

<b>NII</b>	None
<b>1</b>	With flow rate adjustment
<b>2</b>	With by-pass
<b>3</b>	With flow rate adjustment & by-pass
<b>4</b>	With indicator
<b>5</b>	High back pressure (0.42 MPa)
<b>6</b>	High back pressure with flow rate adjustment
<b>7</b>	High back pressure with by-pass
<b>8</b>	High back pressure with flow rate adjustment & by-pass
<b>9</b>	High back pressure with indicator
<b>24</b>	With indicator & by-pass











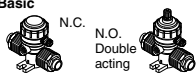
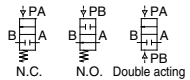

Note) Refer to variations in the table below for valve type and option 1 combinations. Options in the same table can not be combined each other.

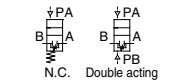
**9 Option 2**

Symbol	Applicable option										Note
	1	2	3	4	5	6	7	8	9	24	
<b>NII</b>	○	○	○	○	○	○	○	○	○	○	—
<b>J</b>	○	—	—	—	—	—	—	—	—	—	For high temperature
<b>K</b>	○	○	○	○	○	○	○	○	○	○	Buffer material FFKM
<b>N</b>	○	○	○	○	○	○	○	○	○	○	For ammonium hydroxide
<b>P</b>	—	—	—	○	○	—	—	—	—	—	High flow type LVQ6□ only

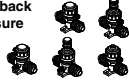
Note 1) Options 2 in the same table cannot be combined each other.  
Note 2) High back pressure specifications (5 to 9) in Option 1 and high temperature specification (J) in Option 2 cannot be combined.

**Variations**

Type	Symbol	Valve type	Model						
			Orifice diameter		LVQ20	LVQ30	LVQ40	LVQ50	LVQ60
			Tubing O.D.		Metric	Inch			
<b>Basic</b> 		N.C. N.O. Double acting Double acting	Orifice diameter ø4	ø8	ø10	ø16	ø22		
			Metric 6	10	12	19	25		
			Inch 1/4	3/8	1/2	3/4	1		
<b>With flow rate adjustment</b> 		N.C.	○	○	○	○	○		
<b>With by-pass</b> 		N.C. Double acting	○	○	○	○	○		
<b>With flow rate adjustment &amp; by-pass</b> 		N.C.	○	○	○	○	○		
<b>With indicator</b> 		N.C.	○	○	○	○	○		
<b>High back pressure</b> 		N.C.	○	○	○	○	○		
<b>With indicator &amp; by-pass</b> 		N.C.	○	○	○	○	○		

- LVC
- LVA
- LVH
- LVJ
- LVQ**
- LVP
- LVW
- LQ1
- LQ3
- LVN
- LQHB
- TL
- TIL
- TLM
- TILM
- TD
- TID
- TH
- TIH

## Standard Specifications



Model		LVQ20	LVQ30	LVQ40	LVQ50	LVQ60
Tubing O.D. <sup>(Note 1)</sup>	Metric	6	10	12	19	25
	Inch	1/4	3/8	1/2	3/4	1
Fitting type	IN/OUT port	LQ1 or LQ2				LQ1
	Pilot port	LQ1				
Orifice diameter		ø4	ø8	ø10	ø16	ø22
Flow rate characteristics	Kv	0.3	1.1	1.6	4.2	6.8 (8.1) <sup>(Note 2)</sup>
	Cv	0.35	1.3	1.9	5	8 (9.5) <sup>(Note 2)</sup>
Withstand pressure (MPa)		1				
Operating pressure <A→B flow>	Standard	-98 kPa to 0.5 MPa <sup>(Note 3)</sup>			-98 kPa to 0.4 MPa <sup>(Note 3)</sup>	
	High temperature	-98 kPa to 0.3 MPa <sup>(Note 3)</sup>				
Back pressure (MPa)	Standard	0.3 or less		0.2 or less		
	High back pressure	0.42 or less				
	High temperature	0.3 or less		0.2 or less		
Valve leakage (cm <sup>3</sup> /min)		0 (With water pressure)				
Pilot air pressure (MPa)		0.3 to 0.5 (High back pressure: 0.45 to 0.55)				
Pilot port size		1/8" (ø3), ø4, Rc 1/8, NPT 1/8				
Fluid temperature (°C)	Standard	0 to 100				
	High temperature	0 to 170				
Ambient temperature (°C)		0 to 60				
Weight (kg)		0.08	0.17	0.22	0.70	0.81

Note 1) Refer to page 846 for details of the applicable tubing sizes.

Note 2) ( ): High flow type

Note 3) This product cannot be used for vacuum retention. Also, connecting the vacuum to the B port may reduce the life of the product.

### ⚠ Specific Product Precautions

Be sure to read this before handling the products. Refer to back page 50 for Safety Instructions and pages 845 and 846 for Air Operated Chemical Liquid Valve Precautions.

#### Piping

### ⚠ Caution

#### 1. Connect tubing by special tools.

For information on tubing connection and special tools, please see the pamphlet "High Purity Fluoropolymer Fittings Hyper Fitting LQ1/2 Series Work Procedure Instructions" (M-E05-1). (The pamphlet can be downloaded from the SMC home page.)

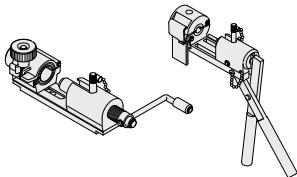

2. Tighten the nut until it touches the end surface of the body, and then tighten it an additional 1/8 turn. If the nut won't turn any further, then it means a sufficient tightening has occurred. Refer to the proper tightening torques shown below.

#### Tightening Torque for Piping

Body class	Torque (N·m)	
	LQ1	LQ2
2	0.3 to 0.4	1.5 to 2.0
3	0.8 to 1.0	3.0 to 3.5
4	1.0 to 1.2	7.5 to 9.0
5	2.5 to 3.0	11.0 to 13.0
6	5.5 to 6.0	—

### Applicable Different Diameter Tubings with Reducer

Different diameter tubings can be selected (within the same body class) by using a nut and an insert bushing (reducer). ● With reducer

Body class	Connection tubing O.D.														
	Metric size						Inch size								
	3	4	6	8	10	12	19	25	1/8	3/16	1/4	3/8	1/2	3/4	1
2	●	●	○	—	—	—	—	—	●	●	○	—	—	—	—
3	—	—	●	●	○	—	—	—	—	●	○	—	—	—	—
4	—	—	—	—	●	○	—	—	—	—	—	●	○	—	—
5	—	—	—	—	—	—	○	○	—	—	—	—	●	○	—
6	—	—	—	—	—	—	—	●	○	—	—	—	—	●	○

Note) Refer to page 804 for information on changing tubing sizes.

LVQ

LVA

LVH

LVD

LVQ

LVP

LVW

LQ1

LQ3

LVN

LQHB

TL

TIL

TLM

TILM

TD

TID

TH

TIH

# LVQ Series

## Construction

### Basic

#### N.C.

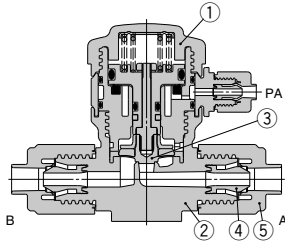

#### N.O.

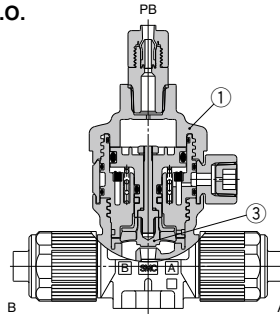

#### Double acting

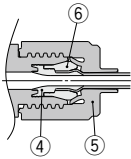
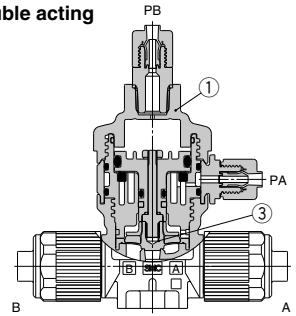

With reducer

#### With flow rate adjustment

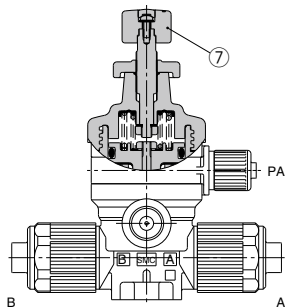

#### With by-pass

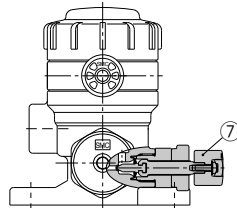

#### With indicator

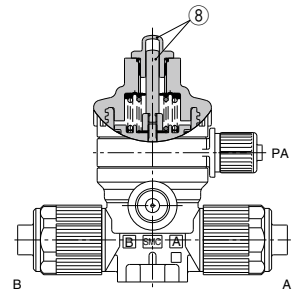

### Component Parts

No.	Description	Material
1	Actuator	PVDF
2	Body	PFA
3	Diaphragm	PTFE
4	Insert bushing	PFA
5	Nut	PFA
6	Collar	PFA
7	Flow rate adjuster	PVDF
8	Indicator/Cover	PP

## Dimensions

**Basic, High back pressure  
N.C. valve**

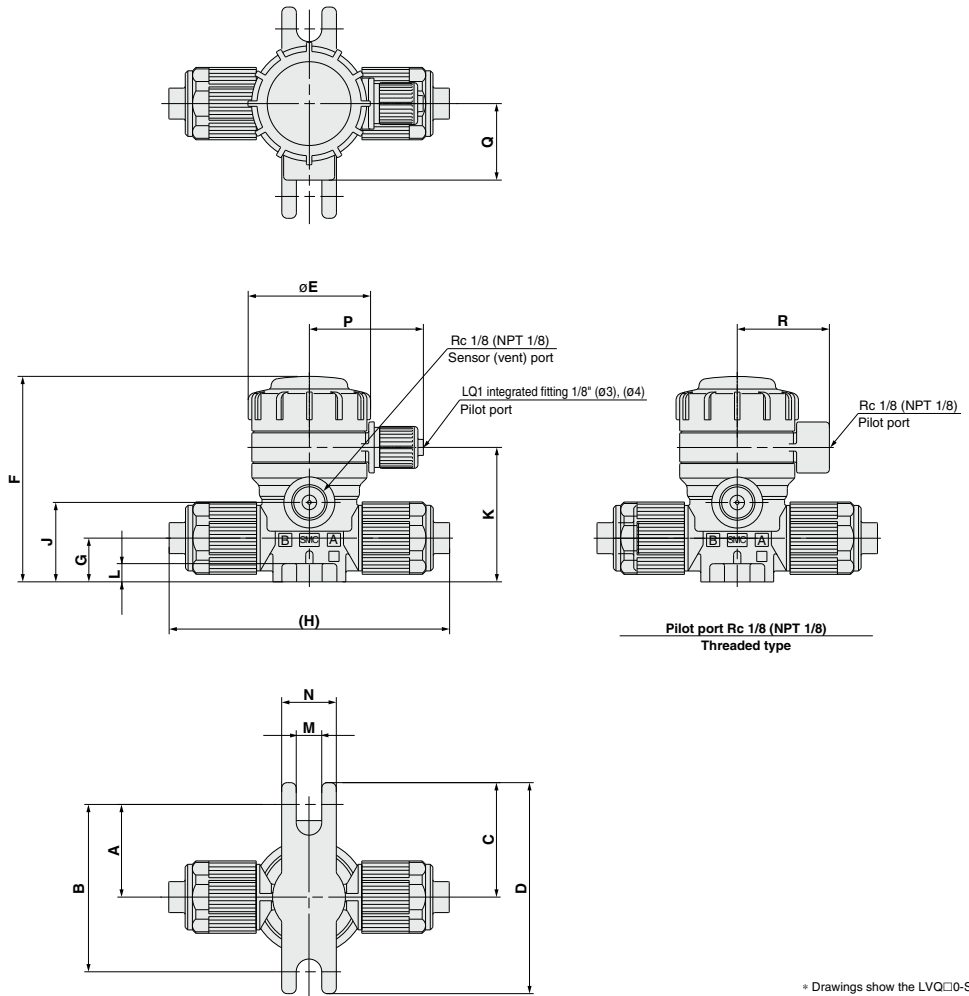

\* Drawings show the LVQ□0-S.

**LVQ□0- $\frac{V}{S}$ □ Dimensions (N.C. Valve)**

(mm)

Model	A	B	C	D	E	F	G	H		J	K	L	M	N	P	Q	R
								V□	S□								
LVQ20- $\frac{V}{S}$ □	25.5	46	31.5	58	33.6	56.5	12	70	77	21.8	37	5	7	15	31.3	21	25.3
LVQ30- $\frac{V}{S}$ □	28.5	57	34.5	69	45.4	77	16.5	83	95	32	50	6	7	20	37.2	25	31.2
LVQ40- $\frac{V}{S}$ □	28.5	57	34.5	69	45.4	82.5	22	95	109	37.5	55.5	6	7	20	37.2	25	31.2
LVQ50- $\frac{V}{S}$ □	42	84	48	96	75	127	25	130	141	50.2	78.2	10	7	20	50.8	38.5	45
LVQ60-V□*	42	84	48	96	75	136.8	32	150	—	60	88	10	7	20	50.8	38.5	45

\* The LVQ60 is available only with "V".

LVC
LVA
LVH
LVD
<b>LVQ</b>
LVP
LVW
LQ1
LQ3
LVN
LQHB
TL
TIL
TLM
TILM
TD
TID
TH
TIH

# LVQ Series

## Dimensions

With flow rate adjustment, High back pressure with flow rate adjustment

N.C. valve

Dimensions (mm)	
Model	S
LVQ20- $\frac{1}{2}$ "□-1	83
LVQ30- $\frac{3}{4}$ "□-1	113.5
LVQ40- $\frac{1}{2}$ "□-1	119
LVQ50- $\frac{3}{4}$ "□-1	171.5
LVQ60-V□-1*	182.5

\* The LVQ60 is available only with "V".

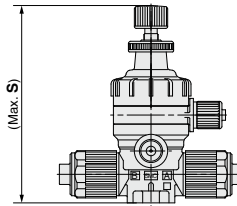

With by-pass, High back pressure with by-pass

N.C. valve

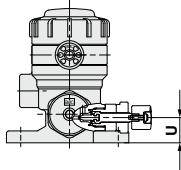
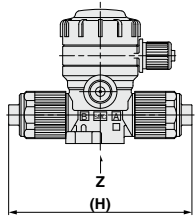
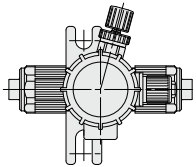

LVQ20

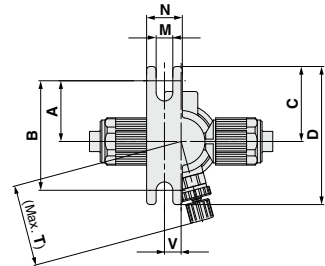

LVQ30, LVQ40  
LVQ50, LVQ60

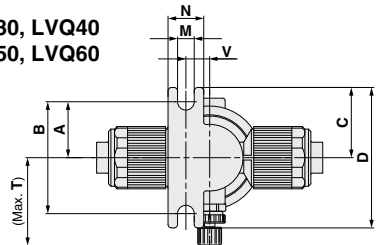

View Z

\* Drawings show the LVQ□0-S.

## Dimensions

Model										H (mm)	
	A	B	C	D	M	N	T	U	V	V□	S□
LVQ20- $\frac{1}{2}$ "□-2	25.5	46	31.5	58	7	15	34.3	10.6	7	64	77
LVQ30- $\frac{3}{4}$ "□-2	25.5	51	31.5	63	7	15	36.9	16.5	10	83	95
LVQ40- $\frac{1}{2}$ "□-2	25.5	51	31.5	63	7	15	37.9	22	10	95	109
LVQ50- $\frac{3}{4}$ "□-2	38	76	44	88	7	20	64	25	17	130	141
LVQ60-V□-2*	38	76	44	88	7	20	66	32	17	150	—

\* The LVQ60 is available only with "V".

With flow rate adjustment & by-pass,  
High back pressure with flow rate adjustment & by-pass  
N.C. valve

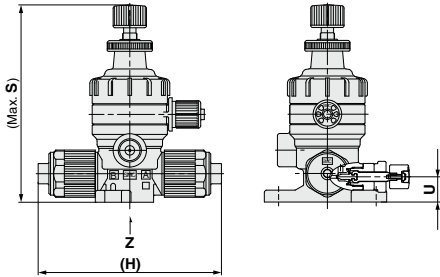
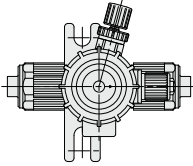

LVQ20

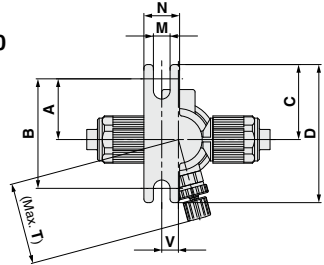

LVQ30, LVQ40  
LVQ50, LVQ60

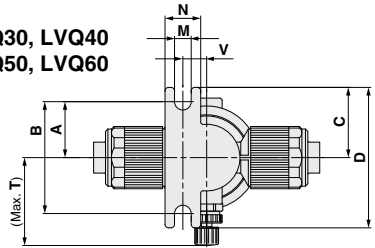

View Z

\* Drawings show the LVQ□0-S.

**Dimensions**

(mm)

Model	A	B	C	D	M	N	S	T	U	V	H	
											V□	S□
LVQ20-□-3	25.5	46	31.5	58	7	15	83	34.3	10.6	7	64	77
LVQ30-□-3	25.5	51	31.5	63	7	15	113.5	36.9	16.5	10	83	95
LVQ40-□-3	25.5	51	31.5	63	7	15	119	37.9	22	10	95	109
LVQ50-□-3	38	76	44	88	7	20	171.5	64	25	17	130	141
LVQ60-V□-3*	38	76	44	88	7	20	182.5	66	32	17	150	—

\* The LVQ60 is available only with "V".

With indicator, High back pressure with indicator  
N.C. valve

**Dimensions**

(mm)

Model	S
LVQ20-□-4	70.5
LVQ30-□-4	88.5
LVQ40-□-4	94
LVQ50-□-4	134.5
LVQ60-V□-4*	144

\* The LVQ60 is available only with "V".

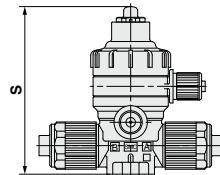

\* Drawings show the LVQ□0-S.

- LVQ
- LVA
- LVH
- LVD
- LVQ**
- LVP
- LVW
- LQ1
- LQ3
- LVN
- LQHB
- TL
- TIL
- TLM
- TILM
- TD
- TID
- TH
- TIH

# LVQ Series

## Dimensions

### Basic N.O. valve

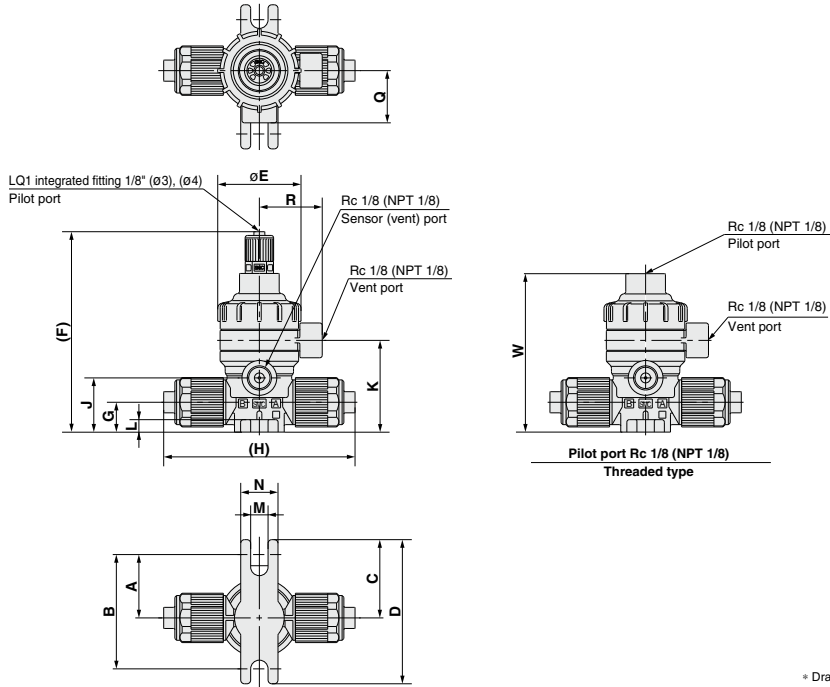

\* Drawings show the LVQ□0-S.

### Double acting valve

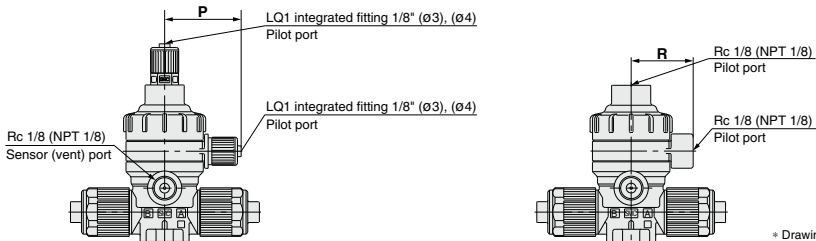

\* Drawings show the LVQ□0-S.

### LVQ□ $\frac{1}{2}$ - $\frac{3}{8}$ □ Dimensions (N.O. Valve, Double Acting Valve)

(mm)

Model	A	B	C	D	E	F	G	H		J	K	L	M	N	P	Q	R	W
								V□	S□									
LVQ2 $\frac{1}{2}$ - $\frac{3}{8}$ □	25.5	46	31.5	58	33.6	81	12	70	77	21.8	37	5	7	15	31.3	21	25.3	64
LVQ3 $\frac{1}{2}$ - $\frac{3}{8}$ □	28.5	57	34.5	69	45.4	99	16.5	83	95	32	50	6	7	20	37.2	25	31.2	82
LVQ4 $\frac{1}{2}$ - $\frac{3}{8}$ □	28.5	57	34.5	69	45.4	104.5	22	95	109	37.5	55.5	6	7	20	37.2	25	31.2	87.5
LVQ5 $\frac{1}{2}$ - $\frac{3}{8}$ □	42	84	48	96	75	145	25	130	141	50.2	78.2	10	7	20	50.8	38.5	45	128
LVQ6 $\frac{1}{2}$ -V□*	42	84	48	96	75	154.5	32	150	—	60	88	10	7	20	50.8	38.5	45	137.5

\* The LVQ60 is available only with "V".

**With by-pass  
Double acting valve**

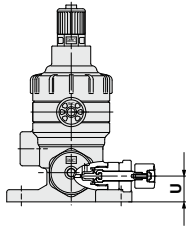
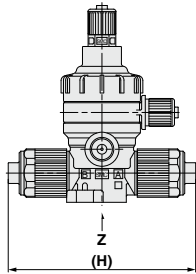
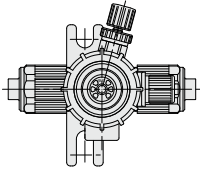

**LVQ2<sub>1</sub><sup>2</sup>**

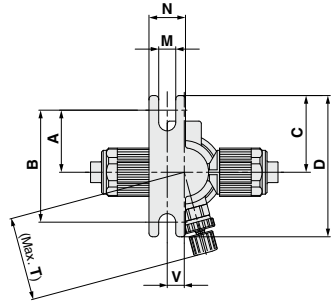

**LVQ3<sub>1</sub><sup>2</sup>, LVQ4<sub>1</sub><sup>2</sup>  
LVQ5<sub>1</sub><sup>2</sup>, LVQ6<sub>1</sub><sup>2</sup>**

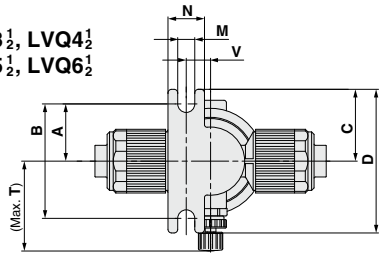

View Z

\* Drawings show the LVQ□0-S.

LVC
LVA
LVH
LVD
<b>LVQ</b>
LVP
LVW
LQ1
LQ3
LVN
LQHB
TL
TIL
TLM
TILM
TD
TID
TH
TIH

**Dimensions (N.O Valve, Double Acting Valve)**

(mm)

Model	A	B	C	D	M	N	T	U	V	H	
										V□	S□
LVQ2 <sub>1</sub> <sup>2</sup> -□-2	25.5	46	31.5	58	7	15	34.3	10.6	7	64	77
LVQ3 <sub>1</sub> <sup>2</sup> -□-2	25.5	51	31.5	63	7	15	36.9	16.5	10	83	95
LVQ4 <sub>1</sub> <sup>2</sup> -□-2	25.5	51	31.5	63	7	15	37.9	22	10	95	109
LVQ5 <sub>1</sub> <sup>2</sup> -□-2	38	76	44	88	7	20	64	25	17	130	141
LVQ6 <sub>1</sub> <sup>2</sup> -V□-2*	38	76	44	88	7	20	66	32	17	150	—

\* The LVQ60 is available only with "V".



# Air Operated Insert Bushing, Integrated Fitting Type Space Saving/Space Saving Connection **LVQS Series**

RoHS

## How to Order

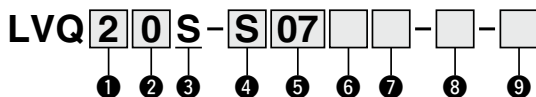

### 1 Body class

Symbol	Body class	Orifice dia.
2	2	ø4
3	3	ø8
4	4	ø10
5	5	ø16
6	6	ø22

### 2 Valve type

0	N.C.
1	N.O.
2	Double acting

Note) For valve type combinations, refer to variations on the next page.

### 3 Body type

S	Space saving connection
---	-------------------------

### 4 Fitting type

Symbol	Fitting type	Body class
V	LQ1	2, 3, 4, 5, 6
S	LQ2	2, 3, 4, 5

Note) Insert bushing is used in common.

### 5 Applicable fitting size

Symbol	Fitting size	Body class					
		2	3	4	5	6	
07	2	○					
11	3		○				
13	4			○			
19	5				○		
25	6					○	

Note) Refer to page 787 for How to Order fitting parts. Select a tube with the same size as the valve side fitting.

### 6 Pilot port type

Nil	LQ1 integrated fitting	Connection tubing size 1/8" x 0.086" (3 x 2) <sup>Note)</sup>
M	LQ1 integrated fitting	Connection tubing size 4 x 3 <sup>Note)</sup>
R	Threaded	Rc1/8
N	Threaded	NPT1/8

Note) Refer to page 846 for details of the applicable tubing sizes.

### 7 Pilot port direction

Symbol	Direction
Nil	1
P2	2
P3	3
P4	4
P5	5
P6	6
P7	7
P8	8

#### Pilot port piping direction

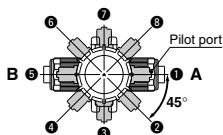

\* Specify the piping direction by part number when ordering the product. Do not change the pilot port direction. (Refer to Precautions on page 846.)

**8 Option 1**

<b>Nii</b>	None
<b>1</b>	With flow rate adjustment
<b>2</b>	With by-pass
<b>3</b>	With flow rate adjustment & by-pass
<b>4</b>	With indicator
<b>5</b>	High back pressure (0.42 MPa)
<b>6</b>	High back pressure with flow rate adjustment
<b>7</b>	High back pressure with by-pass
<b>8</b>	High back pressure with flow rate adjustment & by-pass
<b>9</b>	High back pressure with indicator
<b>24</b>	With indicator & by-pass











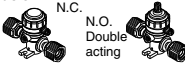
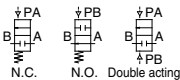

Note) Refer to variations in the table below for valve type and option 1 combinations. Options in the same table can not be combined each other.

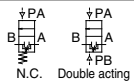
**9 Option 2**

Symbol	Applicable option										Note
	1	2	3	4	5	6	7	8	9	24	
<b>Nii</b>	○	○	○	○	○	○	○	○	○	○	—
<b>J</b>	○	—	—	—	—	—	—	—	—	—	For high temperature
<b>K</b>	○	○	○	○	○	○	○	○	○	○	Buffer material FFKM
<b>N</b>	○	○	○	○	○	○	○	○	○	○	For ammonium hydroxide
<b>P</b>	—	—	—	○	○	—	—	—	—	—	High flow type <b>LVQ6</b> □ only

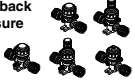
Note 1) Options 2 in the same table cannot be combined each other.  
Note 2) High back pressure specifications (5 to 9) in Option 1 and high temperature specification (J) in Option 2 cannot be combined.

**Variations**

Type	Symbol	Model	LVQ20	LVQ30	LVQ40	LVQ50	LVQ60	
			Orifice diameter					
			Applicable fitting size					
			Model	LVQ20	LVQ30	LVQ40	LVQ50	LVQ60
			Orifice diameter	ø4	ø8	ø10	ø16	ø22
			Applicable fitting size	2	3	4	5	6
			Valve type					
<b>Basic</b>  N.C. Double acting	 N.C. Double acting	N.C.	○	○	○	○	○	
		N.O.	○	○	○	○	○	
		Double acting	○	○	○	○	○	
<b>With flow rate adjustment</b>  N.C.	 N.C.	N.C.	○	○	○	○	○	
<b>With by-pass</b>  N.C. Double acting	 N.C. Double acting	N.C.	○	○	○	○	○	
		Double acting	○	○	○	○	○	
<b>With flow rate adjustment &amp; by-pass</b>  N.C.	 N.C.	N.C.	○	○	○	○	○	
<b>With indicator</b>  N.C.	 N.C.	N.C.	○	○	○	○	○	
<b>High back pressure</b>  N.C.	 N.C.	N.C.	○	○	○	○	○	
<b>With indicator &amp; by-pass</b>  N.C.	 N.C.	N.C.	○	○	○	○	○	

- LVQ
- LVA
- LVH
- LVQ
- LVD
- LVQ
- LVP
- LVW
- LQ1
- LQ3
- LVN
- LQHB
- TL
- TIL
- TLM
- TILM
- TD
- TID
- TH
- TIH

## How to Order Space Saving Fittings

### Applicable tubing size (Note 1) Note 2)

Size	No.	Applicable tubing size (mm)	Reducing
2	1	6 x 4	○
2	2	4 x 3	●
3	1	10 x 8	○
3	2	8 x 6	●
3	3	6 x 4	●
4	1	12 x 10	○
4	2	10 x 8	●
5	1	19 x 16	○
5	2	12 x 10	●
6	1	25 x 22	○
6	2	19 x 16	●

Size	Symbol	Applicable tubing size (inch)	Reducing
2	A	1/4" x 5/32"	○
2	B	3/16" x 1/8"	●
2	C	1/8" x 0.086"	●
3	A	3/8" x 1/4"	○
3	B	1/4" x 5/32"	●
4	A	1/2" x 3/8"	○
4	B	3/8" x 1/4"	●
5	A	3/4" x 5/8"	○
5	B	1/2" x 3/8"	●
6	A	1" x 7/8"	○
6	B	3/4" x 5/8"	●

○ Basic size    ● With reducer

Note 1) Select the same size as the fitting on the valve.

Note 2) Refer to page 846 for details of the applicable tubing sizes.



**LQ1 E 61 - SN - □**  
**LQ2 E 21 - SN - □**

### • Packaging

Symbol	Packaging
Nil	Clean packaging equivalent to Class M3.5
1	Standard packaging equivalent to Class M5.5

• One (including insert bushing) of the nuts is not attached.

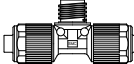
### Fitting type

E	T
Union elbow 	Union tee 
P	U
Panel mount union 	Union 

### Applicable tubing size (Note 1) Note 2)

Size	No.	Applicable tubing size (mm)	Reducing
2	1	6 x 4	○
2	2	4 x 3	●
3	1	10 x 8	○
3	2	8 x 6	●
3	3	6 x 4	●
4	1	12 x 10	○
4	2	10 x 8	●
5	1	19 x 16	○
5	2	12 x 10	●

Size	Symbol	Applicable tubing size (inch)	Reducing
2	A	1/4" x 5/32"	○
2	B	3/16" x 1/8"	●
2	C	1/8" x 0.086"	●
3	A	3/8" x 1/4"	○
3	B	1/4" x 5/32"	●
4	A	1/2" x 3/8"	○
4	B	3/8" x 1/4"	●
5	A	3/4" x 5/8"	○
5	B	1/2" x 3/8"	●

○ Basic size    ● With reducer

Note 1) Select the same size as the fitting on the valve.

Note 2) Refer to page 846 for details of the applicable tubing sizes.

## Piping Example

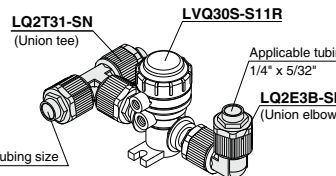

**LQ2T31-SN**  
(Union tee)  
**LVQ30S-S11R**  
 Applicable tubing size  
1/4" x 5/32"  
**LQ2E3B-SN**  
(Union elbow)

Applicable tubing size  
10 x 8

### Ordering Example

**LVQ30S-S11R** 1

**LQ2T31-SN** (Union tee) 1

**LQ2E3B-SN** (Union elbow) 1

Note) For shipment, the valve and fittings are individually packaged and dispatched together in 1 box.



## Standard Specifications

Model		LVQ20S	LVQ30S	LVQ40S	LVQ50S	LVQ60S
Connection fitting size		2	3	4	5	6
Fitting type	IN/OUT port	LQ1 or LQ2				LQ1
	Pilot port	LQ1				
Orifice diameter		ø4	ø8	ø10	ø16	ø22
Flow rate characteristics	Kv	0.3	1.1	1.6	4.2	6.8 (8.1) <sup>Note 1)</sup>
	Cv	0.35	1.3	1.9	5	8 (9.5) <sup>Note 1)</sup>
Withstand pressure (MPa)		1				
Operating pressure <A→B flow>	Standard	-98 kPa to 0.5 MPa <sup>Note 3)</sup>			-98 kPa to 0.4 MPa <sup>Note 3)</sup>	
	High temperature	-98 kPa to 0.3 MPa <sup>Note 3)</sup>				
Back pressure (MPa)	Standard	0.3 or less		0.2 or less		
	High back pressure	0.42 or less				
	High temperature	0.3 or less			0.2 or less	
Valve leakage (cm <sup>3</sup> /min)		0 (With water pressure)				
Pilot air pressure (MPa)		0.3 to 0.5 (High back pressure: 0.45 to 0.55)				
Pilot port size <sup>Note 2)</sup>		1/8" (ø3), ø4, Rc 1/8, NPT 1/8				
Fluid temperature (°C)	Standard	0 to 100				
	High temperature	0 to 170				
Ambient temperature (°C)		0 to 60				
Weight (kg)		0.085	0.175	0.223	0.725	0.835

Note 1) ( ): High flow type

Note 2) Refer to page 846 for details of the applicable tubing sizes.

Note 3) This product cannot be used for vacuum retention. Also, connecting the vacuum to the B port may reduce the life of the product.

## ⚠ Specific Product Precautions

Be sure to read this before handling the products. Refer to back page 50 for Safety Instructions and pages 845 and 846 for Air Operated Chemical Liquid Valve Precautions.

### Piping

## ⚠ Caution

1. Take extra care with the insert bushing when connecting the fittings.
2. Tighten the nut until it touches the end surface of the body, and then tighten it an additional 1/8 turn. If the nut won't turn any further, then it means a sufficient tightening has occurred. Refer to the proper tightening torques shown below.

#### Tightening Torque for Piping

Body class	Torque (N·m)	
	LQ1	LQ2
2	0.3 to 0.4	1.5 to 2.0
3	0.8 to 1.0	3.0 to 3.5
4	1.0 to 1.2	7.5 to 9.0
5	2.5 to 3.0	11.0 to 13.0
6	5.5 to 6.0	—

## Construction

**Basic**  
N.C.

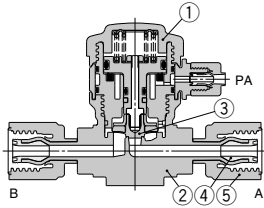

**N.O.**

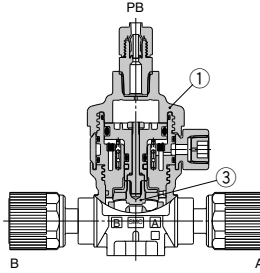

**Double acting**

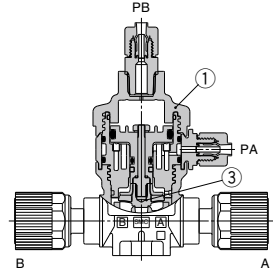

**With flow rate adjustment**

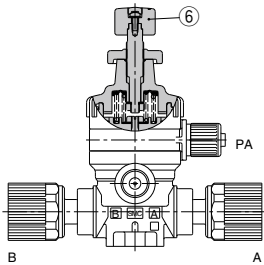

**With by-pass**

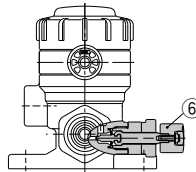

**With indicator**

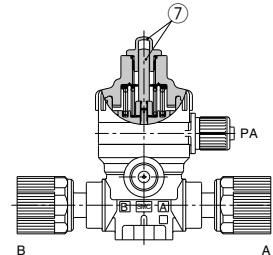

LVQ
LVA
LVH
LVQ
LVQ
LVP
LVW
LQ1
LQ3
LVN
LQHB
TL
TIL
TLM
TILM
TD
TID
TH
TIH

### Component Parts

No.	Description	Material
1	Actuator	PVDF
2	Body	PFA
3	Diaphragm	PTFE
4	Insert bushing	PFA
5	Nut	PFA
6	Flow rate adjuster	PVDF
7	Indicator/Cover	PP

# LVQS Series

## Dimensions

Basic, High back pressure

N.C. valve

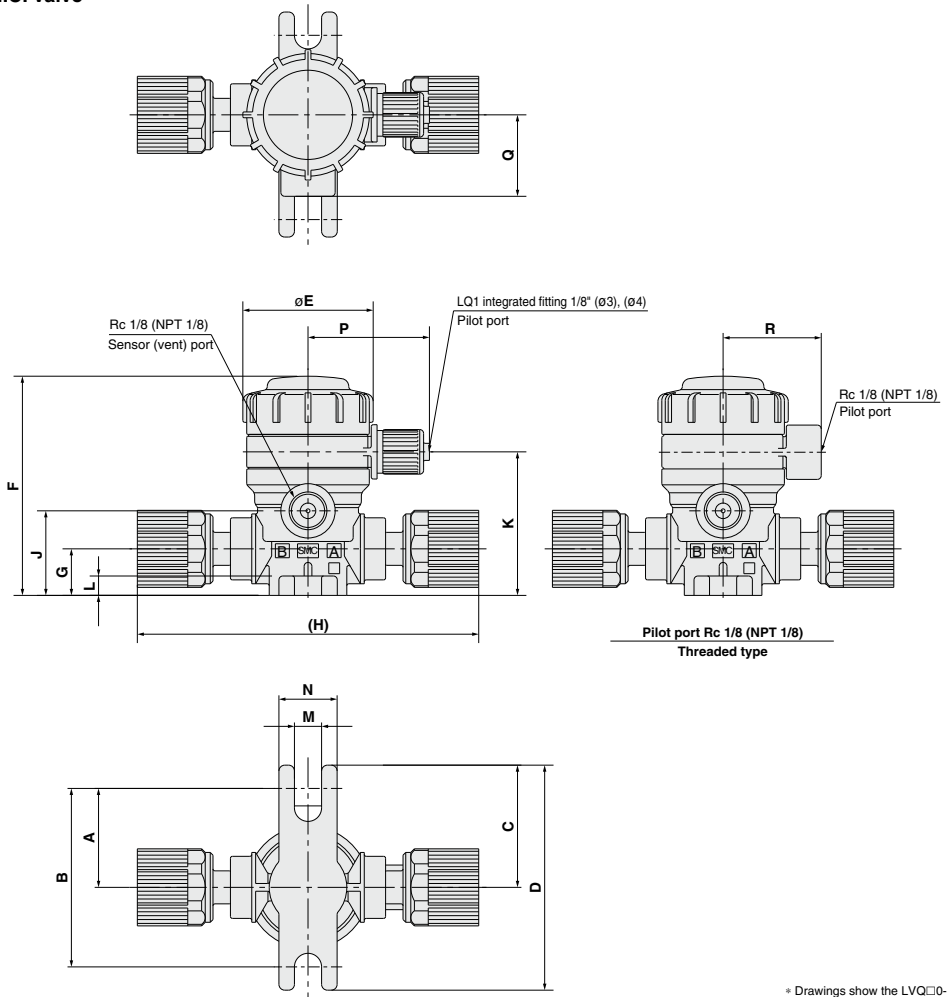

\* Drawings show the LVQ□0-S.

LVQ□0S-V□□ Dimensions (N.C. Valve)

(mm)

Model	A	B	C	D	E	F	G	H		J	K	L	M	N	P	Q	R
								V□	S□								
LVQ20S-V <sup>0</sup> 07	25.5	46	31.5	58	33.6	56.5	12	89	92	21.8	37	5	7	15	31.3	21	25.3
LVQ30S-V <sup>0</sup> 11	28.5	57	34.5	69	45.4	77	16.5	106	112	32	50	6	7	20	37.2	25	31.2
LVQ40S-V <sup>0</sup> 13	28.5	57	34.5	69	45.4	82.5	22	120	126	37.5	55.5	6	7	20	37.2	25	31.2
LVQ50S-V <sup>0</sup> 19	42	84	48	96	75	127	25	164	168	50.2	78.2	10	7	20	50.8	38.5	45
LVQ60S-V25*	42	84	48	96	75	136.8	32	177	—	60	88	10	7	20	50.8	38.5	45

\* The LVQ60 is available only with "V".

**With flow rate adjustment, High back pressure with flow rate adjustment**

**N.C. valve**

Dimensions (mm)	
Model	S
LVQ20S- $\frac{V}{S}$ 07-1	83
LVQ30S- $\frac{V}{S}$ 11-1	113.5
LVQ40S- $\frac{V}{S}$ 13-1	119
LVQ50S- $\frac{V}{S}$ 19-1	171.5
LVQ60S-V25-1*	182.5

\* The LVQ60 is available only with "V".

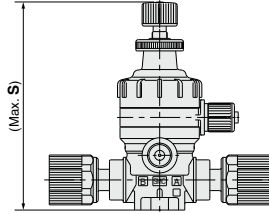

\* Drawing shows the LVQ□0-S.

**With by-pass, High back pressure with by-pass**

**N.C. valve**

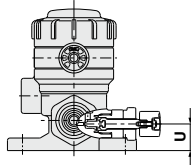
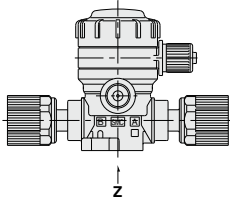
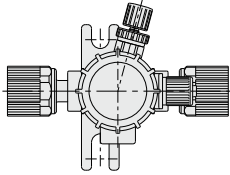

**LVQ20S**

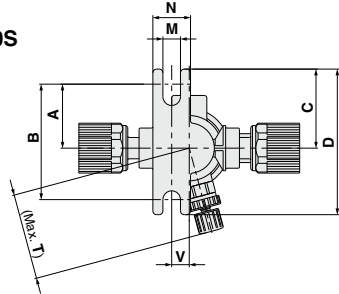

**LVQ30S, LVQ40S  
LVQ50S, LVQ60S**

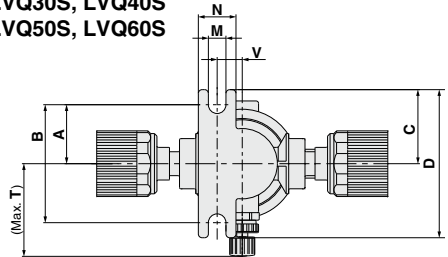

View Z

Dimensions (mm)										
Model	A	B	C	D	M	N	T	U	V	
LVQ20S- $\frac{V}{S}$ 07-2	25.5	46	31.5	58	7	15	34.3	10.6	7	
LVQ30S- $\frac{V}{S}$ 11-2	25.5	51	31.5	63	7	15	36.9	16.5	10	
LVQ40S- $\frac{V}{S}$ 13-2	25.5	51	31.5	63	7	15	37.9	22	10	
LVQ50S- $\frac{V}{S}$ 19-2	38	76	44	88	7	20	64	25	17	
LVQ60S-V25-2*	38	76	44	88	7	20	66	32	17	

\* The LVQ60 is available only with "V".

\* Drawings show the LVQ□0-S.

LVQ
LVA
LVH
LVQ
LVP
LVW
LQ1
LQ3
LVN
LQHB
TL
TIL
TLM
TILM
TD
TID
TH
TIH

# LVQS Series

## Dimensions

With flow rate adjustment & by-pass,  
High back pressure with flow rate adjustment & by-pass  
N.C. valve

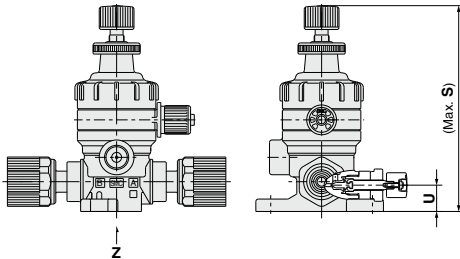
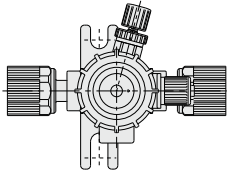

LVQ20S

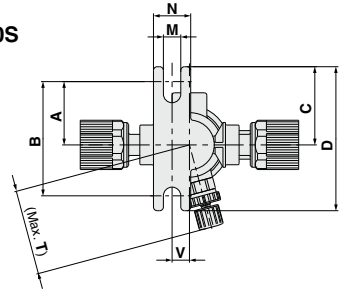

LVQ30S, LVQ40S  
LVQ50S, LVQ60S

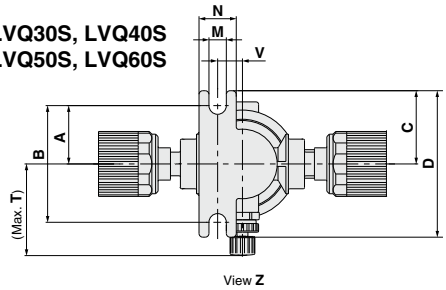

## Dimensions

Model	A	B	C	D	M	N	S	T	U	V
LVQ20S- $\frac{1}{8}$ 07-3	25.5	46	31.5	58	7	15	83	34.3	10.6	7
LVQ30S- $\frac{1}{4}$ 11-3	25.5	51	31.5	63	7	15	113.5	36.9	16.5	10
LVQ40S- $\frac{1}{2}$ 13-3	25.5	51	31.5	63	7	15	119	37.9	22	10
LVQ50S- $\frac{3}{8}$ 19-3	38	76	44	88	7	20	171.5	64	25	17
LVQ60S-V25-3*	38	76	44	88	7	20	182.5	66	32	17

\* The LVQ60 is available only with "V".

\* Drawings show the LVQ□0-S.

With indicator, High back pressure with indicator  
N.C. valve

## Dimensions

Model	S (mm)
LVQ20S- $\frac{1}{8}$ 07-4	70.5
LVQ30S- $\frac{1}{4}$ 11-4	88.5
LVQ40S- $\frac{1}{2}$ 13-4	94
LVQ50S- $\frac{3}{8}$ 19-4	134.5
LVQ60S-V25-4*	144

\* The LVQ60 is available only with "V".

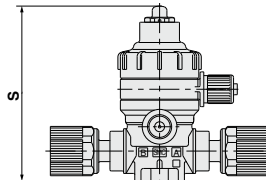

\* Drawing shows the LVQ□0-S.



**Basic  
N.O. valve**

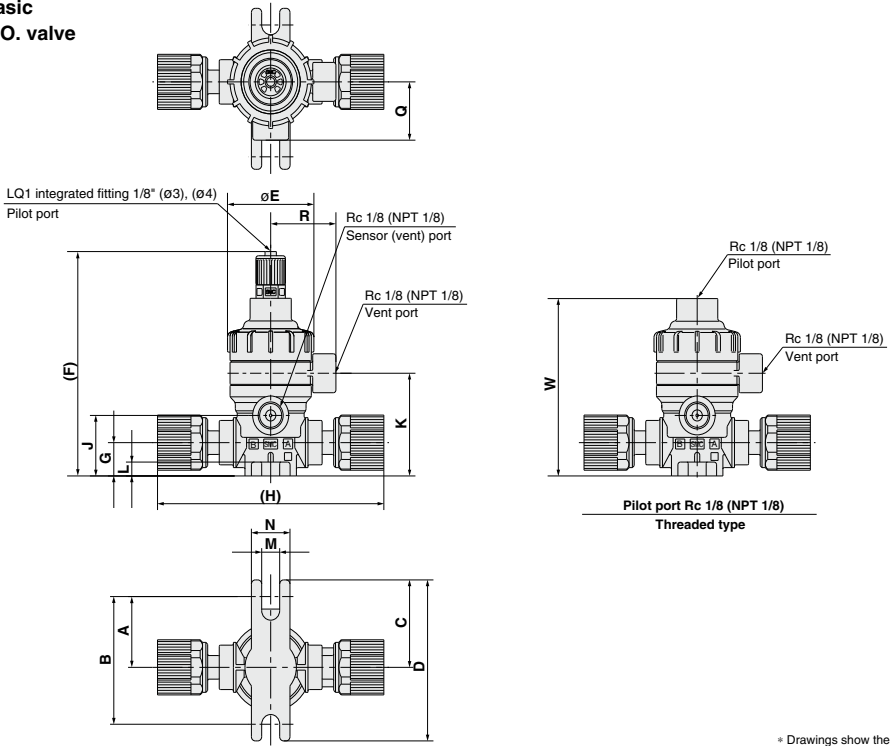

\* Drawings show the LVQ□0-S.

**Double acting valve**

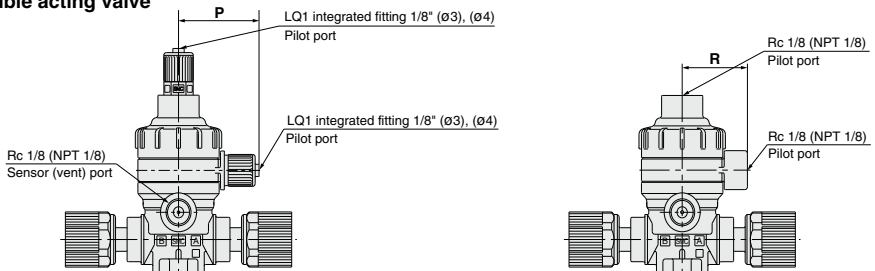

\* Drawings show the LVQ□0-S.

**LVQ□□S□□ Dimensions (N.O. Valve, Double Acting Valve)**

(mm)

Model	A	B	C	D	E	F	G	H		J	K	L	M	N	P	Q	R	W
								V□	S□									
LVQ2□S□07	25.5	46	31.5	58	33.6	81	12	89	92	21.8	37	5	7	15	31.3	21	25.3	64
LVQ3□S□11	28.5	57	34.5	69	45.4	99	16.5	106	112	32	50	6	7	20	37.2	25	31.2	82
LVQ4□S□13	28.5	57	34.5	69	45.4	104.5	22	120	126	37.5	55.5	6	7	20	37.2	25	31.2	87.5
LVQ5□S□19	42	84	48	96	75	145	25	164	168	50.2	78.2	10	7	20	50.8	38.5	45	128
LVQ6□S□V25*	42	84	48	96	75	154.5	32	177	—	60	88	10	7	20	50.8	38.5	45	137.5

\* The LVQ60 is available only with "V".

# LVQS Series

## Dimensions

With by-pass

Double acting valve

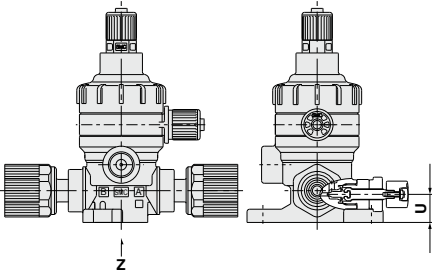
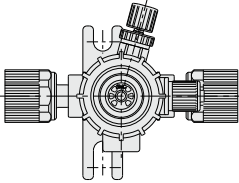

LVQ2 $\frac{1}{2}$ S

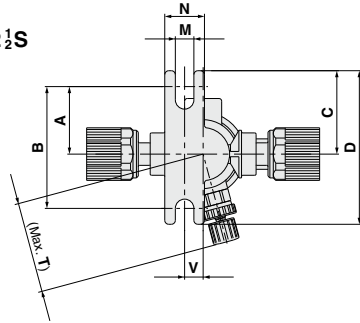

LVQ3 $\frac{1}{2}$ S, LVQ4 $\frac{1}{2}$ S  
LVQ5 $\frac{1}{2}$ S, LVQ6 $\frac{1}{2}$ S

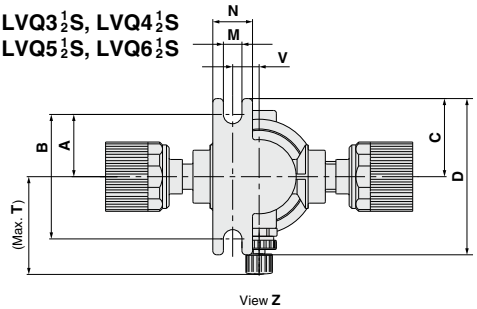

\* Drawings show the LVQ□0-S.

Dimensions (N.O. Valve, Double Acting Valve) (mm)

Model	A	B	C	D	M	N	T	U	V
LVQ2 $\frac{1}{2}$ S- $\frac{1}{8}$ 07-2	25.5	46	31.5	58	7	15	34.3	10.6	7
LVQ3 $\frac{1}{2}$ S- $\frac{1}{8}$ 11-2	25.5	51	31.5	63	7	15	36.9	16.5	10
LVQ4 $\frac{1}{2}$ S- $\frac{1}{8}$ 13-2	25.5	51	31.5	63	7	15	37.9	22	10
LVQ5 $\frac{1}{2}$ S- $\frac{1}{8}$ 19-2	38	76	44	88	7	20	64	25	17
LVQ6 $\frac{1}{2}$ S-V25-2*	38	76	44	88	7	20	66	32	17

\* The LVQ60 is available only with "V".

# Manually Operated Insert Bushing, Integrated Fitting Type Hyper Fitting **LVQH Series**



## How to Order

LVQH **2** 0 - **S** 07       - **1** -   

### Body class

Symbol	Body class	Orifice dia.
2	2	ø4
3	3	ø8
4	4	ø10
5	5	ø16
6	6	ø22

### Option

Symbol	Option
Nil	None
K	Buffer material FFKM
N	For ammonium hydroxide

Note) Options cannot be combined each other.

### Fitting type

Symbol	Fitting type	Body class
V	LQ1	2, 3, 4, 5, 6
S	LQ2	2, 3, 4, 5

### Handle operation

Symbol	Body class
1	90° turn type
4	Multi-turn type (With indicator)

### Vent port type

Symbol	Body class
Nil	Threaded NPT 1/8
R	Threaded Rc 1/8

### Port B (OUT) different dia. size

Symbol	Application
Nil	Ports A & B same size

Refer to the applicable tubing table to the left.





Different diameter tubings can be selected within the same body class.

### Applicable tubing size<sup>Note)</sup>

Symbol	Connection tubing size	Body class					
		2	3	4	5	6	
<b>Metric size</b>							
03	3 x 2	●					
04	4 x 3	●					
06	6 x 4	○	●				
08	8 x 6		●				
10	10 x 8		○	●			
12	12 x 10			○	●		
19	19 x 16				○	●	
25	25 x 22					○	●
<b>Inch size</b>							
03	1/8" x 0.086"	●					
05	3/16" x 1/8"	●					
07	1/4" x 5/32"	○	●				
11	3/8" x 1/4"		○	●			
13	1/2" x 3/8"			○	●		
19	3/4" x 5/8"				○	●	
25	1" x 7/8"					○	●

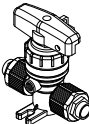
○ Basic size ● With reducer  
Note) Refer to page B46 for details of the applicable tubing sizes.

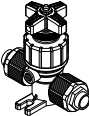
## Variations

Type	Symbol	Model				
		Orifice diameter				
		LVQH20	LVQH30	LVQH40	LVQH50	LVQH60
		Metric				
		Inch				
		1/4	3/8	1/2	3/4	1
90° turn type 		○	○	○	○	○
		○	○	○	○	○
Multi-turn type 		○	○	○	○	○
		○	○	○	○	○

- LVC
- LVA
- LVH
- LVD
- LVQ**
- LVP
- LVW
- LQ1
- LQ3
- LVN
- LQHB
- TL
- TIL
- TLM
- TILM
- TD
- TID
- TH
- TIH

## Standard Specifications



Model		LVQH20	LVQH30	LVQH40	LVQH50	LVQH60
Tubing O.D., <sup>Note 1)</sup>	Metric	6	10	12	19	25
	Inch	1/4	3/8	1/2	3/4	1
Fitting type		LQ1 or LQ2				
Orifice diameter		ø4	ø8	ø10	ø16	ø22
Flow rate characteristics	Kv	0.3	1.1	1.6	4.2	6.8
	Cv	0.35	1.3	1.9	5	8
Withstand pressure (MPa)		1				
Fluid pressure <A→B>		-98 kPa to 0.5 MPa <sup>Note 2)</sup>			-98 kPa to 0.4 MPa <sup>Note 2)</sup>	
Back pressure (MPa)		0.3 or less			0.2 or less	
Valve leakage (cm <sup>3</sup> /min)		0 (With water pressure)				
Fluid temperature (°C)		0 to 100				
Ambient temperature (°C)		0 to 60				
Weight (kg)	LVQH□0-1	0.12	0.27	0.31	1.10	1.16
	LVQH□0-4	0.11	0.20	0.22	0.67	0.87

Note 1) Refer to page 846 for details of the applicable tubing sizes.

Note 2) This product cannot be used for vacuum retention. Also, connecting the vacuum to the B port may reduce the life of the product.

## ⚠ Specific Product Precautions

Be sure to read this before handling the products. Refer to back page 50 for Safety Instructions and pages 845 and 846 for Air Operated Chemical Liquid Valve Precautions.

### Piping

## ⚠ Caution

### 1. Connect tubing by special tools.

For information on tubing connection and special tools, please see the pamphlet "High Purity Fluoropolymer Fittings Hyper Fitting LQ1/2 Series Work Procedure Instructions" (M-E05-1). (The pamphlet can be downloaded from the SMC home page.)

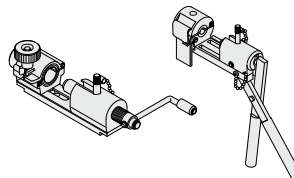

### 2. Tighten the nut until it touches the end surface of the body, and then tighten it an additional 1/8 turn. If the nut won't turn any further, then it means a sufficient tightening has occurred. Refer to the proper tightening torques shown below.

#### Tightening Torque for Piping

Body class	Torque (N·m)	
	LQ1	LQ2
2	0.3 to 0.4	1.5 to 2.0
3	0.8 to 1.0	3.0 to 3.5
4	1.0 to 1.2	7.5 to 9.0
5	2.5 to 3.0	11.0 to 13.0
6	5.5 to 6.0	—

## Construction

### 90° turn type

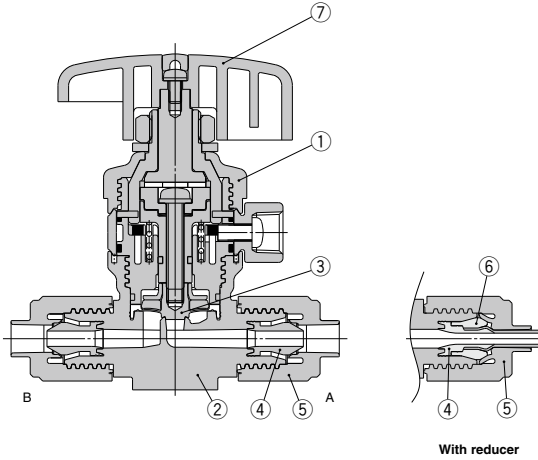

### Multi-turn type (With indicator)

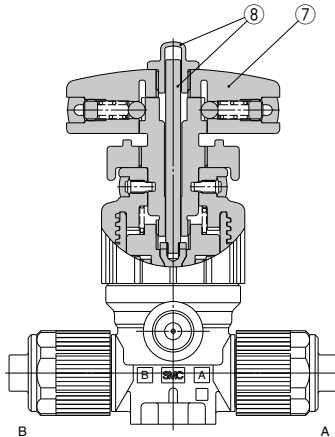

### Component Parts

No.	Description	Material
1	Actuator	PVDF
2	Body	PFA
3	Diaphragm	PTFE
4	Insert bushing	PFA
5	Nut	PFA
6	Collar	PFA
7	Handle	PVDF
8	Indicator/Cover	PP

LVC
LVA
LVH
LVD
<b>LVQ</b>
LVP
LVW
LQ1
LQ3
LVN
LQHB
TL
TIL
TLM
TILM
TD
TID
TH
TIH

# LVQH Series

## Dimensions

### 90° turn type

#### Dimensions

Model	A	B	C	D	F	G	H (mm)	
							V□	S□
LVQH20- $\frac{V}{S}$ □-1	25.5	46	31.5	58	79	12	70	77
LVQH30- $\frac{V}{S}$ □-1	28.5	57	34.5	69	103	16.5	83	95
LVQH40- $\frac{V}{S}$ □-1	28.5	57	34.5	69	108	22	95	109
LVQH50- $\frac{V}{S}$ □-1	42	84	48	96	165	25	130	141
LVQH60-V□-1*	42	84	48	96	175	32	150	—

Model	J	K	L	M	N	Q	Y
LVQH20- $\frac{V}{S}$ □-1	21.8	37	5	7	15	21	55
LVQH30- $\frac{V}{S}$ □-1	32	50	6	7	20	25	80
LVQH40- $\frac{V}{S}$ □-1	37.5	55.5	6	7	20	25	80
LVQH50- $\frac{V}{S}$ □-1	50.2	78.2	10	7	20	38.5	110
LVQH60-V□-1*	60	88	10	7	20	38.5	110

\* The LVQ60 is available only with "V".  
 \* Drawings show the LVQ□0-S.

### Multi-turn type (With indicator)

#### Dimensions

Model	S	Y
LVQH20- $\frac{V}{S}$ □-4	93.6	50
LVQH30- $\frac{V}{S}$ □-4	111.2	50
LVQH40- $\frac{V}{S}$ □-4	116.7	50
LVQH50- $\frac{V}{S}$ □-4	170.7	71
LVQH60-V□-4*	180.2	71

\* The LVQ60 is available only with "V".  
 \* Drawings show the LVQ□0-S.

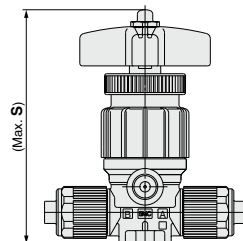
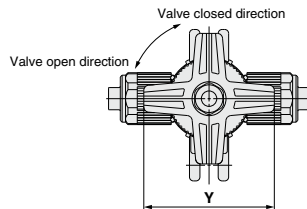
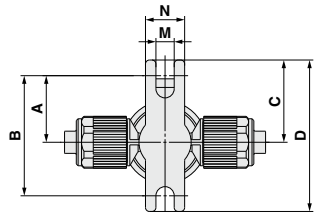
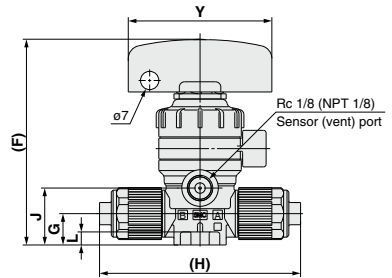
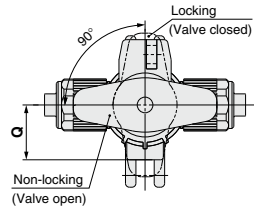

# Manually Operated Insert Bushing, Integrated Fitting Type Space Saving/Space Saving Connection **LVQH Series**



## How to Order

LVQH **2** 0 **S** - **S** **07** - **1** - **□**

**Body class**

Symbol	Body class	Orifice dia.
2	2	ø4
3	3	ø8
4	4	ø10
5	5	ø16
6	6	ø22

**Body type**

S	Space saving connection
---	-------------------------

**Fitting type**

Symbol	Fitting type	Body class
V	LQ1	2, 3, 4, 5, 6
S	LQ2	2, 3, 4, 5

**Option**

Symbol	Option
Nil	None
K	Buffer material FFKM
N	For ammonium hydroxide

Note) Options cannot be combined each other.

**Handle operation**

1	90° turn type
4	Multi-turn type (With indicator)

**Vent port type**

Nil	Threaded	NPT 1/8
R	Threaded	Rc1/8

**Applicable fitting size**

Symbol	Fitting size	Body class					
		2	3	4	5	6	
07	2	○					
11	3		○				
13	4			○			
19	5				○		
25	6					○	

Note) Refer to page 800 for How to Order applicable fittings.  
Select the same size as the fitting on the valve.

## Variations

Model	Orifice diameter	Connection fitting size	LVQH20S	LVQH30S	LVQH40S	LVQH50S	LVQH60S
			Symbol	2	3	4	5
90° turn type			○	○	○	○	○
Multi-turn type			○	○	○	○	○

- LVC
- LVA
- LVH
- LVD
- LVQ**
- LVP
- LVW
- LQ1
- LQ3
- LVN
- LQHB
- TL
- TIL
- TLM
- TILM
- TD
- TID
- TH
- TIH

## How to Order Space Saving Fittings

### Applicable tubing size

Size	No.	Applicable tubing size (mm)	Reducing
2	1	6 x 4	○
2	2	4 x 3	●
3	1	10 x 8	○
3	2	8 x 6	●
3	3	6 x 4	●
4	1	12 x 10	○
4	2	10 x 8	○
5	1	19 x 16	○
5	2	12 x 10	●
6	1	25 x 22	○
6	2	19 x 16	●

Size	Symbol	Applicable tubing size (inch)	Reducing
2	A	1/4" x 5/32"	○
2	B	3/16" x 1/8"	●
2	C	1/8" x 0.086"	●
3	A	3/8" x 1/4"	○
3	B	1/4" x 5/32"	●
4	A	1/2" x 3/8"	○
4	B	3/8" x 1/4"	●
5	A	3/4" x 5/8"	○
5	B	1/2" x 3/8"	●
6	A	1" x 7/8"	○
6	B	3/4" x 5/8"	●

○ Basic size ● With reducer

Note 1) Select the same size as the fitting on the valve.



LQ1 E 61 - SN - □  
LQ2 E 21 - SN - □

### Packaging

Symbol	Packaging
Nil	Clean packaging equivalent to Class M3.5
1	Standard packaging equivalent to Class M5.5

One (including insert bushing) of the nuts is not attached.

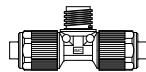
### Fitting type

E	T
Union elbow 	Union tee 
P	U
Panel mount union 	Union 

### Applicable tubing size

Size	No.	Applicable tubing size (mm)	Reducing
2	1	6 x 4	○
2	2	4 x 3	●
3	1	10 x 8	○
3	2	8 x 6	●
3	3	6 x 4	●
4	1	12 x 10	○
4	2	10 x 8	●
5	1	19 x 16	○
5	2	12 x 10	●

Size	Symbol	Applicable tubing size (mm)	Reducing
2	A	1/4" x 5/32"	○
2	B	3/16" x 1/8"	●
2	C	1/8" x 0.086"	●
3	A	3/8" x 1/4"	○
3	B	1/4" x 5/32"	●
4	A	1/2" x 3/8"	○
4	B	3/8" x 1/4"	●
5	A	3/4" x 5/8"	○
5	B	1/2" x 3/8"	●

○ Basic size ● With reducer

Note 1) Select the same size as the fitting on the valve.

## Piping Example

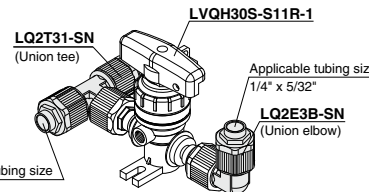

LVQH30S-S11R-1

LQ2T31-SN (Union tee)

LQ2E3B-SN (Union elbow)

Applicable tubing size 1/4" x 5/32"

Applicable tubing size 10 x 8

### Ordering Example

**LVQH30S-S11R-1** 1

**LQ2T31-SN** (Union tee) 1

**LQ2E3B-SN** (Union elbow) 1

Note) For shipment, the valve and fittings are individually packaged and dispatched together in 1 box.



## Standard Specifications



Model		LVQH20S	LVQH30S	LVQH40S	LVQH50S	LVQH60S
Connection fitting size		2	3	4	5	6
Fitting type		LQ1 or LQ2				LQ1
Orifice diameter		ø4	ø8	ø10	ø16	ø22
Flow rate characteristics	Kv	0.3	1.1	1.6	4.2	6.8
	Cv	0.35	1.3	1.9	5	8
Withstand pressure (MPa)		1				
Fluid pressure <A→B>		-98 kPa to 0.5 MPa <sup>Note)</sup>			-98 kPa to 0.4 MPa <sup>Note)</sup>	
Back pressure (MPa)		0.3 or less			0.2 or less	
Valve leakage (cm <sup>3</sup> /min)		0 (With water pressure)				
Fluid temperature (°C)		0 to 100				
Ambient temperature (°C)		0 to 60				
Weight (kg)	LVQH□0S-1	0.14	0.30	0.33	1.14	1.18
	LVQH□0S-4	0.13	0.23	0.24	0.71	0.89

Note) This product cannot be used for vacuum retention. Also, connecting the vacuum to the B port may reduce the life of the product.

## ⚠ Specific Product Precautions

Be sure to read this before handling the products. Refer to back page 50 for Safety Instructions and pages 845 and 846 for Air Operated Chemical Liquid Valve Precautions.

### Piping

## ⚠ Caution

1. Take extra care with the insert bushing when connecting the fittings.
2. Tighten the nut until it touches the end surface of the body, and then tighten it an additional 1/8 turn. If the nut won't turn any further, then it means a sufficient tightening has occurred. Refer to the proper tightening torques shown below.

#### Tightening Torque for Piping

Body class	Torque (N·m)	
	LQ1	LQ2
2	0.3 to 0.4	1.5 to 2.0
3	0.8 to 1.0	3.0 to 3.5
4	1.0 to 1.2	7.5 to 9.0
5	2.5 to 3.0	11.0 to 13.0
6	5.5 to 6.0	—

LVQ

LVA

LVH

LVD

LVQ

LVP

LVW

LQ1

LQ3

LVN

LQHB

TL

TIL

TLM

TILM

TD

TID

TH

TIH

# LVQHS Series

## Construction

### 90° turn type

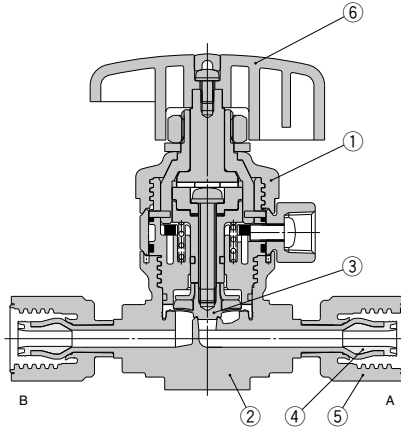

### Multi-turn type (With indicator)

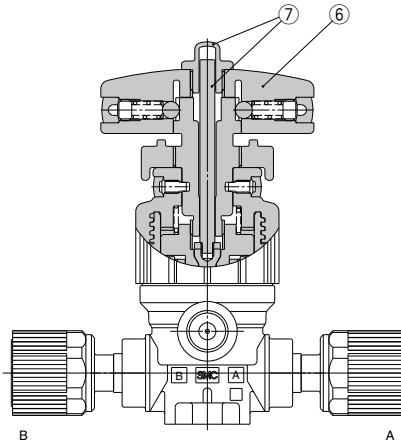

### Component Parts

No.	Description	Material
1	Actuator	PVDF
2	Body	PFA
3	Diaphragm	PTFE
4	Insert bushing	PFA
5	Nut	PFA
6	Handle	PVDF
7	Indicator/Cover	PP

## Dimensions

### 90° turn type

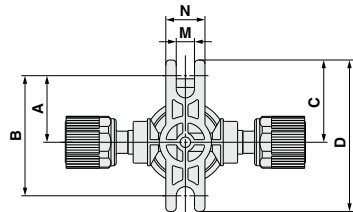
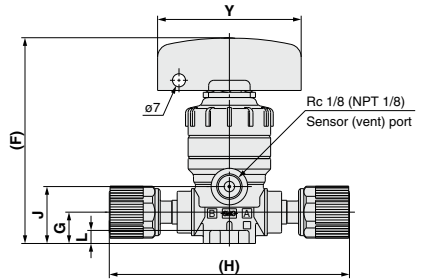
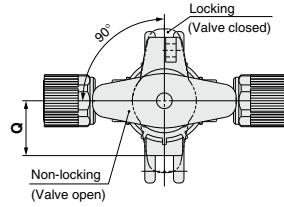

### Dimensions

(mm)

Model	A	B	C	D	F	G	H	
							V□	S□
LVQH20S- $\frac{1}{8}$ □-1	25.5	46	31.5	58	79	12	89	92
LVQH30S- $\frac{1}{8}$ □-1	28.5	57	34.5	69	103	16.5	106	112
LVQH40S- $\frac{1}{8}$ □-1	28.5	57	34.5	69	108	22	120	126
LVQH50S- $\frac{1}{8}$ □-1	42	84	48	96	165	25	164	168
LVQH60S-V□-1*	42	84	48	96	175	32	177	—

Model	J	L	M	N	Q	Y
LVQH20S- $\frac{1}{8}$ □-1	21.8	5	7	15	21	55
LVQH30S- $\frac{1}{8}$ □-1	32	6	7	20	25	80
LVQH40S- $\frac{1}{8}$ □-1	37.5	6	7	20	25	80
LVQH50S- $\frac{1}{8}$ □-1	50.2	10	7	20	38.5	110
LVQH60S-V□-1*	60	10	7	20	38.5	110

\* The LVQ60 is available only with "V".

\* Drawings show the LVQ□0-S.

### Multi-turn type (With indicator)

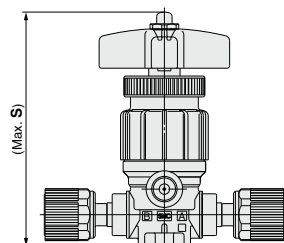
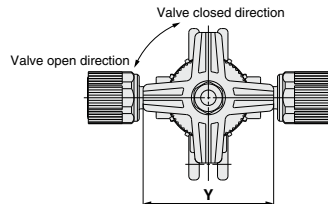

### Dimensions

(mm)

Model	S	Y
LVQH20S- $\frac{1}{8}$ □-4	93.6	50
LVQH30S- $\frac{1}{8}$ □-4	111.2	50
LVQH40S- $\frac{1}{8}$ □-4	116.7	50
LVQH50S- $\frac{1}{8}$ □-4	170.7	71
LVQH60S-V□-4*	180.2	71

\* The LVQ60 is available only with "V".

\* Drawings show the LVQ□0-S.

LVQ

LVA

LVH

LVD

**LVQ**

LVP

LVW

LQ1

LQ3

LVN

LQHB

TL

TIL

TLM

TILM

TD

TID

TH

TIH

## Fittings

### How to Change Tubing Sizes

The tubing size can be changed within the same body class (body size) by replacing the nut and insert bushing.

Body class	Connection tubing O.D.													
	Metric size						Inch size							
	4	6	8	10	12	19	25	1/8	3/16	1/4	3/8	1/2	3/4	1
2	●	○	—	—	—	—	—	●	●	○	—	—	—	—
3	—	●	●	○	—	—	—	—	—	●	○	—	—	—
4	—	—	—	●	○	—	—	—	—	—	●	○	—	—
5	—	—	—	—	●	○	—	—	—	—	—	●	○	—
6	—	—	—	—	—	●	○	—	—	—	—	—	●	○

### Parts Composition

	Component parts		
	Nut	Insert	Collar (insert assembly)
○ Basic size	Yes	Yes	No
● Reducer type	Yes	Yes	Yes

### ⚠ Caution

#### 1. Connect tubing by special tools.

For information on tubing connection and special tools, please see the pamphlet "High Purity Fluoropolymer Fittings Hyper Fitting LQ1/2 Series Work Procedure Instructions" (M-E05-1). (The pamphlet can be downloaded from the SMC home page.)

### Changing the tubing size

Example) Changing the tubing from an O.D. 1/4" to O.D. 1/8" within the body class 2.

Prepare an insert bushing and nut for 1/8" O.D. tubing (LQ-2U03) and change the tubing size.

(Refer to How to Order Fitting Parts.)

Note) Tubing is sold separately.

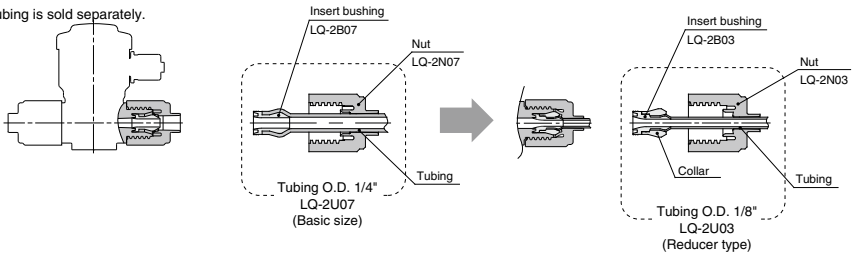

### How to Order Fitting Parts

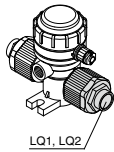

**LQ** 2 **U** 03 \* U type is recommended when changing tubing sizes.

#### Fitting type

Symbol	Applicable fitting
Nil	LQ2
1	LQ1

#### Body class (fittings)

Symbol	Body class (fittings)	Applicable fitting
2	2	LQ1 LQ2
3	3	
4	4	LQ1
5	5	
6	6	

#### Parts type

Symbol	Parts type
U	Nut & Insert bushing
B	Insert bushing
N	Nut

#### Tubing size<sup>Note)</sup>

Symbol	Tubing size	Body class (fittings)	Applicable fitting
03	1/8" x 0.086"(3 x 2)	2	LQ1 LQ2
04	4 x 3		
05	3/16" x 1/8"		
06	6 x 4		
07	1/4" x 5/32"		
06	6 x 4		
08	8 x 6		
10	10 x 8	3	LQ1
07	1/4" x 5/32"		
11	3/8" x 1/4"		

Symbol	Tubing size	Body class (fittings)	Applicable fitting
10	10 x 8	4	LQ1 LQ2
12	12 x 10		
11	3/8" x 1/4"		
13	1/2" x 3/8"		
12	12 x 10	5	LQ1
13	1/2" x 3/8"		
19	3/4" x 5/8", 19 x 16		
19	3/4" x 5/8", 19 x 16	6	LQ1
25	1" x 7/8", 25 x 22		

### For pilot port

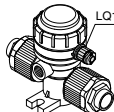

**LQ1** 1 **U** 03

#### Body class (fittings)

Symbol	Body class (fittings)	Applicable fitting
1	1	LQ1

#### Parts type

Symbol	Parts type
U	Nut & Insert bushing
B	Insert bushing
N	Nut

#### Tubing size<sup>Note 1) Note 2)</sup>

Symbol	Tubing size	Body class (fittings)
03	1/8" x 0.086"(3 x 2)	1
04	4 x 3	

Note 1) Cannot change to tubing with different diameter.  
Note 2) Refer to page 846 for details of the applicable tubing sizes.

# Air Operated Flare, Integrated Fitting Type Hyper Fitting **LVQ-Z Series**



## How to Order

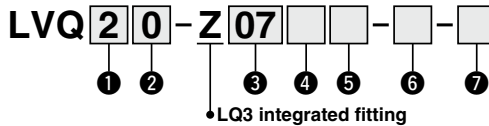

### 1 Body class

Symbol	Body class	Orifice dia.
<b>2</b>	2	ø4
<b>3</b>	3	ø8
<b>4</b>	4	ø10
<b>5</b>	5	ø16
<b>6</b>	6	ø22

### 4 Pilot port type

<b>NII</b>	With LQ3 fitting	Connection tubing size 1/8" x 0.086" (3 x 2) <sup>(Note)</sup>
<b>M</b>	With LQ3 fitting	Connection tubing size 4 x 3 <sup>(Note)</sup>
<b>R</b>	Threaded	Rc1/8
<b>N</b>	Threaded	NPT1/8

Note) Refer to page 846 for details of the applicable tubing sizes.

### 2 Valve type

<b>0</b>	N.C.
<b>1</b>	N.O.
<b>2</b>	Double acting

Note) For valve type combinations, refer to variations on the next page.

### 5 Pilot port direction

Symbol	Direction
<b>NII</b>	<b>1</b>
<b>P2</b>	<b>2</b>
<b>P3</b>	<b>3</b>
<b>P4</b>	<b>4</b>
<b>P5</b>	<b>5</b>
<b>P6</b>	<b>6</b>
<b>P7</b>	<b>7</b>
<b>P8</b>	<b>8</b>

#### Pilot port piping direction

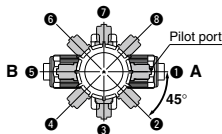

\* Specify the piping direction by part number when ordering the product. Do not change the pilot port direction. (Refer to Precautions on page 846.)

### 3 Applicable tubing size<sup>(Note)</sup>

Symbol	Connection tubing size	Body class					
		2	3	4	5	6	
<b>Metric size</b>							
<b>03</b>	3 x 2	○					
<b>04</b>	4 x 3	○					
<b>06</b>	6 x 4	○					
<b>08</b>	8 x 6		○				
<b>10</b>	10 x 8		○				
<b>12</b>	12 x 10			○			
<b>19</b>	19 x 16				○		
<b>25</b>	25 x 22					○	
<b>Inch size</b>							
<b>03</b>	1/8" x 0.086"	○					
<b>07</b>	1/4" x 5/32"	○					
<b>11</b>	3/8" x 1/4"		○				
<b>13</b>	1/2" x 3/8"			○			
<b>19</b>	3/4" x 5/8"				○		
<b>25</b>	1" x 7/8"					○	

Note) Refer to page 846 for details of the applicable tubing sizes.

**6 Option 1**

<b>NII</b>	None
<b>1</b>	With flow rate adjustment
<b>2</b>	With by-pass
<b>3</b>	With flow rate adjustment & by-pass
<b>4</b>	With indicator
<b>5</b>	High back pressure (0.42 MPa)
<b>6</b>	High back pressure with flow rate adjustment
<b>7</b>	High back pressure with by-pass
<b>8</b>	High back pressure with flow rate adjustment & by-pass
<b>9</b>	High back pressure with indicator
<b>24</b>	With indicator & by-pass









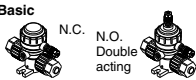
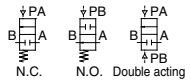

Note) Refer to variations in the table below for valve type and option 1 combinations. Options in the same table can not be combined each other.

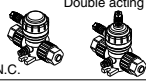
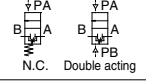
**7 Option 2**

Symbol	Applicable option										Note
	1	2	3	4	5	6	7	8	9	24	
<b>NII</b>	○	○	○	○	○	○	○	○	○	○	—
<b>J</b>	○	—	—	—	—	—	—	—	—	—	For high temperature
<b>K</b>	○	○	○	○	○	○	○	○	○	○	Buffer material FFKM
<b>N</b>	○	○	○	○	○	○	○	○	○	○	For ammonium hydroxide
<b>P</b>	—	—	—	○	○	—	—	—	—	—	High flow type LVQ6□ only

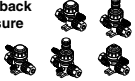
Note 1) Options 2 in the same table cannot be combined each other.  
Note 2) High back pressure specifications (5 to 9) in Option 1 and high temperature specification (J) in Option 2 cannot be combined.

**Variations**

Type	Symbol	Valve type	Model											
			Orifice diameter		LVQ20	LVQ30	LVQ40	LVQ50	LVQ60					
			Metric	Inch	ø4	ø8	ø10	ø16	ø22					
Tubing O.D.			Metric		Inch									
			6		1/4		3/8		1/2		3/4		1	
<b>Basic</b>  N.C. N.O. Double acting	 N.C. N.O. Double acting	N.C.	N.C.	○	○	○	○	○						
			N.O.	○	○	○	○	○						
			Double acting	○	○	○	○	○						
<b>With flow rate adjustment</b> 	 N.C.	N.C.	○	○	○	○	○							
<b>With by-pass</b> Double acting  N.C.	 N.C. Double acting	N.C.	○	○	○	○	○							
		Double acting	○	○	○	○	○							
<b>With flow rate adjustment &amp; by-pass</b> 	 N.C.	N.C.	○	○	○	○	○							
<b>With indicator</b> 	 N.C.	N.C.	○	○	○	○	○							
<b>High back pressure</b> 	 N.C.	N.C.	○	○	○	○	○							
<b>With indicator &amp; by-pass</b> 	 N.C.	N.C.	○	○	○	○	○							

- LVC
- LVA
- LVH
- LVQ
- LVP
- LVW
- LQ1
- LQ3
- LVN
- LQHB
- TL
- TIL
- TLM
- TID
- TIH



## Standard Specifications

Model		LVQ20	LVQ30	LVQ40	LVQ50	LVQ60
Tubing O.D. <sup>Note 1)</sup>	Metric	6	10	12	19	25
	Inch	1/4	3/8	1/2	3/4	1
Orifice diameter		ø4	ø8	ø10	ø16	ø22
Flow rate characteristics	Kv	0.3	1.1	1.6	4.2	6.8 (8.1) <sup>Note 2)</sup>
	Cv	0.35	1.3	1.9	5	8 (9.5) <sup>Note 2)</sup>
Withstand pressure (MPa)		1				
Operating pressure <A→B flow>	Standard	-98 kPa to 0.5 MPa <sup>Note 3)</sup>			-98 kPa to 0.4 MPa <sup>Note 3)</sup>	
	High temperature	-98 kPa to 0.3 MPa <sup>Note 3)</sup>				
Back pressure (MPa)	Standard	0.3 or less		0.2 or less		
	High back pressure	0.42 or less				
	High temperature	0.3 or less			0.2 or less	
Valve leakage (cm <sup>3</sup> /min)		0 (With water pressure)				
Pilot air pressure (MPa)		0.3 to 0.5 (High back pressure: 0.45 to 0.55)				
Pilot port size		1/8" (ø3), Rc 1/8, NPT 1/8				
Fluid temperature (°C)	Standard	0 to 100				
	High temperature	0 to 170				
Ambient temperature (°C)		0 to 60				
Weight (kg)		0.08	0.18	0.22	0.72	0.87

Note 1) Refer to page 846 for details of the applicable tubing sizes.

Note 2) ( ): High flow type

Note 3) This product cannot be used for vacuum retention. Also, connecting the vacuum to the B port may reduce the life of the product.

## ⚠ Specific Product Precautions

Be sure to read this before handling the products. Refer to back page 50 for Safety Instructions and pages 845 and 846 for Air Operated Chemical Liquid Valve Precautions.

### Piping

## ⚠ Caution

### 1. Connect tubing by special tools.

For information on tubing fittings and special tools, please see the pamphlet "High Purity Fluoropolymer Fittings Hyper Fitting/Flare Type LQ3 Series Fitting Procedure" (M-E06-4). (The pamphlet can be downloaded from the SMC home page.)

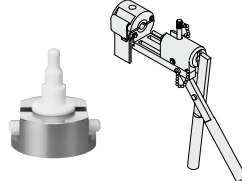

### 2. Tighten the nut until it touches the end surface of the body, and then tighten it an additional 1/8 turn. If the nut won't turn any further, then it means a sufficient tightening has occurred. Refer to the proper tightening torques shown below.

#### Tightening Torque for Piping

Body class	Torque (N·m)
2	1.6 to 1.8
3	3.2 to 3.5
4	5.0 to 5.3
5	10.0 to 10.5
6	22.5 to 23.0

## Construction

### Basic

N.C.

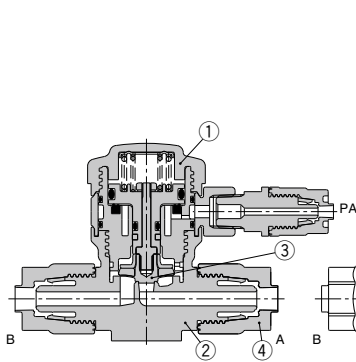

N.O.

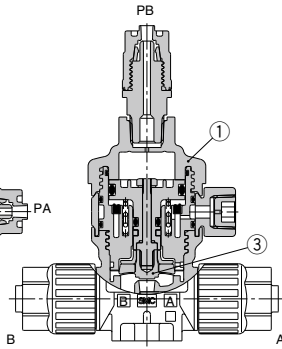

Double acting

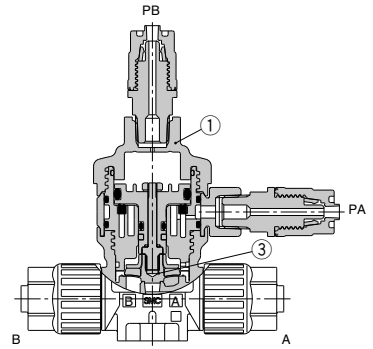

With flow rate adjustment

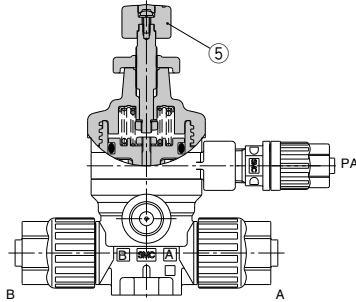

With by-pass

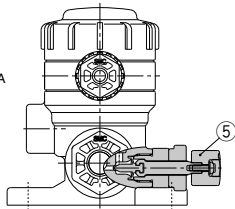

With indicator

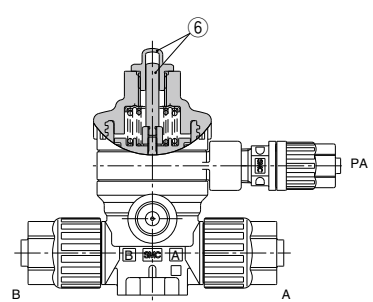

### Component Parts

No.	Description	Material
1	Actuator	PVDF
2	Body	PFA
3	Diaphragm	PTFE
4	Nut	PFA
5	Flow rate adjuster	PVDF
6	Indicator/Cover	PP

LVC
LVA
LVH
LVD
<b>LVQ</b>
LVP
LVW
LQ1
LQ3
LVN
LQHB
TL
TIL
TLM
TILM
TD
TID
TH
TIH



# LVQ-Z Series

## Dimensions

### Basic, High back pressure

#### N.C. valve

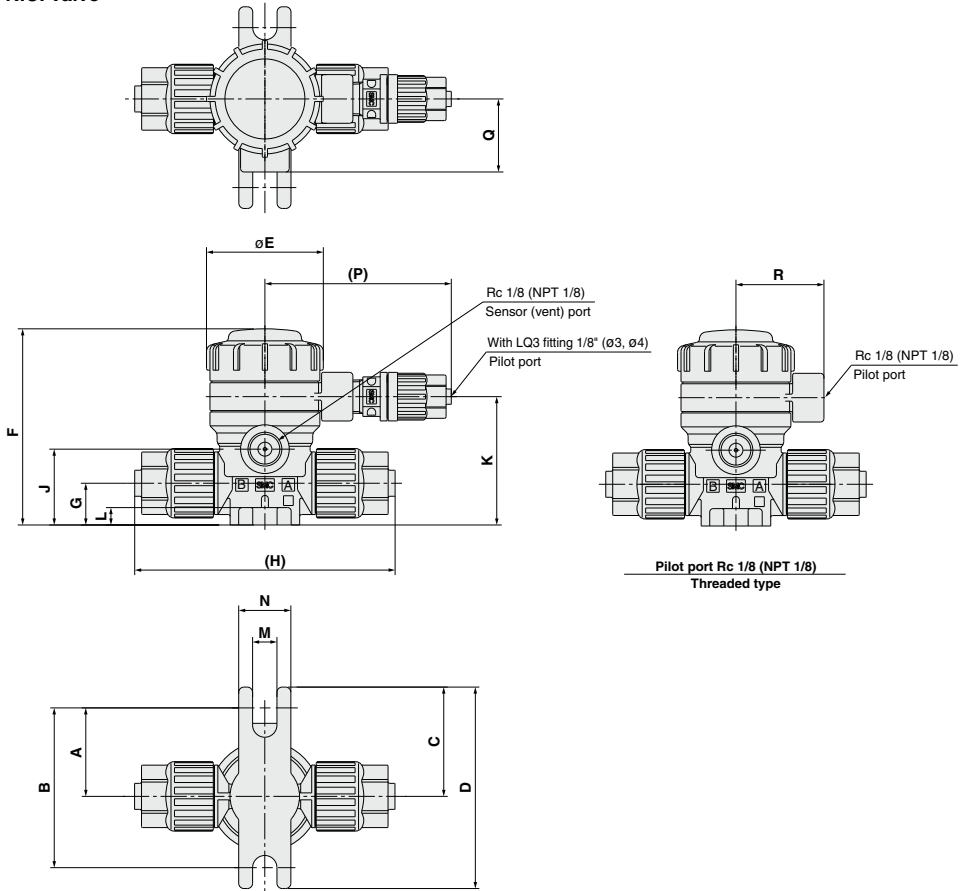

LVQ□0-Z□□□ Dimensions (N.C. Valve)

Model	A	B	C	D	E	F	G	H	J	K	L	M	N	P	Q	R
LVQ20-Z□□□	25.5	46	31.5	58	33.6	56.5	12	75	21.8	37	5	7	15	53.5	21	25.3
LVQ30-Z□□□	28.5	57	34.5	69	45.4	77	16.5	103	32	50	6	7	20	59.5	25	31.2
LVQ40-Z□□□	28.5	57	34.5	69	45.4	82.5	22	114	37.5	55.5	6	7	20	59.5	25	31.2
LVQ50-Z□□□	42	84	48	96	75	127	25	150	50.2	78.2	10	7	20	73	38.5	45
LVQ60-Z□□□	42	84	48	96	75	136.8	32	167	60	88	10	7	20	73	38.5	45

With flow rate adjustment  
N.C. valve

Dimensions (mm)

Model	S
LVQ20-Z□□-1	83
LVQ30-Z□□-1	113.5
LVQ40-Z□□-1	119
LVQ50-Z□□-1	171.5
LVQ60-Z□□-1	182.5

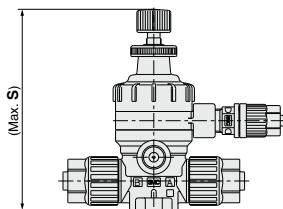

With by-pass  
N.C. valve

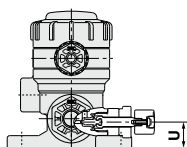
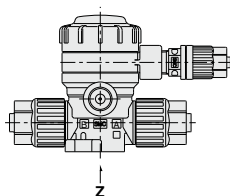
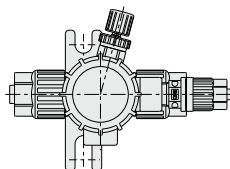

LVQ20

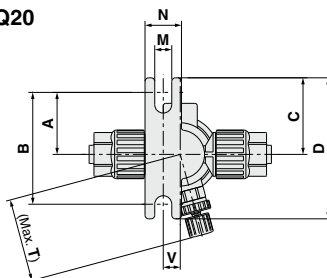

LVQ30, LVQ40  
LVQ50, LVQ60

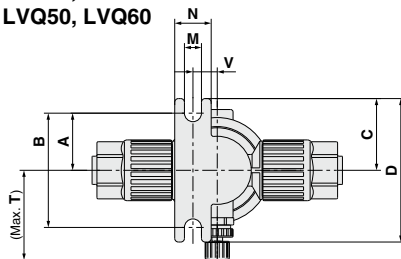

View Z

Dimensions

Model	A	B	C	D	M	N	T	U	V
LVQ20-Z□□-2	25.5	46	31.5	58	7	15	34.3	10.6	7
LVQ30-Z□□-2	25.5	51	31.5	63	7	15	36.9	16.5	10
LVQ40-Z□□-2	25.5	51	31.5	63	7	15	37.9	22	10
LVQ50-Z□□-2	38	76	44	88	7	20	64	25	17
LVQ60-Z□□-2	38	76	44	88	7	20	66	32	17

LVC
LVA
LVH
LVJ
LVK
LVQ
LVP
LVW
LQ1
LQ3
LVN
LQHB
TL
TIL
TLM
TILM
TD
TID
TH
TIH

# LVQ-Z Series

## Dimensions

With flow rate adjustment & by-pass

N.C. valve

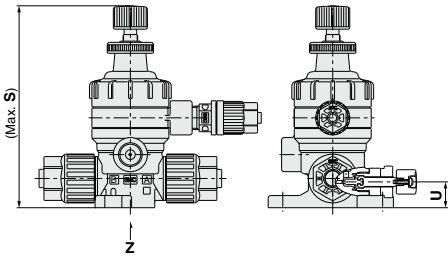
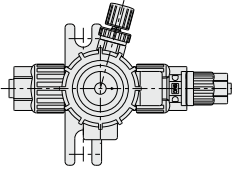

LVQ20

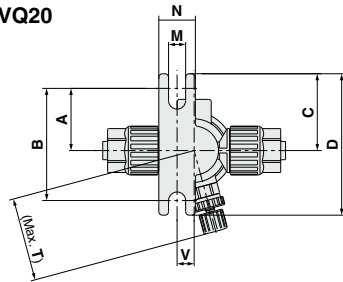

LVQ30, LVQ40  
LVQ50, LVQ60

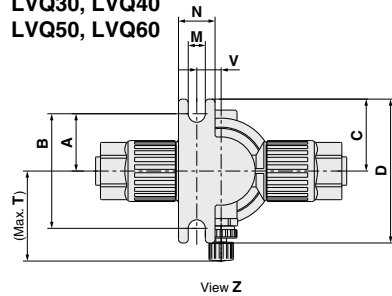

## Dimensions

(mm)

Model	A	B	C	D	M	N	S	T	U	V
LVQ20-Z□□-3	25.5	46	31.5	58	7	15	83	34.3	10.6	7
LVQ30-Z□□-3	25.5	51	31.5	63	7	15	113.5	36.9	16.5	10
LVQ40-Z□□-3	25.5	51	31.5	63	7	15	119	37.9	22	10
LVQ50-Z□□-3	38	76	44	88	7	20	171.5	64	25	17
LVQ60-Z□□-3	38	76	44	88	7	20	182.5	66	32	17

With indicator

N.C. valve

## Dimensions

(mm)

Model	S
LVQ20-Z□□-4	70.5
LVQ30-Z□□-4	88.5
LVQ40-Z□□-4	94
LVQ50-Z□□-4	134.5
LVQ60-Z□□-4	144

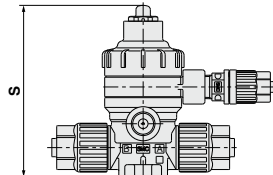

**Basic**  
**N.O. valve**

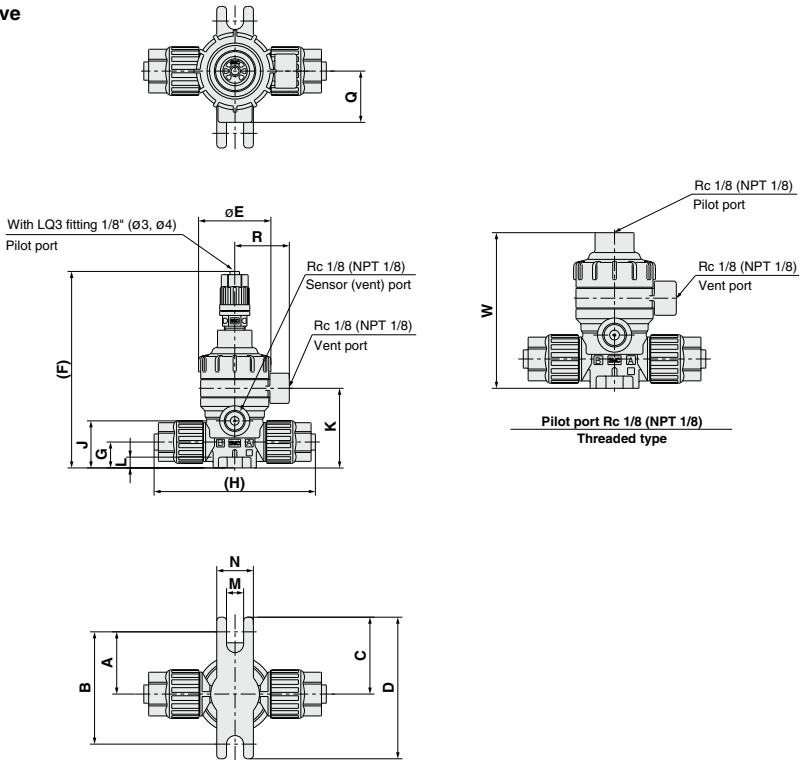

**Double acting valve**

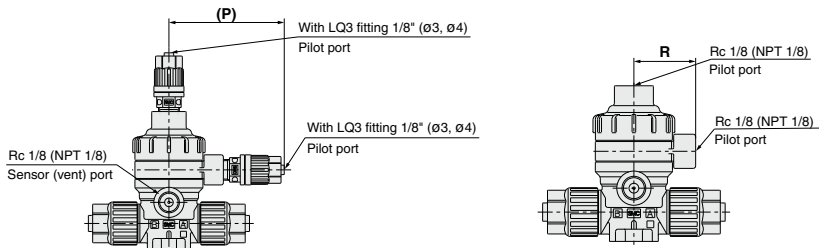

**LVQ□<sub>2</sub>-Z□□□ Dimensions (N.O. Valve, Double Acting Valve)**

Model	A	B	B	D	E	F	G	H	J	K	L	M	N	P	Q	R	W
LVQ2 <sub>2</sub> -Z□□□	25.5	46	31.5	58	33.6	89.5	12	75	21.8	37	5	7	15	53.5	21	25.3	64
LVQ3 <sub>2</sub> -Z□□□	28.5	57	34.5	69	45.4	107.5	16.5	103	32	50	6	7	20	59.5	25	31.2	82
LVQ4 <sub>2</sub> -Z□□□	28.5	57	34.5	69	45.4	113	22	114	37.5	55.5	6	7	20	59.5	25	31.2	87.5
LVQ5 <sub>2</sub> -Z□□□	42	84	48	96	75	153.2	25	150	50.2	78.2	10	7	20	73	38.5	45	128
LVQ6 <sub>2</sub> -Z□□□	42	84	48	96	75	163	32	167	60	88	10	7	20	73	38.5	45	137.5

LVQ
LVA
LVH
LVD
<b>LVQ</b>
LVP
LVW
LQ1
LQ3
LVN
LQHB
TL
TIL
TLM
TILM
TD
TID
TH
TIH

# LVQ-Z Series

## Dimensions

With by-pass

Double acting valve

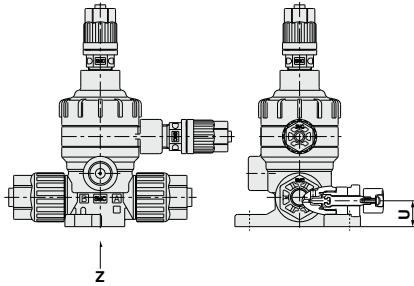
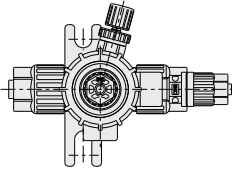

LVQ2<sub>1/2</sub>

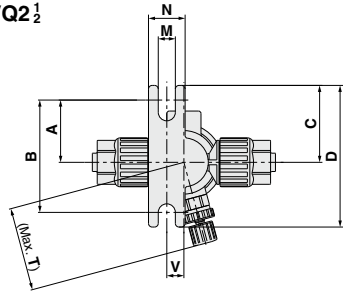

LVQ3<sub>1/2</sub>, LVQ4<sub>1/2</sub>  
LVQ5<sub>1/2</sub>, LVQ6<sub>1/2</sub>

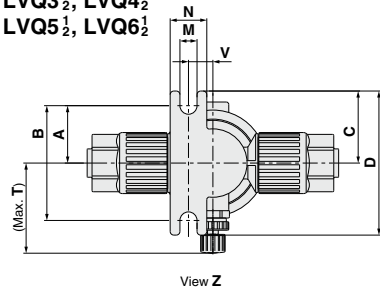

Dimensions (N.O Valve, Double Acting Valve)

(mm)

Model	A	B	C	D	M	N	T	U	V
LVQ2 <sub>1/2</sub> -Z□□-2	25.5	46	31.5	58	7	15	34.3	10.6	7
LVQ3 <sub>1/2</sub> -Z□□-2	25.5	51	31.5	63	7	15	36.9	16.5	10
LVQ4 <sub>1/2</sub> -Z□□-2	25.5	51	31.5	63	7	15	37.9	22	10
LVQ5 <sub>1/2</sub> -Z□□-2	38	76	44	88	7	20	64	25	17
LVQ6 <sub>1/2</sub> -Z□□-2	38	76	44	88	7	20	66	32	17

# Air Operated Flare, Integrated Fitting Type Space Saving/Space Saving Connection **LVQS-Z Series**

RoHS

## How to Order

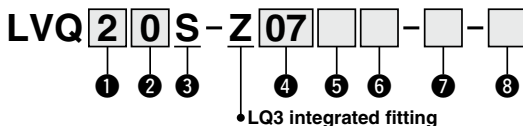

### 1 Body class

Symbol	Body class	Orifice dia.
2	2	ø4
3	3	ø8
4	4	ø10
5	5	ø16
6	6	ø22

### 2 Valve type

0	N.C.
1	N.O.
2	Double acting

Note) For valve type combinations, refer to variations on the next page.

### 3 Body type

S	Space saving connection
---	-------------------------

### 4 Applicable fitting size

Symbol	Fitting size	Body class					
		2	3	4	5	6	
07	2	○					
11	3		○				
13	4			○			
19	5				○		
25	6					○	

Note) Refer to page 814 for How to Order fitting parts. Select a tube with the same size as the valve side fitting.

### 5 Pilot port type

Nil	With LQ3 fitting	Connection tubing size 1/8" x 0.086" (3 x 2) <sup>Note)</sup>
M	With LQ3 fitting	Connection tubing size 4 x 3 <sup>Note)</sup>
R	Threaded	Rc1/8
N	Threaded	NPT1/8

Note) Refer to page 846 for details of the applicable tubing sizes.

### 6 Pilot port direction

Symbol	Direction
Nil	1
P2	2
P3	3
P4	4
P5	5
P6	6
P7	7
P8	8

### Pilot port piping direction

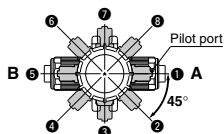

\* Specify the piping direction by part number when ordering the product. Do not change the pilot port direction. (Refer to Precautions on page 846.)

**7 Option 1**

<b>Nii</b>	None
<b>1</b>	With flow rate adjustment
<b>2</b>	With by-pass
<b>3</b>	With flow rate adjustment & by-pass
<b>4</b>	With indicator
<b>5</b>	High back pressure (0.42 MPa)
<b>6</b>	High back pressure with flow rate adjustment
<b>7</b>	High back pressure with by-pass
<b>8</b>	High back pressure with flow rate adjustment & by-pass
<b>9</b>	High back pressure with indicator
<b>24</b>	With indicator & by-pass









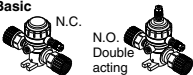
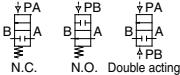

Note) Refer to variations in the table below for valve type and option 1 combinations. Options in the same table can not be combined each other.

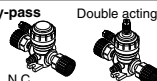
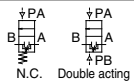
**8 Option 2**

Symbol	Applicable option										Note
	1	2	3	4	5	6	7	8	9	24	
<b>Nii</b>	○	○	○	○	○	○	○	○	○	○	—
<b>J</b>	○	—	—	—	—	—	—	—	—	—	For high temperature
<b>K</b>	○	○	○	○	○	○	○	○	○	○	Buffer material FFKM
<b>N</b>	○	○	○	○	○	○	○	○	○	○	For ammonium hydroxide
<b>P</b>	—	—	—	○	○	—	—	—	—	—	High flow type LVQ6□ only

Note 1) Options 2 in the same table cannot be combined each other.  
Note 2) High back pressure specifications (5 to 9) in Option 1 and high temperature specification (J) in Option 2 cannot be combined.

**Variations**

Type	Symbol	Model	LVQ20S	LVQ30S	LVQ40S	LVQ50S	LVQ60S	
			Orifice diameter	ø4	ø8	ø10	ø16	ø22
			Connection fitting size	2	3	4	5	6
<b>Basic</b> 		N.C.	○	○	○	○	○	
		N.O.	○	○	○	○	○	
		Double acting	○	○	○	○	○	
<b>With flow rate adjustment</b> 		N.C.	○	○	○	○	○	
<b>With by-pass</b> 		N.C.	○	○	○	○	○	
		Double acting	○	○	○	○	○	
<b>With flow rate adjustment &amp; by-pass</b> 		N.C.	○	○	○	○	○	
<b>With indicator</b> 		N.C.	○	○	○	○	○	
<b>High back pressure</b> 		N.C.	○	○	○	○	○	
<b>With indicator &amp; by-pass</b> 		N.C.	○	○	○	○	○	

LVQ
LVA
LVH
LVQ
LVP
LVW
LQ1
LQ3
LVN
LQHB
TL
TIL
TLM
TILM
TD
TID
TH
TIH

## How to Order Space Saving Fittings

**LQ3 E 6A - SN -**  

• **Packaging**

Symbol	Packaging
<b>Nil</b>	Clean packaging equivalent to Class M3.5
<b>1</b>	Standard packaging equivalent to Class M5.5

• **One of the nuts is not attached.**

• **Fitting type**

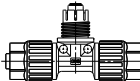
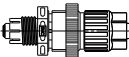
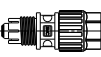
<b>E</b>	<b>T</b>
Union elbow 	Union tee 
<b>P</b>	<b>U</b>
Panel mount union 	Union 

• **Applicable tubing size** (Note 1) Note 2)

Size	Symbol	Applicable tubing size (mm)
<b>2</b>	<b>1</b>	6 x 4
<b>3</b>	<b>1</b>	10 x 8
<b>3</b>	<b>2</b>	8 x 6
<b>4</b>	<b>1</b>	12 x 10
<b>5</b>	<b>1</b>	19 x 16
<b>6</b>	<b>1</b>	25 x 22

Size	Symbol	Applicable tubing size (inch)
<b>2</b>	<b>A</b>	1/4" x 5/32"
<b>3</b>	<b>A</b>	3/8" x 1/4"
<b>4</b>	<b>A</b>	1/2" x 3/8"
<b>5</b>	<b>A</b>	3/4" x 5/8"
<b>6</b>	<b>A</b>	1" x 7/8"

Note 1) Select the same size as the fitting on the valve.

Note 2) Refer to page 846 for details of the applicable tubing sizes.

### Piping Example

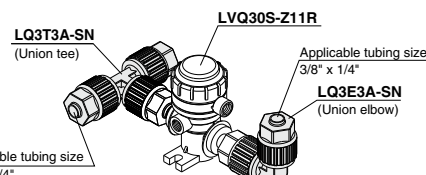

**LQ3T3A-SN**  
(Union tee)

**LQ3E3A-SN**  
(Union elbow)

Applicable tubing size  
3/8" x 1/4"

**LVQ30S-Z11R**

Applicable tubing size  
3/8" x 1/4"

**Ordering Example**

<b>LVQ30S-Z11R</b>	1
<b>LQ3T3A-SN</b> (Union tee)	1
<b>LQ3E3A-SN</b> (Union elbow)	1

Note) For shipment, the valve and fittings are individually packaged and dispatched together in 1 box.



### Standard Specifications



Model	LVQ20S	LVQ30S	LVQ40S	LVQ50S	LVQ60S	
Connection fitting size	2	3	4	5	6	
Orifice diameter	ø4	ø8	ø10	ø16	ø22	
Flow rate characteristics	Kv	0.3	1.1	1.6	4.2	6.8 (8.1) <sup>Note 1)</sup>
	Cv	0.35	1.3	1.9	5	8 (9.5) <sup>Note 1)</sup>
Withstand pressure (MPa)	1					
Operating pressure <A→B flow>	Standard	-98 kPa to 0.5 MPa <sup>Note 3)</sup>		-98 kPa to 0.4 MPa <sup>Note 3)</sup>		
	High temperature	-98 kPa to 0.3 MPa <sup>Note 3)</sup>				
Back pressure (MPa)	Standard	0.3 or less		0.2 or less		
	High back pressure	0.42 or less				
	High temperature	0.3 or less		0.2 or less		
Valve leakage (cm <sup>3</sup> /min)	0 (With water pressure)					
Pilot air pressure (MPa)	0.3 to 0.5 (High back pressure: 0.45 to 0.55)					
Pilot port size <sup>Note 2)</sup>	1/8" (ø3), ø4, Rc 1/8, NPT 1/8					
Fluid temperature (°C)	Standard	0 to 100				
	High temperature	0 to 170				
Ambient temperature (°C)	0 to 60					
Weight (kg)	0.085	0.175	0.223	0.725	0.835	

Note 1) ( ): High flow type

Note 2) Refer to page 846 for details of the applicable tubing sizes.

Note 3) This product cannot be used for vacuum retention. Also, connecting the vacuum to the B port may reduce the life of the product.

### ⚠ Specific Product Precautions

Be sure to read this before handling the products. Refer to back page 50 for Safety Instructions and pages 845 and 846 for Air Operated Chemical Liquid Valve Precautions.

#### Piping

### ⚠ Caution

1. Tighten the nut until it touches the end surface of the body, and then tighten it an additional 1/8 turn. If the nut won't turn any further, then it means a sufficient tightening has occurred. Refer to the proper tightening torques shown below.

#### Tightening Torque for Piping

Body class	Torque (N·m)
2	1.6 to 1.8
3	3.2 to 3.5
4	5.0 to 5.3
5	10.0 to 10.5
6	22.5 to 23.0

LVQ

LVA

LVH

LVD

LVQ

LVP

LVW

LQ1

LQ3

LVN

LQHB

TL

TIL

TLM

TILM

TD

TID

TH

TIH

# LVQS-Z Series

## Construction

### Basic

#### N.C.

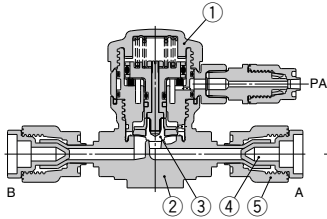

#### N.O.

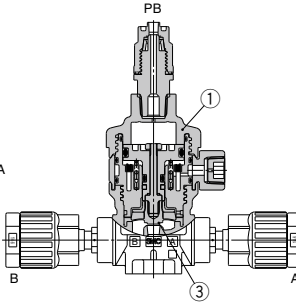

#### Double acting

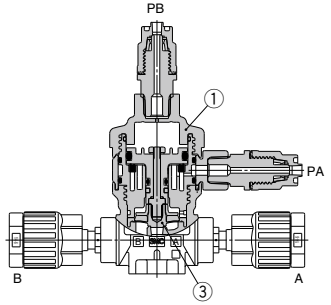

#### With flow rate adjustment

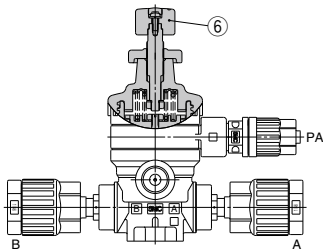

#### With by-pass

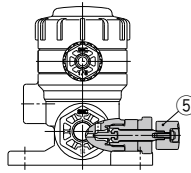

#### With indicator

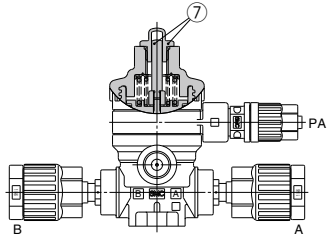

### Component Parts

No.	Description	Material
1	Actuator	PVDF
2	Body	PFA
3	Diaphragm	PTFE
4	Plug	PP
5	Nut	PFA
6	Flow rate adjuster	PVDF
7	Indicator/Cover	PP

## Dimensions

Basic, High back pressure

N.C. valve

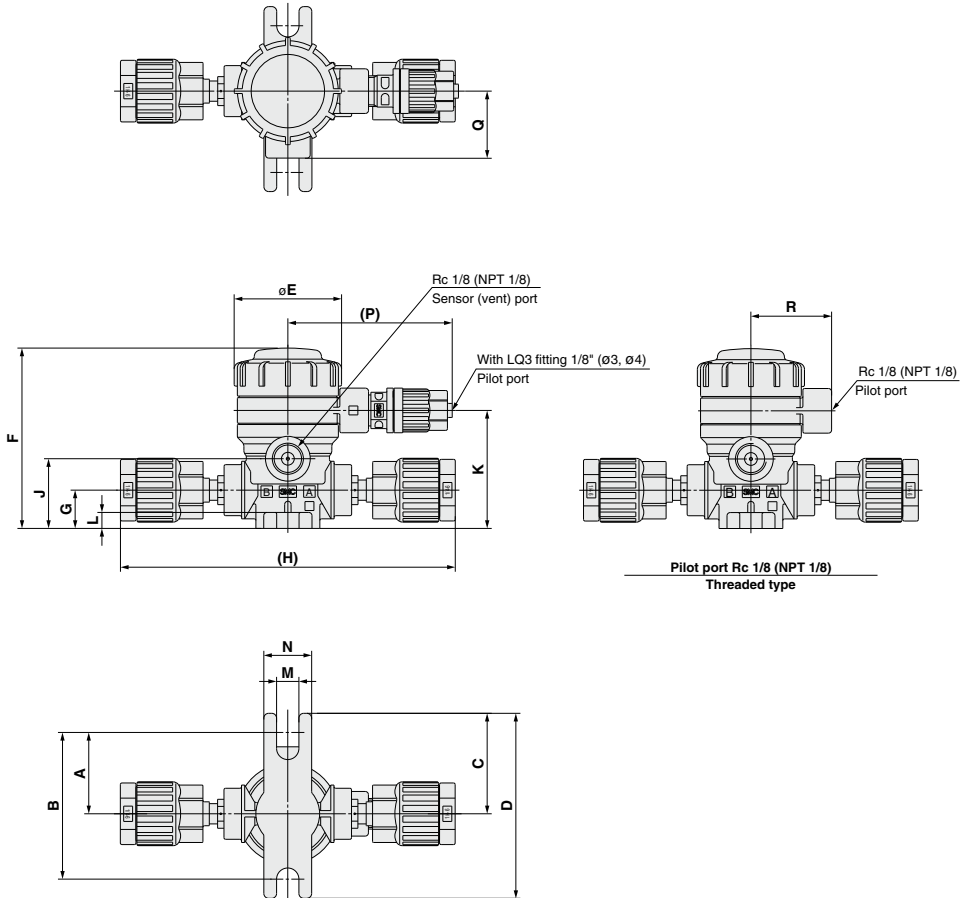

LVQ
LVA
LVH
LVD
<b>LVQ</b>
LVP
LVW
LQ1
LQ3
LVN
LQHB
TL
TIL
TLM
TILM
TD
TID
TH
TIH

LVQ□0S-Z□ Dimensions (N.C. Valve)

(mm)

Model	A	B	C	D	E	F	G	H	J	K	L	M	N	P	Q	R
LVQ20S-Z□	25.5	46	31.5	58	33.6	56.5	12	105	21.8	37	5	7	15	53.5	21	25.3
LVQ30S-Z□	28.5	57	34.5	69	45.4	77	16.5	137	32	50	6	7	20	59.5	25	31.2
LVQ40S-Z□	28.5	57	34.5	69	45.4	82.5	22	151	37.5	55.5	6	7	20	59.5	25	31.2
LVQ50S-Z□	42	84	48	96	75	127	25	202	50.2	78.2	10	7	20	73	38.5	45
LVQ60S-Z□	42	84	48	96	75	136.8	32	236	60	88	10	7	20	73	38.5	45

# LVQS-Z Series

## Dimensions

With flow rate adjustment, High back pressure with flow rate adjustment

N.C. valve

Dimensions (mm)	
Model	S
LVQ20S-Z□-1	83
LVQ30S-Z□-1	113.5
LVQ40S-Z□-1	119
LVQ50S-Z□-1	171.5
LVQ60S-Z□-1	182.5

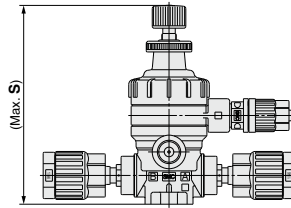

With by-pass, High back pressure with by-pass

N.C. valve

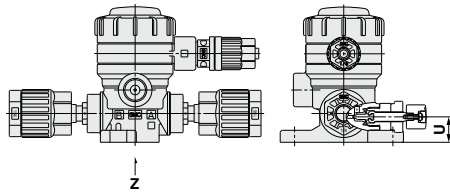
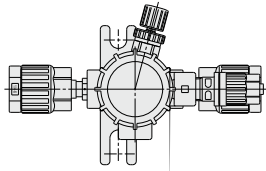

LVQ20S

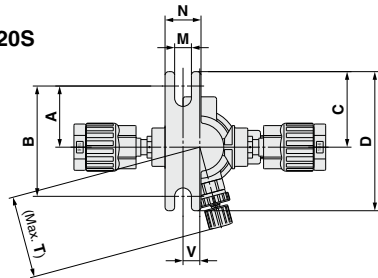

LVQ30S, LVQ40S  
LVQ50S, LVQ60S

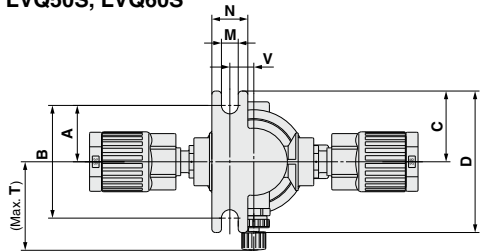

View Z

Dimensions (mm)									
Model	A	B	C	D	M	N	T	U	V
LVQ20S-Z□-2	25.5	46	31.5	58	7	15	34.3	10.6	7
LVQ30S-Z□-2	25.5	51	31.5	63	7	15	36.9	16.5	10
LVQ40S-Z□-2	25.5	51	31.5	63	7	15	37.9	22	10
LVQ50S-Z□-2	38	76	44	88	7	20	64	25	17
LVQ60S-Z□-2	38	76	44	88	7	20	66	32	17

With flow rate adjustment & by-pass,  
High back pressure with flow rate adjustment & by-pass  
N.C. valve

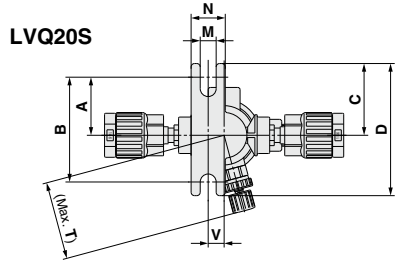
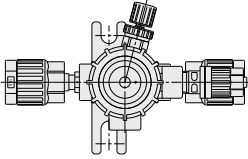

LVQ30S, LVQ40S  
LVQ50S, LVQ60S

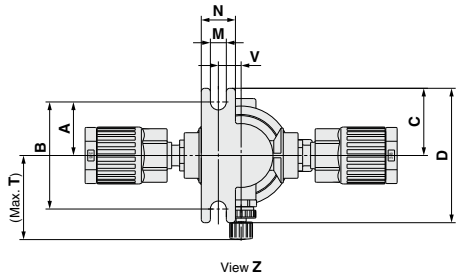
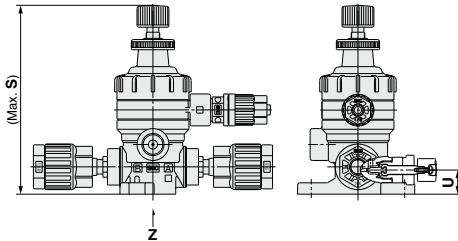

LVQ
LVA
LVH
LVD
<b>LVQ</b>
LVP
LVW
LQ1
LQ3
LVN
LQHB
TL
TIL
TLM
TILM
TD
TID
TH
TIH

**Dimensions** (mm)

Model	A	B	C	D	M	N	S	T	U	V
LVQ20S-Z□-3	25.5	46	31.5	58	7	15	83	34.3	10.6	7
LVQ30S-Z□-3	25.5	51	31.5	63	7	15	113.5	36.9	16.5	10
LVQ40S-Z□-3	25.5	51	31.5	63	7	15	119	37.9	22	10
LVQ50S-Z□-3	38	76	44	88	7	20	171.5	64	25	17
LVQ60S-Z□-3	38	76	44	88	7	20	182.5	66	32	17

With indicator, High back pressure with indicator  
N.C. valve

**Dimensions** (mm)

Model	S
LVQ20S-Z□-4	70.5
LVQ30S-Z□-4	88.5
LVQ40S-Z□-4	94
LVQ50S-Z□-4	134.5
LVQ60S-Z□-4	144

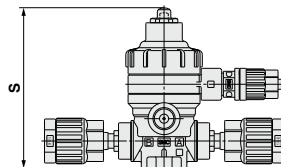

# LVQS-Z Series

## Dimensions

### Basic N.O. valve

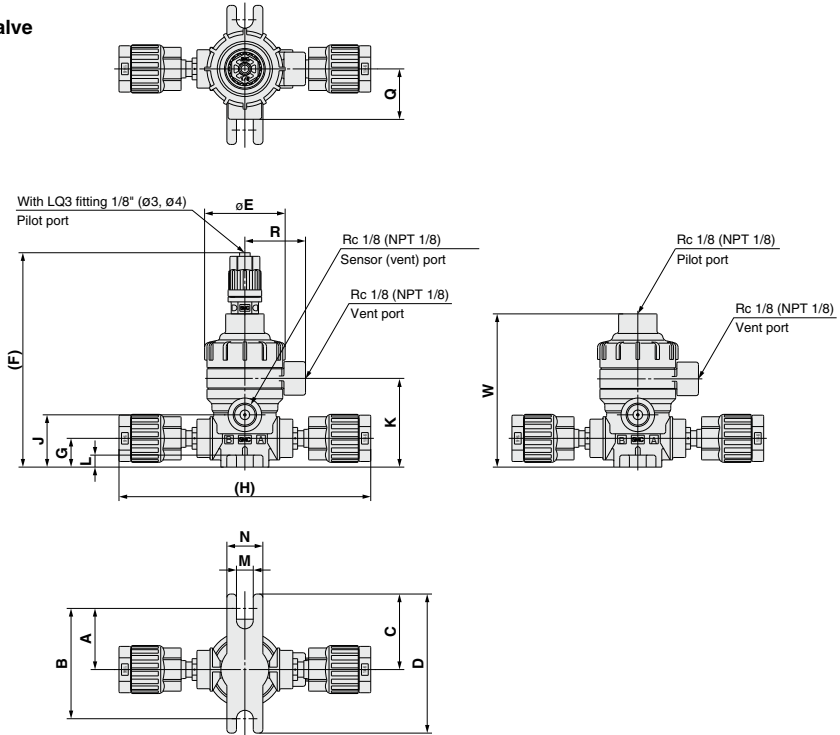

### Double acting valve

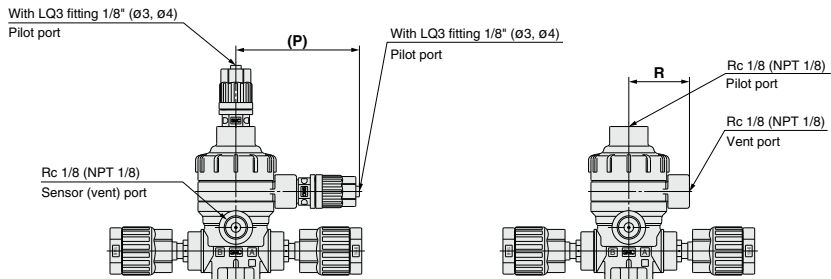

### LVQ□S-Z□ Dimensions (N.O. Valve, Double Acting Valve)

Model	A	B	C	D	E	F	G	H	J	K	L	M	N	P	Q	R	W
LVQ2:S-Z□	25.5	46	31.5	58	33.6	89.5	12	105	21.8	37	5	7	15	53.5	21	25.3	64
LVQ3:S-Z□	28.5	57	34.5	69	45.4	107.5	16.5	137	32	50	6	7	20	59.5	25	31.2	82
LVQ4:S-Z□	28.5	57	34.5	69	45.4	113	22	151	37.5	55.5	6	7	20	59.5	25	31.2	87.5
LVQ5:S-Z□	42	84	48	96	75	153.2	25	202	50.2	78.2	10	7	20	73	38.5	45	128
LVQ6:S-Z□	42	84	48	96	75	163	32	236	60	88	10	7	20	73	38.5	45	137.5

With by-pass  
Double acting valve

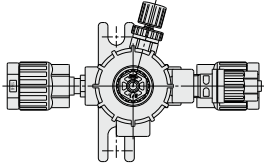

LVQ2<sup>1</sup>/<sub>2</sub>S

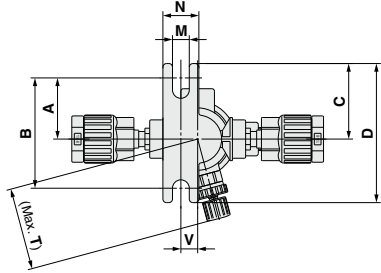

LVQ3<sup>1</sup>/<sub>2</sub>S, LVQ4<sup>1</sup>/<sub>2</sub>S  
LVQ5<sup>1</sup>/<sub>2</sub>S, LVQ6<sup>1</sup>/<sub>2</sub>S

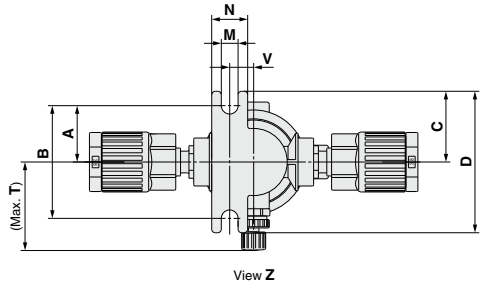
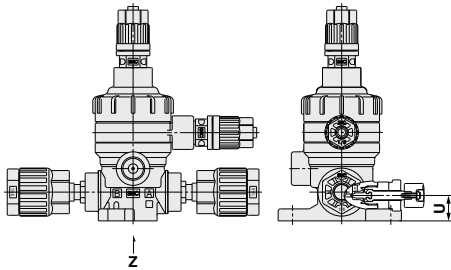

Dimensions (N.O Valve, Double Acting Valve) (mm)

Model	A	B	C	D	M	N	T	U	V
LVQ2:-S-Z-□-2	25.5	46	31.5	58	7	15	34.3	10.6	7
LVQ3:-S-Z-□-2	25.5	51	31.5	63	7	15	36.9	16.5	10
LVQ4:-S-Z-□-2	25.5	51	31.5	63	7	15	37.9	22	10
LVQ5:-S-Z-□-2	38	76	44	88	7	20	64	25	17
LVQ6:-S-Z-□-2	38	76	44	88	7	20	66	32	17

- LVQ
- LVA
- LVH
- LVQ
- LVP
- LVW
- LQ1
- LQ3
- LVN
- LQHB
- TL
- TIL
- TLM
- TILM
- TD
- TID
- TH
- TIH

# Manually Operated Flare, Integrated Fitting Type Hyper Fitting **LVQH-Z Series**



## How to Order

LVQH **2** 0 - Z **07**    - **1** -   

### Body class

Symbol	Body class	Orifice dia.
2	2	ø4
3	3	ø8
4	4	ø10
5	5	ø16
6	6	ø22

### Option

Symbol	Option
Nil	None
K	Buffer material FFKM
N	For ammonium hydroxide

Note) Options cannot be combined each other.

### LQ3 integrated fitting

### Applicable tubing size

Symbol	Connection tubing O.D.	Body class					
		2	3	4	5	6	
<b>Metric size</b>							
03	ø3	○					
04	ø4	○					
06	ø6	○					
08	ø8		○				
10	ø10		○				
12	ø12			○			
19	ø19					○	
25	ø25						○
<b>Inch size</b>							
03	1/8	○					
07	1/4	○					
11	3/8		○				
13	1/2			○			
19	3/4					○	
25	1						○

### Handle operation

1	90° turn type
4	Multi-turn type (With indicator)

### Vent port type

Nil	Threaded	NPT 1/8
R	Threaded	Rc1/8

## Variations

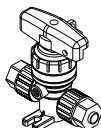
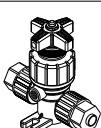
Type	Model	Orifice diameter					
		Tubing O.D.					
		LVQH20	LVQH30	LVQH40	LVQH50	LVQH60	
		ø4	ø8	ø10	ø16	ø22	
		Metric	6	10	12	19	25
		Inch	1/4	3/8	1/2	3/4	1
<b>90° turn type</b>			○	○	○	○	○
<b>Multi-turn type</b>			○	○	○	○	○



### Standard Specifications



Model		LVQH20	LVQH30	LVQH40	LVQH50	LVQH60
Tubing O.D.	Metric	6	10	12	19	25
	Inch	1/4	3/8	1/2	3/4	1
Orifice diameter		ø4	ø8	ø10	ø16	ø22
Flow rate characteristics	Kv	0.3	1.1	1.6	4.2	6.8
	Cv	0.35	1.3	1.9	5	8
Withstand pressure (MPa)		1				
Fluid pressure <A→B>		-98 kPa to 0.5 MPa <small>Note)</small>			-98 kPa to 0.4 MPa <small>Note)</small>	
Back pressure (MPa)		0.3 or less			0.2 or less	
Valve leakage (cm <sup>3</sup> /min)		0 (With water pressure)				
Fluid temperature (°C)		0 to 100				
Ambient temperature (°C)		0 to 60				
Weight (kg)	LVQH□0-1	0.12	0.27	0.32	1.14	1.20
	LVQH□0-4	0.11	0.25	0.23	0.72	0.82

Note) This product cannot be used for vacuum retention. Also, connecting the vacuum to the B port may reduce the life of the product.

### ⚠ Specific Product Precautions

Be sure to read this before handling the products. Refer to back page 50 for Safety Instructions and pages 845 and 846 for Air Operated Chemical Liquid Valve Precautions.

#### Piping

### ⚠ Caution

#### 1. Connect tubing by special tools.

For information on tubing fittings and special tools, please see the pamphlet "High Purity Fluoropolymer Fittings Hyper Fitting Flare Type LQ3 Series Fitting Procedure" (M-E06-4). (The pamphlet can be downloaded from the SMC home page.)

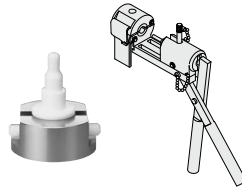

#### 2. Tighten the nut until it touches the end surface of the body, and then tighten it an additional 1/8 turn. If the nut won't turn any further, then it means a sufficient tightening has occurred. Refer to the proper tightening torques shown below.

#### Tightening Torque for Piping

Body class	Torque (N·m)
2	1.6 to 1.8
3	3.2 to 3.5
4	5.0 to 5.3
5	10.0 to 10.5
6	22.5 to 23.0

LVC

LVA

LVH

LVD

LVQ

LVP

LVW

LQ1

LQ3

LVN

LQHB

TL

TIL

TLM

TILM

TD

TID

TH

TIH

# LVQH-Z Series

## Construction

### 90° turn type

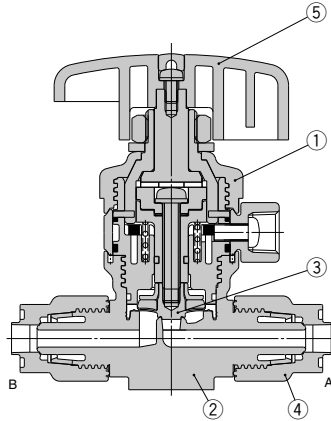

### Multi-turn type (With indicator)

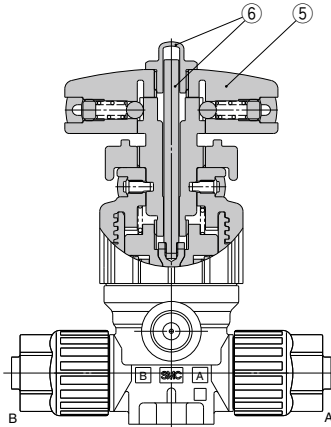

### Component Parts

No.	Description	Material
1	Actuator	PVDF
2	Body	PFA
3	Diaphragm	PTFE
4	Nut	PFA
5	Handle	PVDF
6	Indicator/Cover	PP

## Dimensions

### 90° turn type

#### Dimensions

Model	A	B	C	D	F	G	H
LVQH20-Z□□-1	25.5	46	31.5	58	79	12	75
LVQH30-Z□□-1	28.5	57	34.5	69	103	16.5	103
LVQH40-Z□□-1	28.5	57	34.5	69	108	22	114
LVQH50-Z□□-1	42	84	48	96	165	25	150
LVQH60-Z□□-1	42	84	48	96	175	32	167

Model	J	K	L	M	N	Q	Y
LVQH20-Z□□-1	21.8	37	5	7	15	21	55
LVQH30-Z□□-1	32	50	6	7	20	25	80
LVQH40-Z□□-1	37.5	55.5	6	7	20	25	80
LVQH50-Z□□-1	50.2	78.2	10	7	20	38.5	110
LVQH60-Z□□-1	60	88	10	7	20	38.5	110

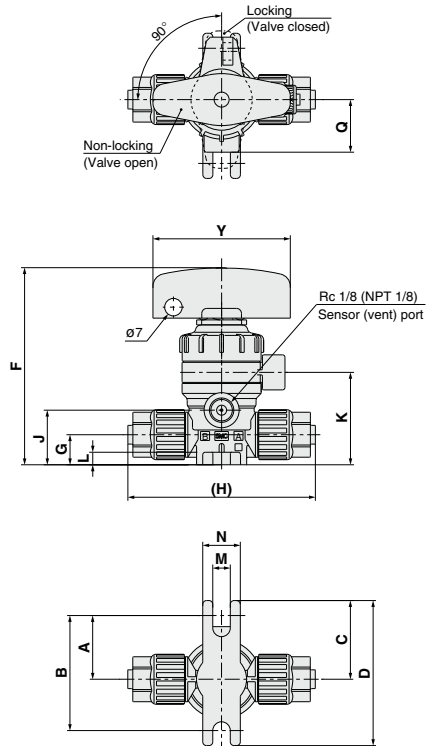

### Multi-turn type (With indicator)

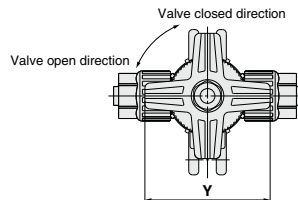

#### Dimensions

Model	S	Y
LVQH20-Z□-4	93.6	50
LVQH30-Z□-4	111.2	50
LVQH40-Z□-4	116.7	50
LVQH50-Z□-4	170.7	71
LVQH60-Z□-4	180.2	71

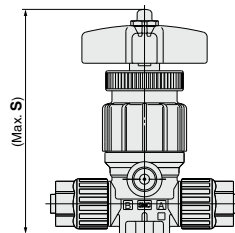

LVC  
LVA  
LVH  
LVD  
**LVQ**  
LVP  
LVW  
LQ1  
LQ3  
LVN  
LQHB  
TL  
TIL  
TLM  
TILM  
TD  
TID  
TH  
TIH

# Manually Operated Flare, Integrated Fitting Type Space Saving/Space Saving Connection **LVQHS-Z Series** RoHS

## How to Order

LVQH 2 0 S - Z 07   - 1 -  

### Body class

Symbol	Body class	Orifice dia.
2	2	ø4
3	3	ø8
4	4	ø10
5	5	ø16
6	6	ø22

### Body type

S	Space saving connection
---	-------------------------

LQ3 integrated fitting

### Option

Symbol	Option
Nil	None
K	Buffer material FFKM
N	For ammonium hydroxide

Note) Options cannot be combined each other.

### Handle operation

1	90° turn type
4	Multi-turn type (With indicator)

### Vent port type

Nil	Threaded	NPT 1/8
R	Threaded	Rc 1/8

### Applicable fitting size

Symbol	Fitting size	Body class				
		2	3	4	5	6
<b>Inch size</b>						
07	2	○				
11	3		○			
13	4			○		
19	5				○	
25	6					○

Note) Refer to page 827 for How to Order applicable fittings.  
Select the same size as fitting on the valve.

## Variations

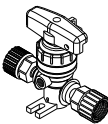
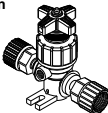
Model	LVQ20S	LVQ30S	LVQ40S	LVQ50S	LVQ60S	
						Orifice diameter
Type	Symbol	2	3	4	5	6
90° turn type		○	○	○	○	○
Multi-turn type		○	○	○	○	○

**How to Order Space Saving Fittings**

**LQ3 E 6A - SN -**  

• **Packaging**

Symbol	Packaging
<b>Nil</b>	Clean packaging equivalent to Class M3.5
<b>1</b>	Standard packaging equivalent to Class M5.5

• **One of the nuts is not attached.**

• **Fitting type**

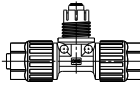
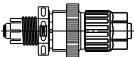
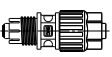
<b>E</b>	<b>T</b>
Union elbow 	Union tee 
<b>P</b>	<b>U</b>
Panel mount union 	Union 

• **Applicable tubing size** Note 1) Note 2)

Size	Symbol	Applicable tubing size (mm)
<b>2</b>	<b>1</b>	6 x 4
<b>3</b>	<b>1</b>	10 x 8
<b>3</b>	<b>2</b>	8 x 6
<b>4</b>	<b>1</b>	12 x 10
<b>5</b>	<b>1</b>	19 x 16
<b>6</b>	<b>1</b>	25 x 22

Size	Symbol	Applicable tubing size (inch)
<b>2</b>	<b>A</b>	1/4" x 5/32"
<b>3</b>	<b>A</b>	3/8" x 1/4"
<b>4</b>	<b>A</b>	1/2" x 3/8"
<b>5</b>	<b>A</b>	3/4" x 5/8"
<b>6</b>	<b>A</b>	1" x 7/8"

Note 1) Select the same size as the fitting on the valve.

Note 2) Refer to page 846 for details of the applicable tubing sizes.

**Piping Example**

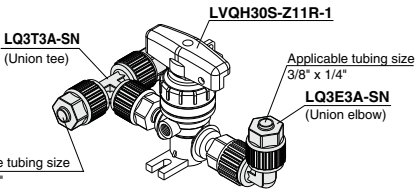

**Ordering Example**

<b>LVQH30S-Z11R-1</b>	1
<b>LQ3T3A-SN</b> (Union tee)	1
<b>LQ3E3A-SN</b> (Union elbow)	1

Note) For shipment, the valve and fittings are individually packaged and dispatched together in 1 box.

**LVC**

**LVA**

**LVH**

**LVD**

**LVQ**

**LVP**

**LVW**

**LQ1**

**LQ3**

**LVN**

**LQHB**

**TL**

**TIL**

**TLM**

**TILM**

**TD**

**TID**

**TH**

**TIH**



## Standard Specifications

Model	LVQH20S	LVQH30S	LVQH40S	LVQH50S	LVQH60S	
Connection fitting size	2	3	4	5	6	
Orifice diameter	ø4	ø8	ø10	ø16	ø22	
Flow rate characteristics	Kv	0.3	1.1	1.6	4.2	6.8
	Cv	0.35	1.3	1.9	5	8
Withstand pressure (MPa)	1					
Fluid pressure <A→B>	-98 kPa to 0.5 MPa <sup>Note)</sup>			-98 kPa to 0.4 MPa <sup>Note)</sup>		
Back pressure (MPa)	0.3 or less			0.2 or less		
Valve leakage (cm <sup>3</sup> /min)	0 (With water pressure)					
Fluid temperature (°C)	0 to 100					
Ambient temperature (°C)	0 to 60					
Weight (kg)	LVQH□0S-1	0.14	0.28	0.34	1.14	1.15
	LVQH□0S-4	0.13	0.21	0.25	0.72	0.86

Note) This product cannot be used for vacuum retention. Also, connecting the vacuum to the B port may reduce the life of the product.

## ⚠ Specific Product Precautions

Be sure to read this before handling the products. Refer to back page 50 for Safety Instructions and pages 845 and 846 for Air Operated Chemical Liquid Valve Precautions.

### Piping

## ⚠ Caution

1. Tighten the nut until it touches the end surface of the body, and then tighten it an additional 1/8 turn. If the nut won't turn any further, then it means a sufficient tightening has occurred. Refer to the proper tightening torques shown below.

#### Tightening Torque for Piping

Body class	Torque (N·m)
2	1.6 to 1.8
3	3.2 to 3.5
4	5.0 to 5.3
5	10.0 to 10.5
6	22.5 to 23.0

## Construction

### 90° turn type

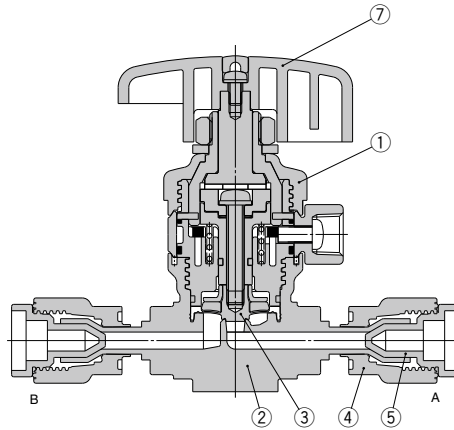

### Multi-turn type (With indicator)

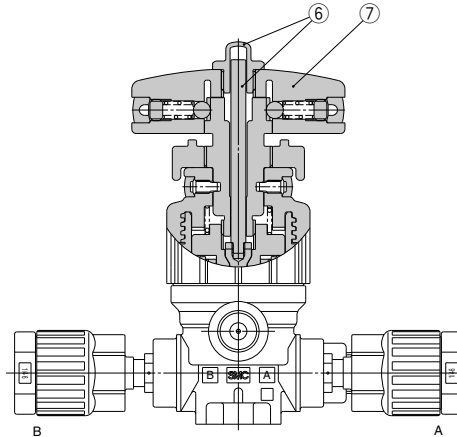

### Component Parts

No.	Description	Material
1	Actuator	PVDF
2	Body	PFA
3	Diaphragm	PTFE
4	Nut	PFA
5	Plug	PP
6	Indicator/Cover	PP
7	Handle	PVDF

LVC
LVA
LVH
LVD
<b>LVQ</b>
LVP
LVW
LQ1
LQ3
LVN
LQHB
TL
TIL
TLM
TILM
TD
TID
TH
TIH

# LVQHS-Z Series

## Dimensions

### 90° turn type

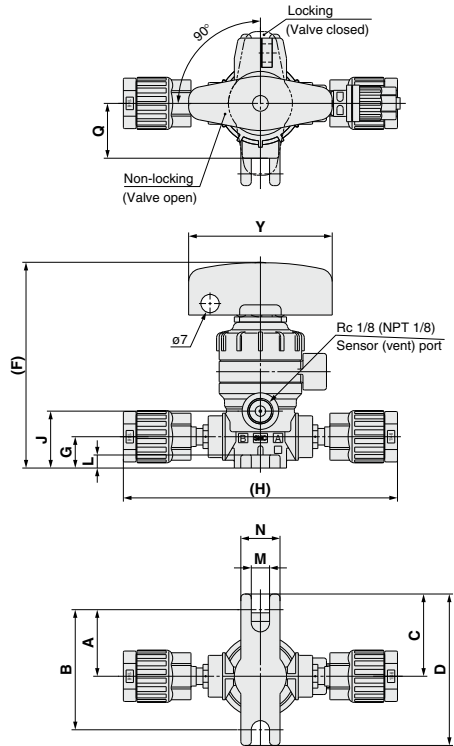

### Dimensions

Model	A	B	C	D	F	G	H
LVQH20S-Z□-1	25.5	46	31.5	58	79	12	105
LVQH30S-Z□-1	28.5	57	34.5	69	103	16.5	137
LVQH40S-Z□-1	28.5	57	34.5	69	108	22	151
LVQH50S-Z□-1	42	84	48	96	165	25	202
LVQH60S-Z□-1	42	84	48	96	175	32	236

Model	J	K	L	M	N	Q	Y
LVQH20S-Z□-1	21.8	37	5	7	15	21	55
LVQH30S-Z□-1	32	50	6	7	20	25	80
LVQH40S-Z□-1	37.5	55.5	6	7	20	25	80
LVQH50S-Z□-1	50.2	78.2	10	7	20	38.5	110
LVQH60S-Z□-1	60	88	10	7	20	38.5	110

### Multi-turn type (With indicator)

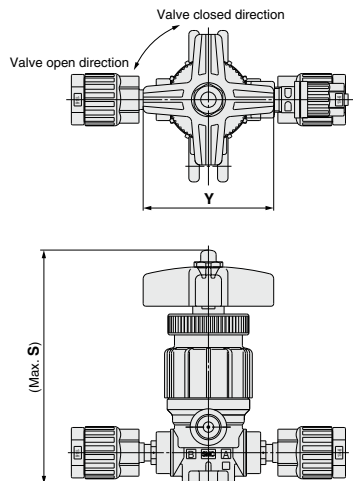

### Dimensions

Model	S	Y
LVQH20S-Z□-4	93.6	50
LVQH30S-Z□-4	111.2	50
LVQH40S-Z□-4	116.7	50
LVQH50S-Z□-4	170.7	71
LVQH60S-Z□-4	180.2	71



# Air Operated Tube Extension Type **LVQ-T Series**



## How to Order

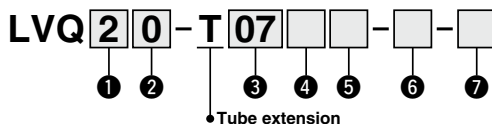

### 1 Body class

Symbol	Body class	Orifice dia.
2	2	ø4
3	3	ø8
4	4	ø10
5	5	ø16
6	6	ø22

### 4 Pilot port type

Nil	With LQ1 fitting	Connection tubing O.D. 1/8" (ø3)
M	With LQ1 fitting	Connection tubing O.D. ø4
R	Threaded	Rc1/8
N	Threaded	NPT1/8

### 2 Valve type

0	N.C.
1	N.O.
2	Double acting

Note) For valve type combinations, refer to variations on the next page.

### 5 Pilot port direction

Symbol	Direction
Nil	1
P2	2
P3	3
P4	4
P5	5
P6	6
P7	7
P8	8

#### Pilot port piping direction

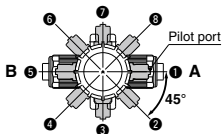

\* Specify the piping direction by part number when ordering the product. Do not change the pilot port direction. (Refer to Precautions on page 846.)

### 3 Applicable tubing size

Symbol	Connection tubing O.D.	Body class					
		2	3	4	5	6	
<b>Metric size</b>							
06	ø6	<input type="checkbox"/>	<input type="checkbox"/>	<input type="checkbox"/>	<input type="checkbox"/>	<input type="checkbox"/>	<input type="checkbox"/>
10	ø10	<input type="checkbox"/>	<input type="checkbox"/>	<input type="checkbox"/>	<input type="checkbox"/>	<input type="checkbox"/>	<input type="checkbox"/>
12	ø12	<input type="checkbox"/>	<input type="checkbox"/>	<input type="checkbox"/>	<input type="checkbox"/>	<input type="checkbox"/>	<input type="checkbox"/>
19	ø19	<input type="checkbox"/>	<input type="checkbox"/>	<input type="checkbox"/>	<input type="checkbox"/>	<input type="checkbox"/>	<input type="checkbox"/>
25	ø25	<input type="checkbox"/>	<input type="checkbox"/>	<input type="checkbox"/>	<input type="checkbox"/>	<input type="checkbox"/>	<input type="checkbox"/>
<b>Inch size</b>							
07	1/4	<input type="checkbox"/>	<input type="checkbox"/>	<input type="checkbox"/>	<input type="checkbox"/>	<input type="checkbox"/>	<input type="checkbox"/>
11	3/8	<input type="checkbox"/>	<input type="checkbox"/>	<input type="checkbox"/>	<input type="checkbox"/>	<input type="checkbox"/>	<input type="checkbox"/>
13	1/2	<input type="checkbox"/>	<input type="checkbox"/>	<input type="checkbox"/>	<input type="checkbox"/>	<input type="checkbox"/>	<input type="checkbox"/>
19	3/4	<input type="checkbox"/>	<input type="checkbox"/>	<input type="checkbox"/>	<input type="checkbox"/>	<input type="checkbox"/>	<input type="checkbox"/>
25	1	<input type="checkbox"/>	<input type="checkbox"/>	<input type="checkbox"/>	<input type="checkbox"/>	<input type="checkbox"/>	<input type="checkbox"/>

**6 Option 1**

<b>Nii</b>	None
<b>1</b>	With flow rate adjustment
<b>2</b>	With by-pass
<b>3</b>	With flow rate adjustment & by-pass
<b>4</b>	With indicator
<b>5</b>	High back pressure (0.42 MPa)
<b>6</b>	High back pressure with flow rate adjustment
<b>7</b>	High back pressure with by-pass
<b>8</b>	High back pressure with flow rate adjustment & by-pass
<b>9</b>	High back pressure with indicator











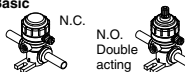



Note) Refer to variations in the table below for valve type and option 1 combinations. Options in the same table can not be combined each other.

**7 Option 2**

Symbol	Applicable option									Note
	1	2	3	4	5	6	7	8	9	
<b>Nii</b>	○	○	○	○	○	○	○	○	○	—
<b>J</b>	○	—	—	—	○	○	—	—	—	For high temperature
<b>K</b>	○	○	○	○	○	○	○	○	○	Buffer material FFKM
<b>N</b>	○	○	○	○	○	○	○	○	○	For ammonium hydroxide
<b>P</b>	—	—	—	○	○	—	—	—	—	High flow type <b>LVQ6</b> □ only

Note 1) Options 2 in the same table cannot be combined each other.  
Note 2) High back pressure specifications (5 to 9) in Option 1 and high temperature specification (J) in Option 2 cannot be combined.

**Variations**

Type	Symbol	Model	Orifice diameter				
			LVQ20	LVQ30	LVQ40	LVQ50	LVQ60
			Tubing O.D.				
			Valve type				
<b>Basic</b> 	 N.C.  N.O.  Double acting	N.C.	○	○	○	○	
		N.O.	○	○	○	○	
<b>With flow rate adjustment</b> 	 N.C.	N.C.	○	○	○	○	
<b>With by-pass</b> 	 N.C.  Double acting	N.C.	○	○	○	○	
		Double acting	○	○	○	○	
<b>With flow rate adjustment &amp; by-pass</b> 	 N.C.	N.C.	○	○	○	○	
<b>With indicator</b> 	 N.C.	N.C.	○	○	○	○	
<b>High back pressure</b> 	 N.C.	N.C.	○	○	○	○	

- LVQ
- LVQ
- LVH
- LVQ
- LVP
- LVW
- LQ1
- LQ3
- LVN
- LQHB
- TL
- TIL
- TLM
- TILM
- TD
- TID
- TH
- TIH

# LVQ-T Series



## Standard Specifications

Model		LVQ20	LVQ30	LVQ40	LVQ50	LVQ60
Tubing O.D.	Metric	6	10	12	19	25
	Inch	1/4	3/8	1/2	3/4	1
Orifice diameter		ø4	ø8	ø10	ø16	ø22
Flow rate characteristics	Kv	0.3	1.1	1.6	4.2	6.8 (8.1) <sup>Note 1)</sup>
	Cv	0.35	1.3	1.9	5	8 (9.5) <sup>Note 1)</sup>
Withstand pressure (MPa)		1				
Operating pressure <A→B flow>	Standard	-98 kPa to 0.5 MPa <sup>Note 2)</sup>			-98 kPa to 0.4 MPa <sup>Note 2)</sup>	
	High temperature	-98 kPa to 0.3 MPa <sup>Note 2)</sup>				
Back pressure (MPa)	Standard	0.3 or less			0.2 or less	
	High back pressure	0.42 or less				
	High temperature	0.3 or less			0.2 or less	
Valve leakage (cm <sup>3</sup> /min)		0 (With water pressure)				
Pilot air pressure (MPa)		0.3 to 0.5 (High back pressure: 0.45 to 0.55)				
Pilot port size		1/8" (ø3), ø4, Rc 1/8, NPT 1/8				
Fluid temperature (°C)	Standard	0 to 100				
	High temperature	0 to 170				
Ambient temperature (°C)		0 to 60				
Weight (kg)		0.08	0.15	0.16	0.60	0.70

Note 1) ( ) : High flow type

Note 2) This product cannot be used for vacuum retention. Also, connecting the vacuum to the B port may reduce the life of the product.

## Construction

Basic  
N.C.

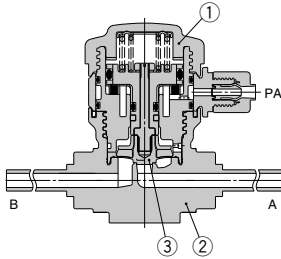

N.O.

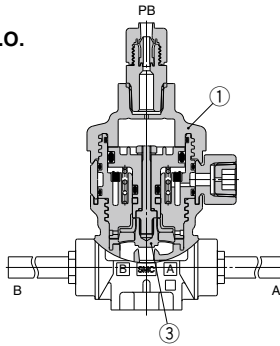

Double acting

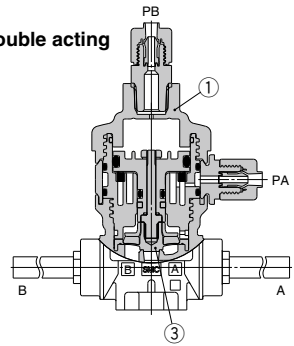

With flow rate adjustment

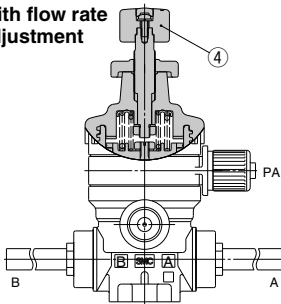

With by-pass

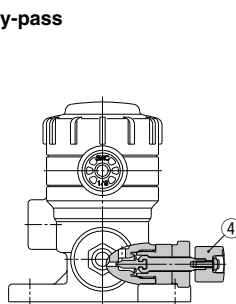

With indicator

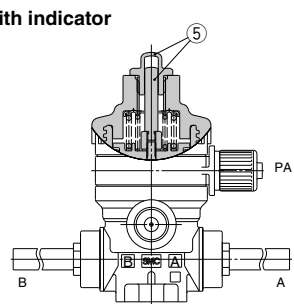

### Component Parts

No.	Description	Material
1	Actuator	PVDF
2	Body	PFA
3	Diaphragm	PTFE
4	Flow rate adjuster	PVDF
5	Indicator/Cover	PP

## Dimensions

Basic, High back pressure  
N.C. valve

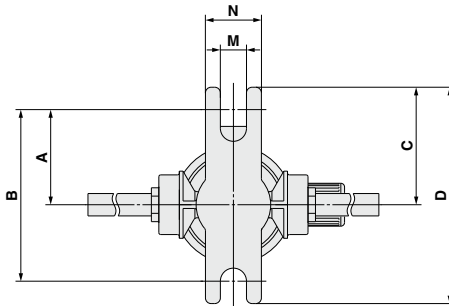
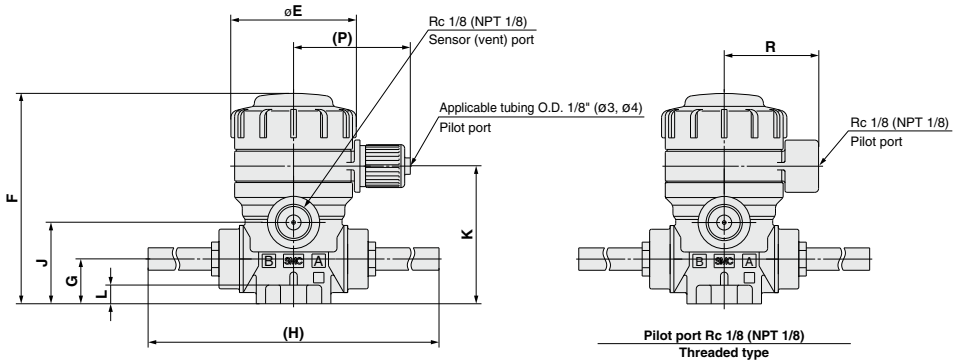
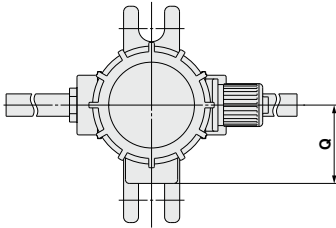

LVQ□0-T□ Dimensions (N.C. Valve)

(mm)

Model	A	B	C	D	E	F	G	H	J	K	L	M	N	P	Q	R
LVQ20-T□	25.5	46	31.5	58	33.6	56.5	12	111.5	21.8	37	5	7	15	31.3	21	25.3
LVQ30-T□	28.5	57	34.5	69	45.4	77	16.5	136	32	50	6	7	20	37.2	25	31.2
LVQ40-T□	28.5	57	34.5	69	45.4	82.5	22	137	37.5	55.5	6	7	20	37.2	25	31.2
LVQ50-T□	42	84	48	96	75	127	25	180	50.2	78.2	10	7	20	50.8	38.5	45
LVQ60-T□	42	84	48	96	75	137	32	189	60	88	10	7	20	50.8	38.5	45

LVC
LVA
LVH
LVD
<b>LVQ</b>
LVP
LVW
LQ1
LQ3
LVN
LQHB
TL
TIL
TLM
TILM
TD
TID
TH
TIH

# LVQ-T Series

## Dimensions

With flow rate adjustment, High back pressure with flow rate adjustment

N.C. valve

### Dimensions (mm)

Model	S
LVQ20-T□-1	83
LVQ30-T□-1	113.5
LVQ40-T□-1	119
LVQ50-T□-1	171.5
LVQ60-T□-1	182.5

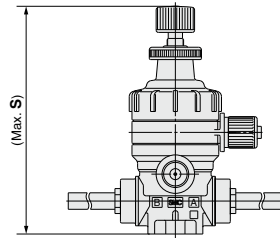

With by-pass, High back pressure with by-pass

N.C. valve

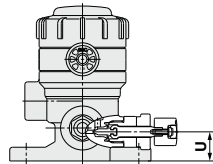
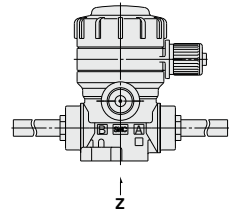
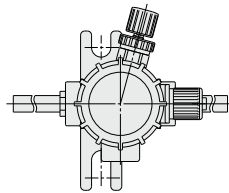

### LVQ20

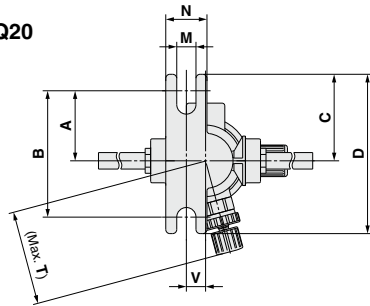

### LVQ30, LVQ40 LVQ50, LVQ60

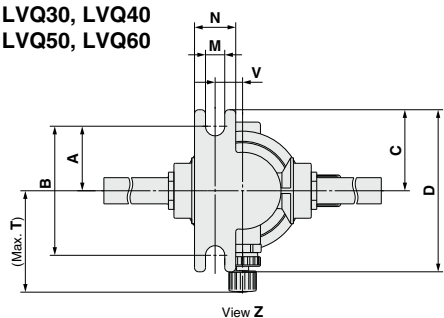

### Dimensions

(mm)

Model	A	B	C	D	M	N	T	U	V
LVQ20-T□-2	25.5	46	31.5	58	7	15	34.3	10.6	7
LVQ30-T□-2	25.5	51	31.5	63	7	15	36.9	16.5	10
LVQ40-T□-2	25.5	51	31.5	63	7	15	37.9	22	10
LVQ50-T□-2	38	76	44	88	7	20	64	25	17
LVQ60-T□-2	38	76	44	88	7	20	66	32	17

With flow rate adjustment & by-pass,  
High back pressure with flow rate adjustment & by-pass  
N.C. valve

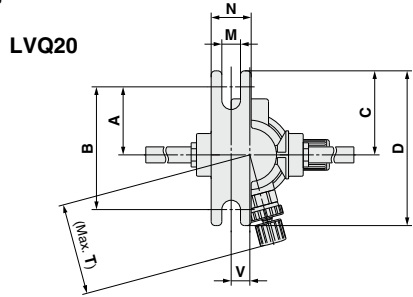
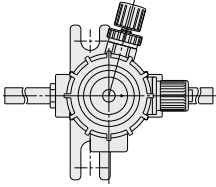

LVQ20

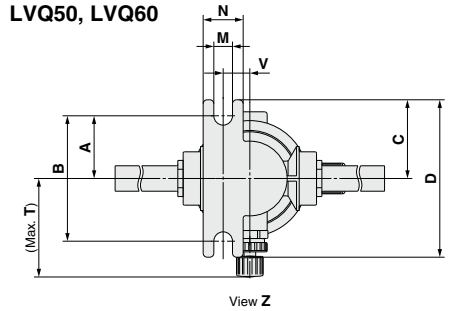
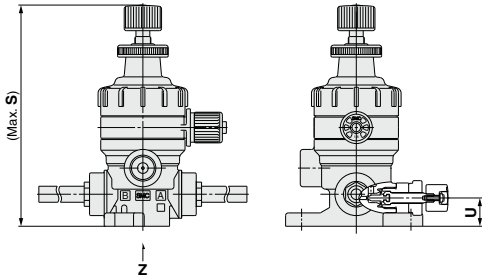

LVQ30, LVQ40  
LVQ50, LVQ60

- LVQ
- LVA
- LVH
- LVD
- LVQ**
- LVP
- LVW
- LQ1
- LQ3
- LVN
- LQHB
- TL
- TIL
- TLM
- TILM
- TD
- TID
- TH
- TIH

**Dimensions** (mm)

Model	A	B	C	D	M	N	S	T	U	V
LVQ20-T□-3	25.5	46	31.5	58	7	15	83	34.3	10.6	7
LVQ30-T□-3	25.5	51	31.5	63	7	15	113.5	36.9	16.5	10
LVQ40-T□-3	25.5	51	31.5	63	7	15	119	37.9	22	10
LVQ50-T□-3	38	76	44	88	7	20	171.5	64	25	17
LVQ60-T□-3	38	76	44	88	7	20	182.5	66	32	17

With indicator, High back pressure with indicator  
N.C. valve

**Dimensions** (mm)

Model	S
LVQ20-T□-4	70.5
LVQ30-T□-4	88.5
LVQ40-T□-4	94
LVQ50-T□-4	134.5
LVQ60-T□-4	144

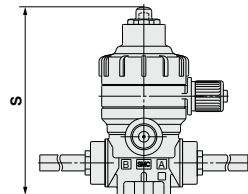

# LVQ-T Series

## Dimensions

### Basic N.O. valve

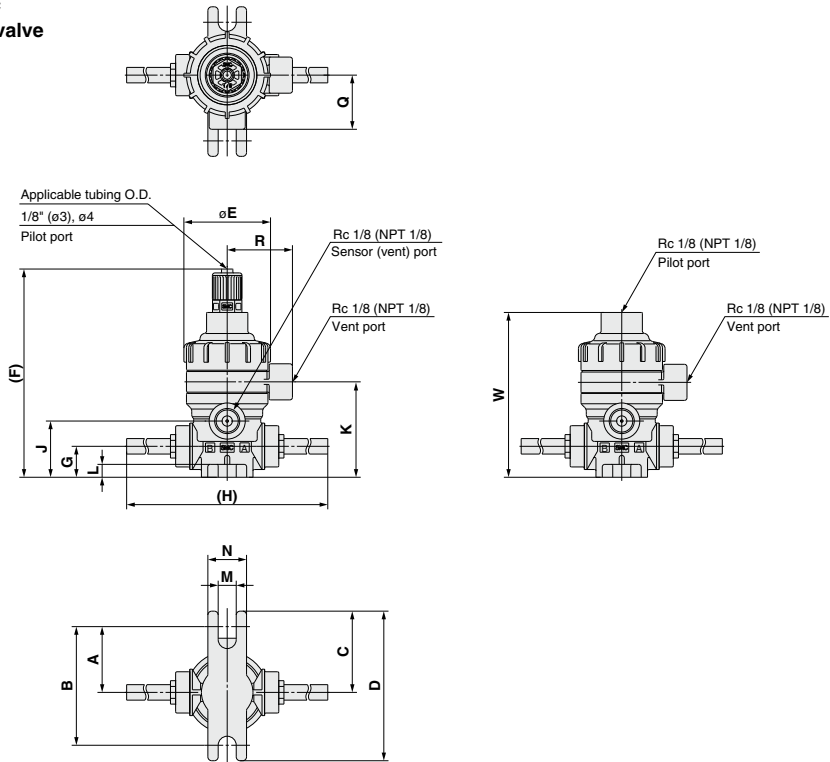

### Double acting valve

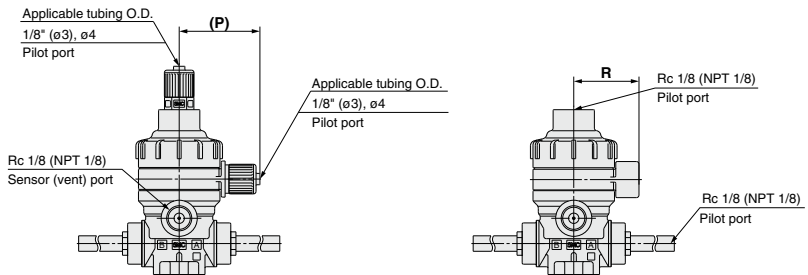

### LVQ□<sub>2</sub>-T□ Dimensions (N.O. Valve, Double Acting Valve)

(mm)

Model	A	B	C	D	E	F	G	H	J	K	L	M	N	P	Q	R	W
LVQ2 <sub>2</sub> -T□	25.5	46	31.5	58	33.6	81	12	111.5	21.8	37	5	7	15	31.3	21	25.3	64
LVQ3 <sub>2</sub> -T□	28.5	57	34.5	69	45.4	99	16.5	136	32	50	6	7	20	37.2	25	31.2	82
LVQ4 <sub>2</sub> -T□	28.5	57	34.5	69	45.4	104	22	137	37.5	55.5	6	7	20	37.2	25	31.2	87.5
LVQ5 <sub>2</sub> -T□	42	84	48	96	75	144.5	25	180	50.2	78.2	10	7	20	50.8	38.5	45	128
LVQ6 <sub>2</sub> -T□	42	84	48	96	75	154.5	32	189	60	88	10	7	20	50.8	38.5	45	137.5

With by-pass  
Double acting valve

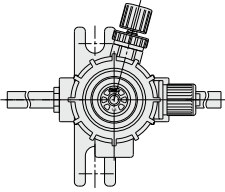

LVQ2<sup>1</sup><sub>2</sub>

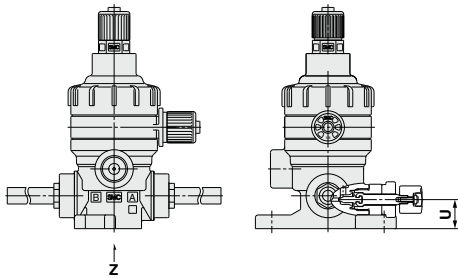
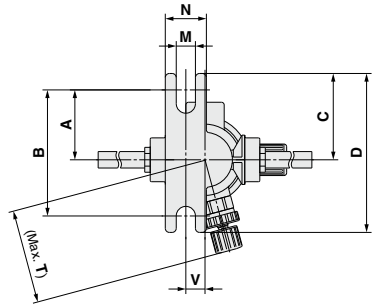

LVQ3<sup>1</sup><sub>2</sub>, LVQ4<sup>1</sup><sub>2</sub>  
LVQ5<sup>1</sup><sub>2</sub>, LVQ6<sup>1</sup><sub>2</sub>

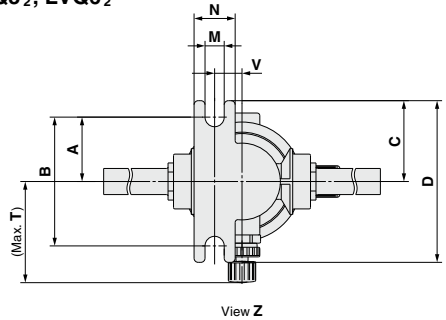

**Dimensions** (mm)

Model	A	B	C	D	M	N	T	U	V
LVQ2 <sup>1</sup> -T□-2	25.5	46	31.5	58	7	15	34.3	10.6	7
LVQ3 <sup>1</sup> -T□-2	25.5	51	31.5	63	7	15	36.9	16.5	10
LVQ4 <sup>1</sup> -T□-2	25.5	51	31.5	63	7	15	37.9	22	10
LVQ5 <sup>1</sup> -T□-2	38	76	44	88	7	20	64	25	17
LVQ6 <sup>1</sup> -T□-2	38	76	44	88	7	20	64	32	17

- LVC
- LVA
- LVH
- LVD
- LVQ**
- LVP
- LVW
- LQ1
- LQ3
- LVN
- LQHB
- TL
- TIL
- TLM
- TILM
- TD
- TID
- TH
- TIH



# Manually Operated Tube Extension Type

# LVQH-T Series

RoHS

## How to Order

LVQH **2** 0 - T 07 **1** - **1** - **1**

### Body class

Symbol	Body class	Orifice dia.
2	2	ø4
3	3	ø8
4	4	ø10
5	5	ø16
6	6	ø22

### Tube extension

### Applicable tubing size

Symbol	Connection tubing O.D.	Body class				
		2	3	4	5	6
<b>Metric size</b>						
06	ø6	○				
10	ø10		○			
12	ø12			○		
19	ø19				○	
25	ø25					○
<b>Inch size</b>						
07	1/4	○				
11	3/8		○			
13	1/2			○		
19	3/4				○	
25	1					○

### Option

Symbol	Option
Nil	None
K	Buffer material FFKM
N	For ammonium hydroxide

Note) Options cannot be combined each other.

### Handle operation

1	90° turn type
4	Multi-turn type (With indicator)

### Vent port type

Nil	Threaded	NPT 1/8
R	Threaded	Rc 1/8

## Variations

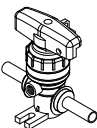
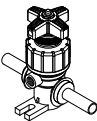
Type	Symbol	Model				
		Orifice diameter				
		LVQH20-T	LVQH30-T	LVQH40-T	LVQH50-T	LVQH60-T
		Tubing O.D.				
		Metric				
		Inch				
		1/4	3/8	1/2	3/4	1
90° turn type		○	○	○	○	○
Multi-turn type		○	○	○	○	○

### Standard Specifications



Model		LVQH20	LVQH30	LVQH40	LVQH50	LVQH60
Tubing O.D.	Metric	6	10	12	19	25
	Inch	1/4	3/8	1/2	3/4	1
Orifice diameter		ø4	ø8	ø10	ø16	ø22
Flow rate characteristics	Kv	0.3	1.1	1.6	4.2	6.8
	Cv	0.35	1.3	1.9	5	8
Withstand pressure (MPa)		1				
Fluid pressure <A→B>		-98 kPa to 0.5 MPa <sup>Note)</sup>			-98 kPa to 0.4 MPa <sup>Note)</sup>	
Back pressure (MPa)		0.3 or less			0.2 or less	
Valve leakage (cm <sup>3</sup> /min)		0 (With water pressure)				
Fluid temperature (°C)		0 to 100				
Ambient temperature (°C)		0 to 60				
Weight (kg)	LVQH□0-1	0.12	0.25	0.28	1.04	1.05
	LVQH□0-4	0.11	0.18	0.19	0.62	0.73

Note) This product cannot be used for vacuum retention. Also, connecting the vacuum to the B port may reduce the life of the product.

### Construction

#### 90° turn type

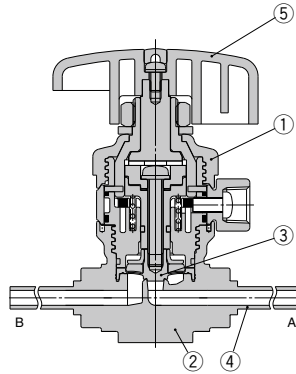

#### Multi-turn type (With indicator)

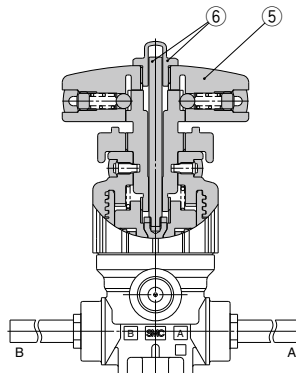

#### Component Parts

No.	Description	Material
1	Actuator	PVDF
2	Body	PFA
3	Diaphragm	PTFE
4	Insert bushing	PFA
5	Handle	PVDF
6	Indicator/Cover	PP

LV  
LVA  
LVH  
LVD  
LVQ  
LVP  
LVW  
LQ1  
LQ3  
LVN  
LQHB  
TL  
TIL  
TLM  
TILM  
TD  
TID  
TH  
TIH

# LVQH-T Series

## Dimensions

### 90° turn type

#### Dimensions

Model	A	B	C	D	F	G	H
LVQH20-T□-1	25.5	46	31.5	58	79	12	111.5
LVQH30-T□-1	28.5	57	34.5	69	103	16.5	136
LVQH40-T□-1	28.5	57	34.5	69	108	22	137
LVQH50-T□-1	42	84	48	96	165	25	180
LVQH60-T□-1	42	84	48	96	175	32	189

Model	J	K	L	M	N	Q	Y
LVQH20-T□-1	21.8	37	5	7	15	21	55
LVQH30-T□-1	32	50	6	7	20	25	80
LVQH40-T□-1	37.5	55.5	6	7	20	25	80
LVQH50-T□-1	50.2	78.2	10	7	20	38.5	110
LVQH60-T□-1	60	88	10	7	20	38.5	110

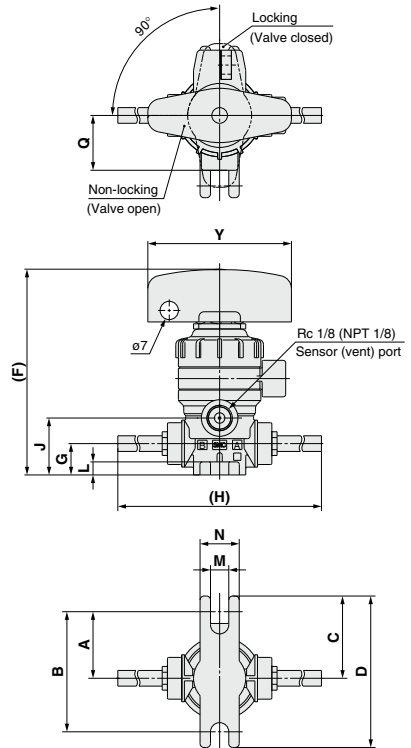

### Multi-turn type (With indicator)

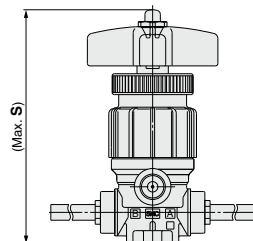
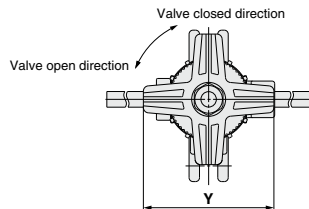

#### Dimensions

Model	S	Y
LVQH20-T□-4	93.6	50
LVQH30-T□-4	111.2	50
LVQH40-T□-4	116.7	50
LVQH50-T□-4	170.7	71
LVQH60-T□-4	180.2	71

# Air Operated, 0.5 MPa Back Pressure Tolerant Insert Bushing, Integrated Fitting Type Hyper Fitting

## LVQ□□H Series

RoHS

### How to Order

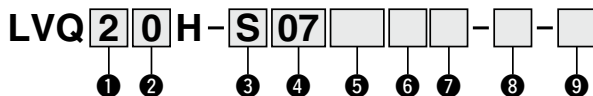

#### 1 Body class

Symbol	Body class	Orifice dia.
2	2	ø4
3	3	ø8
4	4	ø10
5	5	ø16
6	6	ø22

#### 2 Valve type

0	N.C.
1	N.O.
2	Double acting

Note) For valve type combinations, refer to variations on the next page.

#### 3 Fitting type

Symbol	Fitting type	Body class
V	LQ1	2, 3, 4, 5, 6
S	LQ2	2, 3, 4, 5

Note) Insert bushing is used in common.

#### 4 Applicable tubing size<sup>Note)</sup>

Symbol	Connection tubing size	Body class					
		2	3	4	5	6	
<b>Metric size</b>							
03	3 x 2	●					
04	4 x 3	●					
06	6 x 4	○	●				
08	8 x 6		●				
10	10 x 8			○	●		
12	12 x 10				○	●	
19	19 x 16					○	
25	25 x 22					○	
<b>Inch size</b>							
03	1/8" x 0.086"	●					
05	3/16" x 1/8"	●					
07	1/4" x 5/32"	○	●				
11	3/8" x 1/4"		○	●			
13	1/2" x 3/8"			○	●		
19	3/4" x 5/8"					○	
25	1" x 7/8"					○	

○ Basic size ● With reducer

Note) Refer to page 846 for details of the applicable tubing sizes.

#### 5 Port B (OUT) different dia. size

Symbol	Application
Nii	Ports A & B same size

Refer to the applicable tubing size table to the left.

Different diameter tubings can be selected within the same body class.

#### 6 Pilot port type

Nii	LQ1 integrated fitting	Connection tubing O.D. 1/8" (ø3)
M	LQ1 integrated fitting	Connection tubing O.D. ø4
R	Threaded	Rc1/8
N	Threaded	NPT1/8

#### 7 Pilot port direction

Symbol	Direction
Nii	1
P2	2
P3	3
P4	4
P5	5
P6	6
P7	7
P8	8

#### Pilot port piping direction

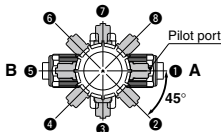

\* Specify the piping direction by part number when ordering the product. Do not change the pilot port direction. (Refer to Precautions on page 846.)

# Air Operated, 0.5 MPa Back Pressure Tolerant Insert Bushing, Integrated Fitting Type **LVQ□□H Series**

## 8 Option 1

<b>Nii</b>	None
<b>1</b>	With flow rate adjustment
<b>2</b>	With by-pass
<b>3</b>	With flow rate adjustment & by-pass
<b>4</b>	With indicator
<b>24</b>	With indicator & by-pass







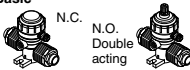
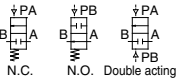

Note) Refer to variations in the table below for valve type and option 1 combinations. Options in the same table cannot be combined each other.

## 9 Option 2

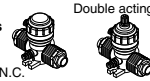
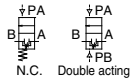
Symbol	Applicable option					Note
	1	2	3	4	24	
<b>Nii</b>	○	○	○	○	○	—
<b>K</b>	○	○	○	○	○	Buffer material FFKM
<b>N</b>	○	○	○	○	○	For ammonium hydroxide
<b>P</b>	—	—	—	○	—	High flow type LVQ6□ only

Note) Options 2 in the same table cannot be combined each other.

## Variations

Type	Symbol	Valve type	Model					
			LVQ20H	LVQ30H	LVQ40H	LVQ50H	LVQ60H	
			Orifice diameter					
		Tubing O.D.		LVQ20H	LVQ30H	LVQ40H	LVQ50H	LVQ60H
		Metric		ø4	ø8	ø10	ø16	ø22
		Inch		6	10	12	19	25
		1/4		3/8	1/2	3/4	1	
<b>Basic</b> 		N.C.	○	○	○	○	○	
		Double acting	○	○	○	○	○	
<b>With flow rate adjustment</b> 		N.C.	○	○	○	○		
<b>With by-pass</b> 		N.C.	○	○	○	○		
		Double acting	○	○	○	○		
<b>With flow rate adjustment &amp; by-pass</b> 		N.C.	○	○	○	○		
<b>With indicator</b> 		N.C.	○	○	○	○		
<b>With indicator &amp; by-pass</b> 		N.C.	○	○	○	○		

- LVQ
- LVA
- LVH
- LVQ
- LVP
- LVW
- LQ1
- LQ3
- LVN
- LQHB
- TL
- TIL
- TLM
- TILM
- TD
- TID
- TH
- TIH

# Air Operated, 0.5 MPa Back Pressure Tolerant Flare, Integrated Fitting Type Hyper Fitting

# LVQ□□H-Z Series

RoHS

## How to Order

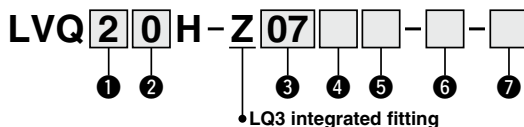

### 1 Body class

Symbol	Body class	Orifice dia.
2	2	ø4
3	3	ø8
4	4	ø10
5	5	ø16
6	6	ø22

### 4 Pilot port type

Symbol	With LQ3 fitting	Connection tubing size
Nll	With LQ3 fitting	1/8" x 0.086" (3 x 2) <sup>(Note)</sup>
M	With LQ3 fitting	Connection tubing size 4 x 3 <sup>(Note)</sup>
R	Threaded	Rc1/8
N	Threaded	NPT1/8

Note) Refer to page 846 for details of the applicable tubing sizes.

### 2 Valve type

0	N.C.
1	N.O.
2	Double acting

Note) For valve type combinations, refer to variations on the next page.

### 5 Pilot port direction

Symbol	Direction
Nll	1
P2	2
P3	3
P4	4
P5	5
P6	6
P7	7
P8	8

### Pilot port piping direction

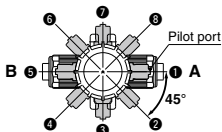

\* Specify the piping direction by part number when ordering the product. Do not change the pilot port direction. (Refer to Precautions on page 846.)

### 3 Applicable tubing size<sup>(Note)</sup>

Symbol	Connection tubing size	Body class					
		2	3	4	5	6	
<b>Metric size</b>							
03	3 x 2	○					
04	4 x 3	○					
06	6 x 4	○					
08	8 x 6		○				
10	10 x 8		○				
12	12 x 10			○			
19	19 x 16				○		
25	25 x 22					○	
<b>Inch size</b>							
07	1/4" x 5/32"	○					
11	3/8" x 1/4"		○				
13	1/2" x 3/8"			○			
19	3/4" x 5/8"				○		
25	1" x 7/8"					○	

Note) Refer to page 846 for details of the applicable tubing sizes.

# Air Operated, 0.5 MPa Back Pressure Tolerant Insert Bushing, Integrated Fitting Type **LVQ**□□**H-Z Series**

## 6 Option 1

<b>Nii</b>	None
<b>1</b>	With flow rate adjustment
<b>2</b>	With by-pass
<b>3</b>	With flow rate adjustment & by-pass
<b>4</b>	With indicator
<b>24</b>	With indicator & by-pass







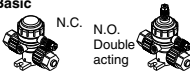
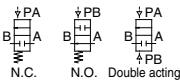

Note) Refer to variations in the table below for valve type and option 1 combinations. Options in the same table cannot be combined each other.

## 7 Option 2

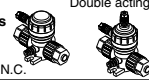
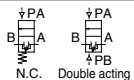
Symbol	Applicable option					Note
	1	2	3	4	24	
<b>Nii</b>	○	○	○	○	○	—
<b>K</b>	○	○	○	○	○	Buffer material FFKM
<b>N</b>	○	○	○	○	○	For ammonium hydroxide
<b>P</b>	—	—	—	○	—	High flow type LVQ6□ only

Note) Options 2 in the same table cannot be combined each other.

## Variations

Type	Symbol	Valve type	Model					
			Orifice diameter					
			Tubing O.D.					
			Inch					
			<b>LVQ20H</b>	<b>LVQ30H</b>	<b>LVQ40H</b>	<b>LVQ50H</b>	<b>LVQ60H</b>	
			ø4	ø8	ø10	ø16	ø22	
			Metric	6	10	12	19	25
			Inch	1/4	3/8	1/2	3/4	1
<b>Basic</b> 		N.C. N.O. Double acting	○	○	○	○	○	
<b>With flow rate adjustment</b> 		N.C.	○	○	○	○	○	
<b>With by-pass</b> 		N.C. Double acting	○	○	○	○	○	
<b>With flow rate adjustment &amp; by-pass</b> 		N.C.	○	○	○	○	○	
<b>With indicator</b> 		N.C.	○	○	○	○	○	
<b>With indicator &amp; by-pass</b> 		N.C.	○	○	○	○	○	

- LVQ
- LVA
- LVH
- LVQ
- LVP
- LVW
- LQ1
- LQ3
- LVN
- LQHB
- TL
- TIL
- TLM
- TILM
- TD
- TID
- TH
- TIH

## Specifications

Model		LVQ20H	LVQ30H	LVQ40H	LVQ50H	LVQ60H
Tubing O.D. <sup>Note 1)</sup>	Metric	6	10	12	19	25
	Inch	1/4	3/8	1/2	3/4	1
Orifice diameter		ø4	ø8	ø10	ø16	ø22
Flow rate characteristics	Kv	0.3	1.1	1.6	4.2	6.8 (8.1) <sup>Note 1)</sup>
	Cv	0.35	1.3	1.9	5	8 (9.5) <sup>Note 1)</sup>
Withstand pressure (MPa)		1				
Operating pressure <A→B flow>		-98 kPa to 0.5 MPa <sup>Note 3)</sup>				
Back pressure (MPa)		0.5 or less				
Valve leakage (cm <sup>3</sup> /min)		0 (With water pressure)				
Pilot air pressure (MPa)		0.5 to 0.8				
Pilot port size <sup>Note 2)</sup>		1/8" (ø3), ø4, Rc 1/8, NPT 1/8				
Fluid temperature (°C)		0 to 100				
Ambient temperature (°C)		0 to 60				
Weight (kg)		0.08	0.17	0.22	0.70	0.81

Note 1) ( ): High flow type

Note 2) Refer to page 846 for details of the applicable tubing sizes.

Note 3) This product cannot be used for vacuum retention. Also, connecting the vacuum to the B port may reduce the life of the product.

## Dimensions

Dimensions are the same as those of the standard specifications.

## Applicable Different Diameter Tubings with Reducer (LVQ□□H<sub>s</sub>V)

Different diameter tubings can be selected (within the same body class) by using a nut and an insert bushing (reducer). ● With reducer

Body class	Connection tubing O.D.													
	Metric size						Inch size							
	4	6	8	10	12	19	25	1/8	3/16	1/4	3/8	1/2	3/4	1
2	●	○	—	—	—	—	—	●	●	○	○	—	—	—
3	—	●	●	○	—	—	—	—	—	●	○	—	—	—
4	—	—	—	●	○	—	—	—	—	—	●	○	—	—
5	—	—	—	—	●	○	—	—	—	—	—	●	○	—
6	—	—	—	—	—	●	○	—	—	—	—	—	●	○

Note) Refer to page 804 for information on changing tubing sizes.



### ⚠ Specific Product Precautions

Be sure to read this before handling the products. Refer to back page 50 for Safety Instructions and pages 845 and 846 for Air Operated Chemical Liquid Valve Precautions.

### Piping

## ⚠ Caution

### 1. Connect tubing by special tools.

For information on tubing connection and special tools, please see the pamphlet "High Purity Fluoropolymer Fittings Hyper Fitting LQ1/2 Series Work Procedure Instructions" (M-E05-1) and "High Purity Fluoropolymer Fittings Hyper Fitting/Flare Type LQ3 Series Fitting Procedure" (M-E06-4). (The pamphlet can be downloaded from the SMC home page.)

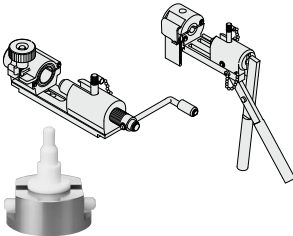

2. Tighten the nut until it touches the end surface of the body, and then tighten it an additional 1/8 turn. If the nut won't turn any further, then it means a sufficient tightening has occurred. Refer to the proper tightening torque shown below.

### Tightening Torque for Piping

Body class	Torque (N·m)		
	LQ1	LQ2	LQ3
2	0.3 to 0.4	1.5 to 2.0	1.6 to 1.8
3	0.8 to 1.0	3.0 to 3.5	3.2 to 3.5
4	1.0 to 1.2	7.5 to 9.0	5.0 to 5.3
5	2.5 to 3.0	11.0 to 13.0	10.0 to 10.5
6	5.5 to 6.0	—	22.5 to 23.0

LVQ

LVA

LVH

LVJ

LVK

LVP

LVW

LQ1

LQ3

LVN

LQHB

TL

TIL

TLM

TILM

TD

TID

TH

TIH





# LVQ Series Applicable Fluids

## Material and Fluid Compatibility Check List for Air Operated Chemical Valves

Chemical	Compatibility
Acetone	<input type="radio"/> Note 1, 2)
Ammonium hydroxide	<input type="radio"/> Note 2)
Isobutyl alcohol	<input type="radio"/> Note 1, 2)
Isopropyl alcohol	<input type="radio"/> Note 1, 2)
Hydrochloric acid	<input type="radio"/>
Ozone (dry)	<input type="radio"/>
Hydrogen peroxide Concentration 5% or less, 50°C or less	<input type="radio"/>
Ethyl acetate	<input type="radio"/> Note 1, 2)
Butyl acetate	<input type="radio"/> Note 1, 2)
Nitric acid (except fuming nitric acid) Concentration 10% or less	<input type="radio"/> Note 2)
Deionized water (pure water)	<input type="radio"/>
Sodium hydroxide (caustic soda) Concentration 50% or less	<input type="radio"/>
Nitrogen gas	<input type="radio"/>
Super pure water	<input type="radio"/>
Toluene	<input type="radio"/> Note 1, 2)
Hydrofluoric acid	<input type="radio"/> Note 2)
Sulfuric acid (except fuming sulfuric acid)	<input type="radio"/> Note 2)
Phosphoric acid Concentration 80% or less	<input type="radio"/>

Table symbols  : Can be used  
 : Can be used in certain conditions  
 : Cannot be used

The material and fluid compatibility check list provides reference values as a guide only.

Note 1) Since static electricity may be generated, implement suitable countermeasures.

Note 2) Use caution as permeation may occur. The permeated fluid may effect the parts of other materials.

- Compatibility is indicated for fluid temperatures of 100°C or less.
- The material and fluid compatibility check list provides reference values as a guide only, therefore we do not guarantee the application to our product.
- The data above is based on the information presented by the material manufacturers.
- SMC is not responsible for its accuracy and any damage happened because of this data.
- Use a fluid with a viscosity of 300 cp or less. Failure to do so may cause valve closing failure.



## LVQ Series

# Air Operated Chemical Liquid Valve/Precautions 1

Be sure to read this before handling the products.

### Design / Selection

#### ⚠ Warning

##### 1. Confirm the specifications.

Give careful consideration to operating conditions such as the application, fluid and environment, and use within the operating ranges specified in this catalog.

##### 2. Fluids

Operate after confirming the compatibility of the product's component materials with fluids, using the check list on page 844. Contact SMC regarding fluids other than those in the check list. Operate within the indicated fluid temperature range.

##### 3. Maintenance space

Ensure the necessary space for maintenance and inspections.

##### 4. Fluid pressure range

Keep the supplied fluid pressure within the operating pressure range specified in this catalog.

##### 5. Ambient environment

Install the product in an environment where there is no effect from radiant heat caused by heat sources, etc., and use within the ambient operating temperature range. After confirming the compatibility of the product's component materials with the ambient environment, operate so that fluid does not adhere to the product's exterior surfaces.

##### 6. Liquid seals

When circulating fluid

Provide a relief valve in the system so that fluid does not get into the liquid seal circuit.

##### 7. Countermeasures for static electricity

Since static electricity may be generated depending on the fluid being used, implement suitable countermeasures.

### Mounting

#### ⚠ Warning

##### 1. If air leakage increases or equipment does not operate properly, stop operation.

After mounting, perform suitable function and leak tests to confirm that the mounting is correct.

##### 2. Operation manual

Mount and operate the product after reading the manual carefully and understanding its contents. Also, keep the manual where it can be referred to as necessary.

### Piping

#### ⚠ Caution

##### 1. Preparation before piping

Before piping is connected, it should be thoroughly blown out with air (flushing) or washed to remove chips, cutting oil and other debris from inside the pipe.

Install piping so that it does not apply pulling, pressing, bending or other forces on the valve body.

##### 2. Use the tightening torques shown below for the threaded pilot port.

###### Tightening Torque for Pilot Port

Pilot port	Torque (N·m)
Rc, NPT 1/8	0.8 to 1.0

##### 3. Metal fittings

In the case of threaded pilot port, do not pipe the metal fittings which can cause damage to the thread part.

##### 4. For information on tubing connection and special tools, please see the pamphlet "High Purity Fluoropolymer Fittings Hyper Fitting LQ1/2 Series Work Procedure Instructions" (M-E05-1) or "High Purity Fluoropolymer Fittings Hyper Fitting/Flare Type LQ3 Series Fitting Procedure" (M-E06-4). (The pamphlets can be downloaded from the SMC home page.)

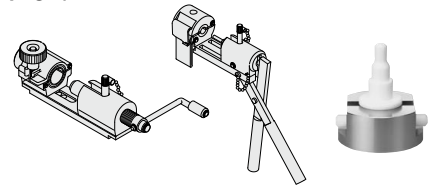

### Operating Air Supply

#### ⚠ Warning

##### 1. Use clean air.

Do not use compressed air which includes chemicals, synthetic oils containing organic solvents, salt, or corrosive gases, etc., as this may cause damage or malfunction.

LVC

LVA

LVH

LVD

LVQ

LVP

LVW

LQ1

LQ3

LVN

LQHB

TL

TIL

TLM

TILM

TD

TID

TH

TIH



## LVQ Series

# Air Operated Chemical Liquid Valve/Precautions 2

Be sure to read this before handling the products.

### Use of Tubing

#### ⚠ Caution

1. Refer to the applicable tubing sizes shown below for tubing to be used.

#### Applicable tubing sizes

	Connection tubing size	O.D. (mm)		Internal thickness (mm)	
		Standard size	Tolerance	Standard size	Tolerance
Metric sizes	ø3 x ø2	3.0	+0.2 -0.1	0.5	±0.06
	ø4 x ø3	4.0			
	ø6 x ø4	6.0			
	ø8 x ø6	8.0	+0.3 -0.1	1.0	±0.1
	ø10 x ø8	10.0			
	ø12 x ø10	12.0			
	ø19 x ø16	19.0			
ø25 x ø22	25.0	1.5	±0.15		
Inch sizes	1/8" x 0.086"	3.18	+0.2 -0.1	0.5	±0.1
	3/16" x 1/8"	4.75		0.8	
	1/4" x 5/32"	6.35		1.2	
	3/8" x 1/4"	9.53	+0.3 -0.1	1.6	±0.15
	1/2" x 3/8"	12.7			
	3/4" x 5/8"	19.0			
	1" x 7/8"	25.4			

### Operating Environment

#### ⚠ Warning

1. Do not use in a location having an explosive atmosphere.
2. Do not use in locations where vibration or impact occurs.
3. Do not use in locations where radiated heat will be received from nearby heat sources.
4. Do not use in environments which exceed the ambient temperature specifications of the product.

### Maintenance

#### ⚠ Warning

1. Maintenance should be performed in accordance with the procedures in the operation manual.

Incorrect handling can cause damage or malfunction of machinery and equipment, etc.

2. Before removing equipment or compressed air supply/exhaust devices, shut off the air and power supplies, and exhaust compressed air from the system.

Further, when restarting equipment after re-mounting or replacement, first confirm safety and then check the equipment for normal operation.

3. Perform work after removing residual chemicals and carefully replacing them with pure water or air, etc.
4. Do not disassemble the product. Products which have been disassembled cannot be guaranteed.

If disassembly is necessary, contact SMC.

5. In order to obtain optimum performance from valves, perform periodic inspections to confirm that there are no leaks from valves or fittings, etc.

### Maintenance

#### ⚠ Caution

1. Removal of drainage

Flush drainage from filters regularly.

### Precautions

#### ⚠ Warning

1. Operate within the ranges of the maximum operating pressure and back pressure.
2. Do not change the pilot port direction. Products which have been disassembled cannot be guaranteed.

#### ⚠ Caution

1. Please note that when the product is shipped from the factory, gases such as N<sub>2</sub> and air may leak from the valve at a rate of 1 cm<sup>3</sup>/min (when pressurized).

2. When operated at a very low flow rate, the product with flow rate adjustment may vibrate, etc. depending on the operating conditions. Therefore, operate only after careful examination of the flow rate, pressure and piping conditions.

3. Water hammering may occur depending on the fluid pressure conditions. In most cases, improvement is possible by adjusting the pilot pressure with a speed controller, etc., but the flow rate, pressure and piping conditions should be reviewed.

4. To adjust the flow rate with flow rate adjustment, open gradually starting from the fully closed condition.

Opening is accomplished by turning the adjustment knob counterclockwise.

Additionally, do not apply any unreasonable force to the adjustment handle when nearing a fully opened or closed condition. This may result in deformation of the orifice sheet surface or damage to the threaded part of the adjustment handle. The handle is in the fully closed condition when the product is shipped from the factory.

5. After long periods of nonuse, perform a test run before beginning regular operation.

6. Since the product is packaged in a clean room, use sufficient care in handling when opened.

### Return of Product

#### ⚠ Warning

If the product to be returned is contaminated or is possibly contaminated with substances that are harmful to humans, for safety reasons, please contact SMC beforehand and then employ a specialist cleaning company to decontaminate the product. After the decontamination prescribed above has been carried out, submit a Product Return Request Sheet or the Detoxification/Decontamination Certificate to SMC and await SMC's approval and further instructions before attempting to return the item.

Please refer to the International Chemical Safety Cards (ICSC) for a list of harmful substances.

If you have any further questions, please don't hesitate to contact your SMC sales representative.