

Air Slide Table

Reversible Type

ø6, ø8, ø12, ø16, ø20, ø25

New

Compliant to RoHS directive

Piping and adjuster positions can be changed on site to suit the installation conditions.

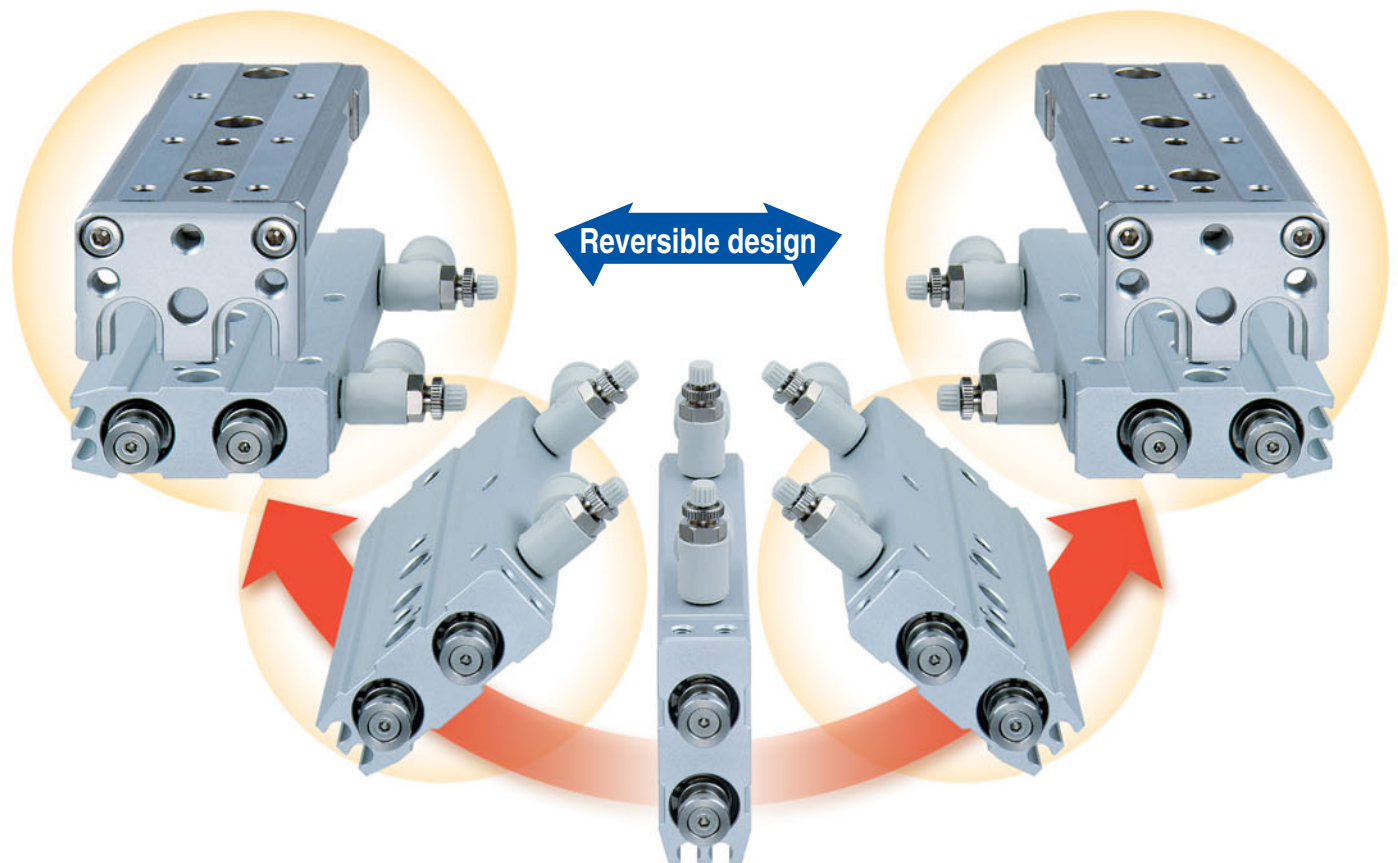

Application Examples

Transfer of two lines of small objects onto a pallet

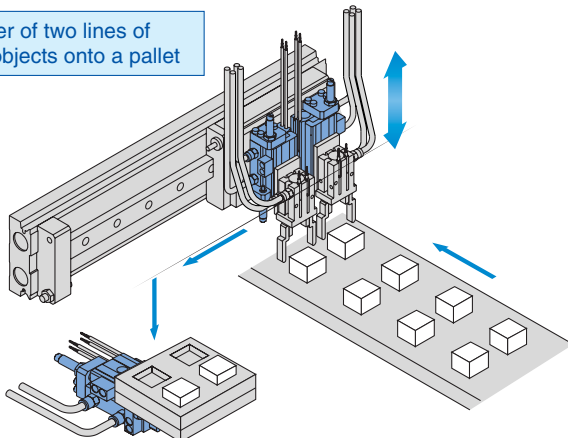

Sorting of work pieces of different shapes continuously supplied by a conveyor, etc.

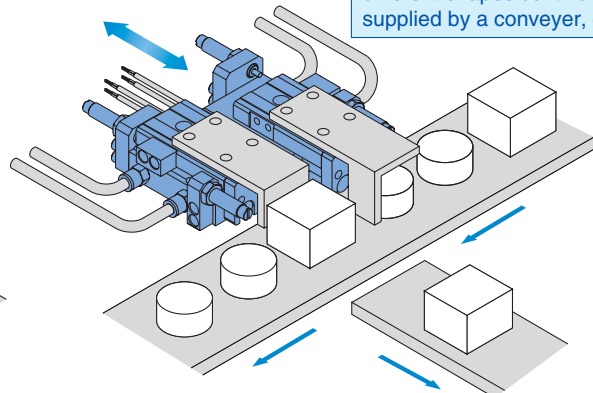

Series **MXQR**



CAT.ES20-203A

Integration of the guide rail and the table

Uses a recirculating linear guide for high rigidity and high precision.

Positioning hole
Improved body mounting repeatability

Adjuster and piping placed on the same plane
Located on the same plane to facilitate piping work.

Dual rod
Twice the output of conventional cylinders

Positioning hole
Improved workpiece mounting repeatability

Wide variety of adjuster options

Body mounting through-hole

Workpiece mounting tap

Improved strength
End plate uses extra super duralumin.

Integration of table and guide rail
Made of martensitic stainless steel

It is possible to mount two auto switches on the same plane.
The auto switch can be mounted into the groove made on the side of the body with no projection.

Recirculating linear guide
Wide type linear guide block body made of martensitic stainless steel

High Precision

Model	Accuracy (mm)	
	Parallelism	Height tolerance
MXQR12-30	0.035	±0.08

Air Slide Table/Interchangeable with the air slide table MXQ series.

The body and workpiece mounting dimensions are interchangeable with those of the MXQ series.

Three types of mounting. Wider choice of mounting variations facilitates installation.

① Lateral mounting (Body tapped)

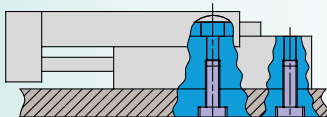

② Lateral mounting (Through hole)

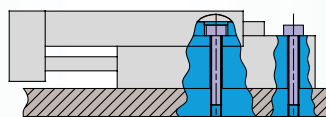

③ Vertical mounting (Body tapped)

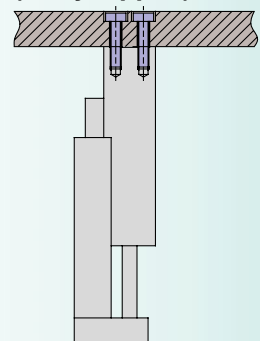

Shock absorber (soft type/short stroke RJ) can be mounted. (ø8 to ø25)

Improved cycle time,
suitable for short
strokes.



Shock absorber (RB) can be mounted on ø6.



Wide Variety of Adjuster (Option)

Rubber stopper on both ends



Extension stroke end shock absorber +
Retraction stroke end
rubber stopper



Shock absorber on both ends



Extension stroke end metal stopper +
Retraction stroke end
shock absorber



Metal stopper on both ends



Extension stroke end rubber stopper +
Retraction stroke end
metal stopper



How to change the adjuster

1 Remove the adjuster.

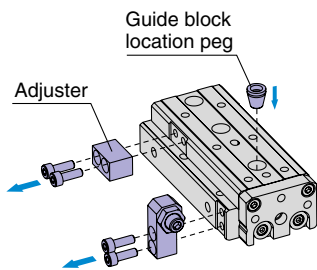

2 Reverse the body.

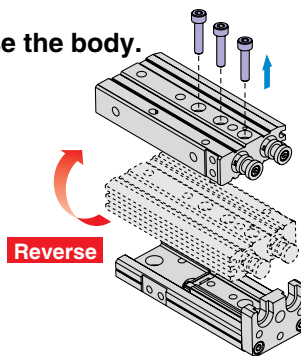

3 Refit → Completed

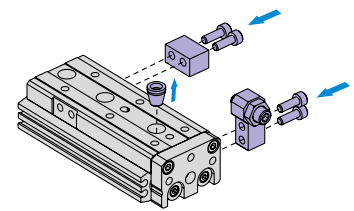

Variations

Model	Bore size (mm)	Standard stroke (mm)									Adjuster (Option)								
		10	20	30	40	50	75	100	125	150	Rubber stopper			Shock absorber			Metal stopper		
											Extension stroke end	Retraction stroke end	Both ends	Extension stroke end	Retraction stroke end	Both ends	Extension stroke end	Retraction stroke end	Both ends
MXQR 6	6	●	●	●	●	●					●	●	●	()	()	()	●	●	●
MXQR 8	8	●	●	●	●	●	●				●	●	●	●	●	●	●	●	●
MXQR12	12	●	●	●	●	●	●	●			●	●	●	●	●	●	●	●	●
MXQR16	16	●	●	●	●	●	●	●	●		●	●	●	●	●	●	●	●	●
MXQR20	20	●	●	●	●	●	●	●	●	●	●	●	●	●	●	●	●	●	●
MXQR25	25	●	●	●	●	●	●	●	●	●	●	●	●	●	●	●	●	●	●

() The MXQR6 series does not have a shock absorber type (J, JS, JT).

Series MXQR Model Selection

Model Selection Step	Formula/Data	Selection Example						
<p>1 Operating Conditions</p> <p>Enumerate the operating conditions considering the mounting position and workpiece configuration.</p>	<ul style="list-style-type: none"> • Model to be used • Type of cushion • Workpiece mounting position • Mounting orientation • Average speed Va (mm/s) • Load weight W (kg): Fig. (1) • Overhang Ln (mm): Fig. (2) 	 <p>Cylinder: MXQR16-50 Cushion: Rubber stopper Workpiece table mounting Mounting: Horizontal wall mounting Average speed: Va = 300 [mm/s] Load weight: W = 1 [kg] L1 = 10 mm L2 = 30 mm L3 = 30 mm</p>						
<p>2 Kinetic Energy</p> <p>Find the kinetic energy E (J) of the load.</p> <p>Find the allowable kinetic energy Ea (J). Confirm that the kinetic energy of the load does not exceed the allowable kinetic energy.</p>	$E = \frac{1}{2} \cdot W \left(\frac{V}{1000} \right)^2$ <p>Collision speed $V = \frac{1.4}{\alpha_1} \cdot Va$ *) Correction factor (Reference values)</p> <p>$Ea = K \cdot E_{max}$</p> <p>Workpiece mounting coefficient K: Fig. (3)</p> <p>Max. allowable kinetic energy E_{max}: Table (1)</p> <p>Kinetic energy (E) ≤ Allowable kinetic energy (Ea)</p>	$E = \frac{1}{2} \cdot 1 \cdot \left(\frac{420}{1000} \right)^2 = 0.088$ <p>$V = 1.4 \times 300 = 420$</p> <p>$Ea = 1 \times 0.11 = 0.11$</p> <p>Can be used based on $E = 0.088 \leq Ea = 0.11$</p>						
<p>3 Load Factor</p>								
<p>3-1 Load Factor of Load Weight</p> <p>Find the allowable load weight Wa (kg). Note) No need to consider this load factor in the case of using perpendicularly in a vertical position. (Define $\alpha_1 = 0.$)</p> <p>Find the load factor of the load weight α_1.</p>	<p>$Wa = K \cdot \beta \cdot W_{max}$</p> <p>Workpiece mounting coefficient K: Fig. (3)</p> <p>Allowable load weight coefficient β: Graph (1)</p> <p>Max. allowable load weight W_{max}: Table (2)</p> <p>$\alpha_1 = W/Wa$</p>	<p>$Wa = 1 \times 1 \times 4 = 4$</p> <p>$K = 1$</p> <p>$\beta = 1$</p> <p>$W_{max} = 4$</p> <p>$\alpha_1 = 1/4 = 0.25$</p>						
<p>3-2 Load Factor of the Static Moment</p> <p>Find the static moment M (N·m).</p> <p>Find the allowable static moment Ma (N·m).</p> <p>Find the load factor α_2 of the static moment.</p>	<p>$M = W \times 9.8 (Ln + An)/1000$ Correction value of moment center position distance An: Table (3)</p> <p>$Ma = K \cdot \gamma \cdot M_{max}$</p> <p>Workpiece mounting coefficient K: Fig. (3)</p> <p>Allowable moment coefficient γ: Graph (2)</p> <p>Maximum allowable moment M_{max}: Table (4)</p> <p>$\alpha_2 = M/Ma$</p>	<table border="0"> <tr> <td style="border: 1px solid black; padding: 2px;">Yawing</td> <td style="border: 1px solid black; padding: 2px;">Rolling</td> </tr> <tr> <td>Examine My. $My = 1 \times 9.8 (10 + 30)/1000 = 0.39$ $A3 = 30$ $May = 1 \times 1 \times 18 = 18$ $M_{ymax} = 18$ $K = 1$ $\gamma = 1$</td> <td>Examine Mr. $Mr = 1 \times 9.8 (30 + 10.5)/1000 = 0.39$ $A6 = 10.5$ $Mar = 36$ $M_{rmax} = 36$ $K = 1$ $\gamma = 1$</td> </tr> <tr> <td>$\alpha_2 = 0.39/18 = 0.022$</td> <td>$\alpha_2 = 0.39/36 = 0.011$</td> </tr> </table>	Yawing	Rolling	Examine My. $My = 1 \times 9.8 (10 + 30)/1000 = 0.39$ $A3 = 30$ $May = 1 \times 1 \times 18 = 18$ $M_{ymax} = 18$ $K = 1$ $\gamma = 1$	Examine Mr. $Mr = 1 \times 9.8 (30 + 10.5)/1000 = 0.39$ $A6 = 10.5$ $Mar = 36$ $M_{rmax} = 36$ $K = 1$ $\gamma = 1$	$\alpha_2 = 0.39/18 = 0.022$	$\alpha_2 = 0.39/36 = 0.011$
Yawing	Rolling							
Examine My. $My = 1 \times 9.8 (10 + 30)/1000 = 0.39$ $A3 = 30$ $May = 1 \times 1 \times 18 = 18$ $M_{ymax} = 18$ $K = 1$ $\gamma = 1$	Examine Mr. $Mr = 1 \times 9.8 (30 + 10.5)/1000 = 0.39$ $A6 = 10.5$ $Mar = 36$ $M_{rmax} = 36$ $K = 1$ $\gamma = 1$							
$\alpha_2 = 0.39/18 = 0.022$	$\alpha_2 = 0.39/36 = 0.011$							
<p>3-3 Load Factor of Dynamic Moment</p> <p>Find the dynamic moment Me (N·m).</p> <p>Find the allowable dynamic moment Mea (N·m).</p> <p>Find the load factor α_3 of the dynamic moment.</p>	<p>$Me = 1/3 \cdot We \times 9.8 \frac{(Ln + An)}{1000}$</p> <p>Collision equivalent to impact $We = \delta \cdot W \cdot V$ δ: Bumper coefficient Rubber stopper without adjuster = 4/100 Shock absorber = 1/100 Metal stopper = 16/100 Correction value of moment center position distance An: Table (3)</p> <p>$Mea = K \cdot \gamma \cdot M_{max}$</p> <p>Workpiece mounting coefficient K: Fig. (3)</p> <p>Allowable moment coefficient γ: Graph (2)</p> <p>Max. allowable moment M_{max}: Table (4)</p> <p>$\alpha_3 = Me/Mea$</p>	<table border="0"> <tr> <td style="border: 1px solid black; padding: 2px;">Pitching</td> <td>Examine Mep. $Mep = 1/3 \times 16.8 \times 9.8 \times \frac{(30 + 10.5)}{1000} = 2.2$ $We = 4/100 \times 1 \times 420 = 16.8$ $A2 = 10.5$ $Meap = 1 \times 0.7 \times 18 = 12.6$ $K = 1$ $\gamma = 0.7$ $M_{pmax} = 18$ $\alpha_3 = 2.2/12.6 = 0.17$</td> </tr> <tr> <td style="border: 1px solid black; padding: 2px;">Yawing</td> <td>Examine Mey. $Mey = 1/3 \times 16.8 \times 9.8 \times \frac{(30 + 24.5)}{1000} = 3.0$ $We = 16.8$ $A4 = 24.5$ $Meay = 12.6$ (Same value as Meap) $\alpha_3 = 3.0/12.6 = 0.24$</td> </tr> </table>	Pitching	Examine Mep. $Mep = 1/3 \times 16.8 \times 9.8 \times \frac{(30 + 10.5)}{1000} = 2.2$ $We = 4/100 \times 1 \times 420 = 16.8$ $A2 = 10.5$ $Meap = 1 \times 0.7 \times 18 = 12.6$ $K = 1$ $\gamma = 0.7$ $M_{pmax} = 18$ $\alpha_3 = 2.2/12.6 = 0.17$	Yawing	Examine Mey. $Mey = 1/3 \times 16.8 \times 9.8 \times \frac{(30 + 24.5)}{1000} = 3.0$ $We = 16.8$ $A4 = 24.5$ $Meay = 12.6$ (Same value as Meap) $\alpha_3 = 3.0/12.6 = 0.24$		
Pitching	Examine Mep. $Mep = 1/3 \times 16.8 \times 9.8 \times \frac{(30 + 10.5)}{1000} = 2.2$ $We = 4/100 \times 1 \times 420 = 16.8$ $A2 = 10.5$ $Meap = 1 \times 0.7 \times 18 = 12.6$ $K = 1$ $\gamma = 0.7$ $M_{pmax} = 18$ $\alpha_3 = 2.2/12.6 = 0.17$							
Yawing	Examine Mey. $Mey = 1/3 \times 16.8 \times 9.8 \times \frac{(30 + 24.5)}{1000} = 3.0$ $We = 16.8$ $A4 = 24.5$ $Meay = 12.6$ (Same value as Meap) $\alpha_3 = 3.0/12.6 = 0.24$							
<p>3-4 Sum of the Load Factors</p> <p>Use is possible if the sum of the load factors does not exceed 1.</p>	<p>$\sum \alpha_n = \alpha_1 + \alpha_2 + \dots + \alpha_n \leq 1$</p>	<p>$\sum \alpha_n = \alpha_1 + \alpha_2 + \alpha_2' + \alpha_3 + \alpha_3'$ $= 0.25 + 0.022 + 0.011 + 0.17 + 0.24 = 0.693 \leq 1$</p> <p>And it is possible to use.</p>						

Fig. (1)
Load Weight: W (kg)



Note) No need to consider this load factor in the case of using perpendicularly in a vertical position.

Fig. (2) Overhang: L_n (mm), Correction Value of Moment Center Position Distance: A_n (mm)

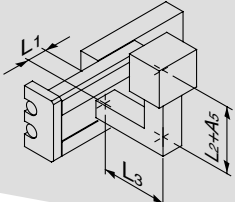
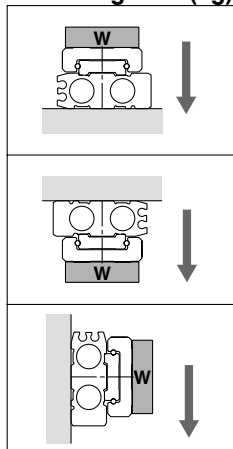
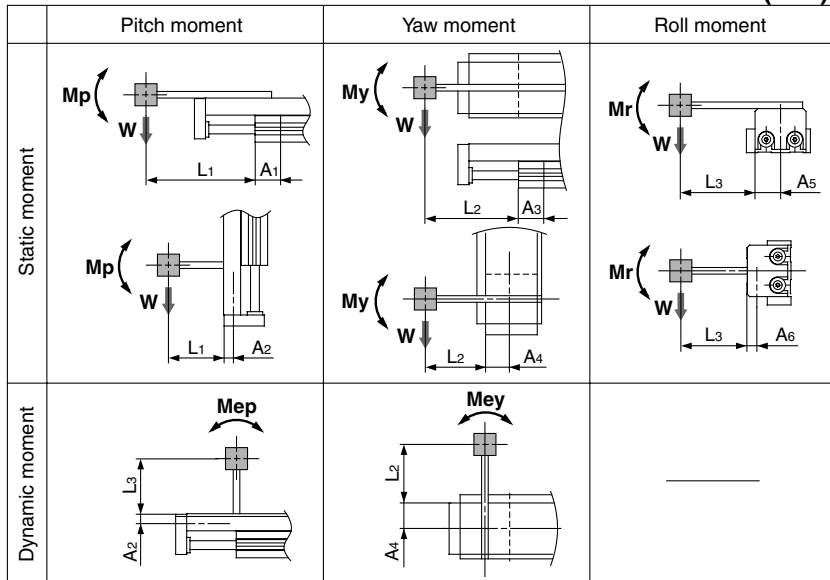

Note) Static moment: Moment generated by gravity
Dynamic moment: Moment generated by impact when colliding with stopper

Fig. (3) Workpiece Mounting Coefficient: K

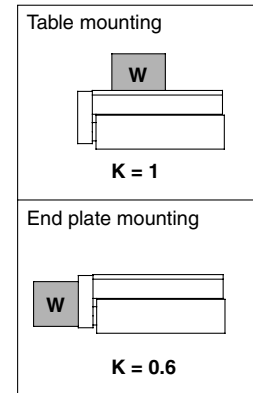

Table (1) Allowable Kinetic Energy: E_{max} (J)

Model	Allowable kinetic energy			
	Without adjuster	Adjuster option		
		Rubber stopper	Shock absorber	Metal stopper
MXQR 6	0.018	0.018	0.036	0.009
MXQR 8	0.027	0.027	0.054	0.013
MXQR12	0.055	0.055	0.11	0.027
MXQR16	0.11	0.11	0.22	0.055
MXQR20	0.16	0.16	0.32	0.080
MXQR25	0.24	0.24	0.48	0.12

⚠ Caution

- The maximum operating speed for the metal stopper type is 200 mm/s.
- When the shock absorber type is mounted vertically, operate within the maximum allowable load weight range shown in Table (2).
- The operating pressure range of the MXQR6 with shock absorber is 0.3 to 0.7 MPa.

Table (2) Maximum Allowable Load Weight: W_{max} (kg)

Model	Maximum allowable load weight
MXQR 6	0.6
MXQR 8	1
MXQR12	2
MXQR16	4
MXQR20	6
MXQR25	9

Graph (1) Allowable Load Weight Coefficient: β

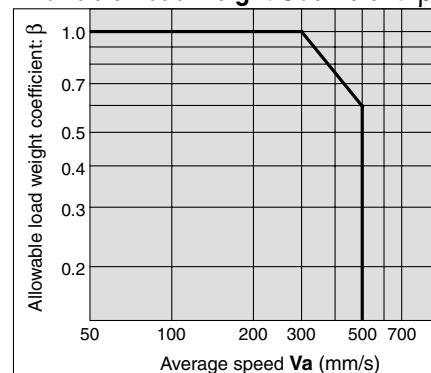

Table (3) Correction Value of Moment Center Position Distance: A_n (mm)

Model	Correction value of moment center position distance (Refer to Figure (2).)													
	A_1, A_3										A_2	A_4	A_5	A_6
	Stroke (mm)													
	10	20	30	40	50	75	100	125	150					
MXQR 6	14.5	14.5	14.5	18.5	18.5	—	—	—	—	6	13.5	13.5	6	
MXQR 8	16.5	16.5	18.5	20.5	28	28.5	—	—	—	7	16	16	7	
MXQR12	21	21	21	25	25	34	34	—	—	9	19.5	19.5	9	
MXQR16	27	27	27	27	30	33	42.5	42.5	—	10.5	24.5	24.5	10.5	
MXQR20	29.5	29.5	29.5	29.5	33.5	37.5	53.5	55	56.5	14	30	30	14	
MXQR25	35.5	35.5	35.5	35.5	43	43	50	64	64	16.5	37	37	16.5	

Note) For A_2, A_4, A_5 and A_6 , there is no difference in the corrected values due to the stroke.

Table (4) Maximum Allowable Moment: M_{max} (N·m)

Model	Pitch/Yaw moment: M_{pmax}/M_{ymax}										Roll moment: M_{rmax}							
	Stroke (mm)										Stroke (mm)							
		10	20	30	40	50	75	100	125	150	10	20	30	40	50	75	100	125
MXQR 6	1.4	1.4	1.4	2.8	2.8	—	—	—	—	3.5	3.5	3.5	5.1	5.1	—	—	—	—
MXQR 8	2.0	2.0	2.8	3.7	7.9	7.9	—	—	—	5.1	5.1	6.0	6.9	7.4	7.4	—	—	—
MXQR12	4.7	4.7	4.7	7.2	7.2	15	15	—	—	11	11	11	13	13	14	14	—	—
MXQR16	13	13	13	13	18	23	42	42	—	31	31	31	31	36	41	41	—	—
MXQR20	19	19	19	19	27	36	84	84	84	47	47	47	47	57	66	75	75	75
MXQR25	32	32	32	32	52	52	78	140	140	81	81	81	81	110	110	130	130	130

Graph (2) Allowable Moment Coefficient: γ

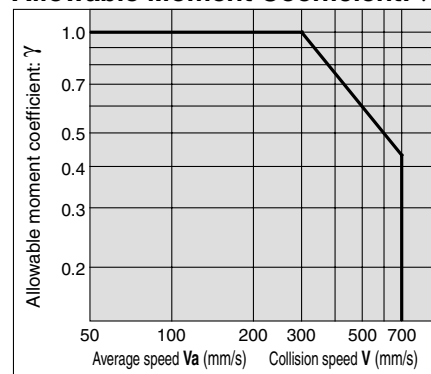

Note) Use the average speed when calculating static moment.
Use the collision speed when calculating dynamic moment.

Symbol

Symbol	Definition	Unit	Symbol	Definition	Unit
A_n ($n = 1$ to 6)	Correction value of moment center position distance	mm	V_a	Average speed	mm/s
E	Kinetic energy	J	W	Load weight	kg
E_{max}	Allowable kinetic energy	J	W_a	Allowable load weight	kg
L_n ($n = 1$ to 3)	Overhang	mm	W_e	Weight equivalent to impact	kg
M (M_p, M_y, M_r)	Static moment (Pitch, Yaw, Roll)	N·m	W_{max}	Max. allowable load weight	kg
M_a (M_{ap}, M_{ay}, M_{ar})	Allowable static moment (Pitch, Yaw, Roll)	N·m	α	Load factor	—
M_e (M_{ep}, M_{ey})	Dynamic moment (Pitch, Yaw)	N·m	β	Allowable load weight coefficient	—
M_{ea} (M_{eap}, M_{eay})	Allowable dynamic moment (Pitch, Yaw)	N·m	γ	Allowable moment coefficient	—
M_{max} ($M_{pmax}, M_{ymax}, M_{rmax}$)	Maximum allowable moment (Pitch, Yaw, Roll)	N·m	K	Workpiece mounting coefficient	—
V	Collision speed	mm/s			

Series MXQR

Adjuster Option: Shock Absorber Buffer Time (Reference Values)

* Buffer time: The time from when the product hits the rod end of the shock absorber to when the shock absorber reaches its retracted position.

MXQR8 Extension Stroke End

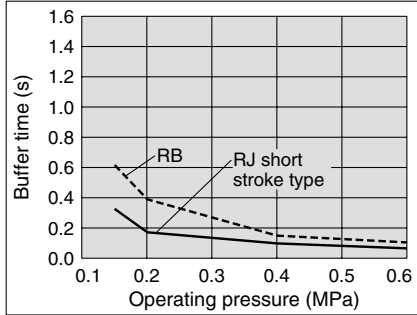

MXQR8 Retraction Stroke End

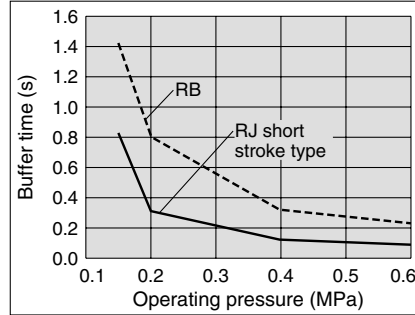

MXQR12 Extension Stroke End

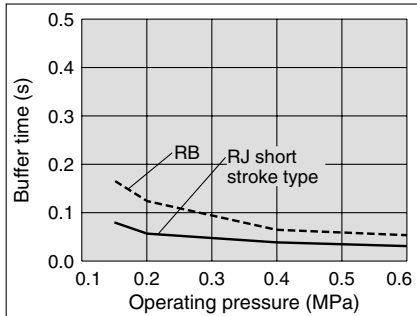

MXQR12 Retraction Stroke End

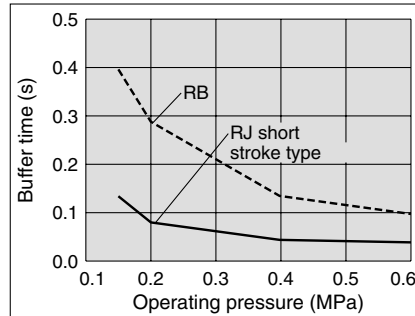

MXQR16 Extension Stroke End

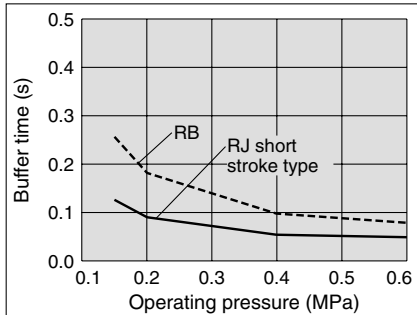

MXQR16 Retraction Stroke End

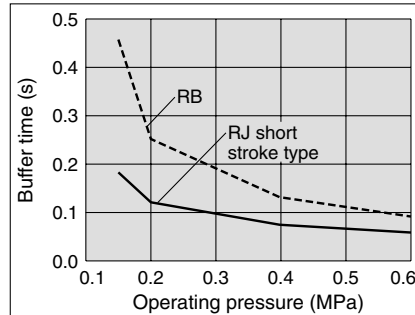

MXQR20 Extension Stroke End

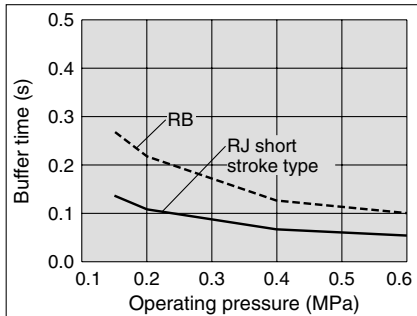

MXQR20 Retraction Stroke End

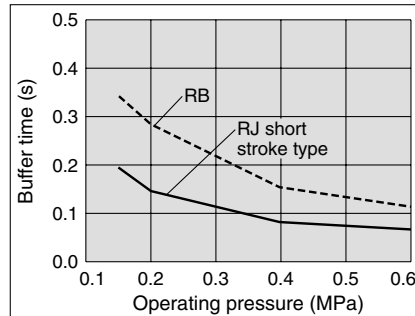

MXQR25 Extension Stroke End

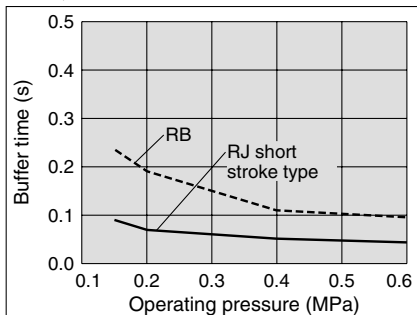

MXQR25 Retraction Stroke End

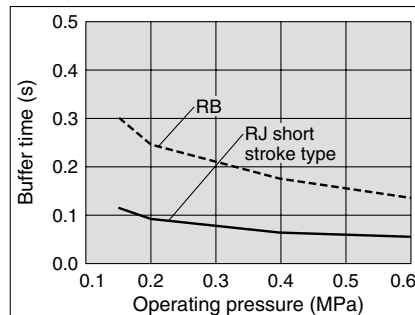

Test conditions

Workpiece weight: Approx. 70% of maximum load weight

Speed : Average speed with the fitting directly mounted (Approx. 300 to 500 mm/s depending on the bore size and operating pressure)

Selection

⚠ Caution

1. Operate loads within the range of the operating limits.

Select the model considering maximum load weight and allowable moment. Refer to front matters 1 and 2 for the details. When actuator is used outside of operating limits, eccentric loads on guide will be in excess of this causing vibration on guide, inaccuracy, and shortened life.

2. If intermediate stops by external stopper is done, avoid ejection.

If lurching occurs damage can result. When making a stop with an external stopper to be followed by continued forward movement, first supply pressure to momentarily reverse the table, then retract the intermediate stopper, and finally apply pressure to the opposite port to operate the table again.

Operating Environment

⚠ Caution

1. Do not use in the environment, where the product could be exposed to the liquid such as cutting oil, etc.

Using in the environment where the product could be exposed to cutting oil, coolant or oil, etc. could result in looseness, increased operating resistance, or air leakage, etc.

2. Do not use in the environment, where the product could be exposed directly to the foreign matters such as powder dust, blown dust, cutting chip, spatter, etc.

This could result in looseness and increased operating resistance, and air leakage, etc.

Please consult with SMC regarding use in this kind of environment.

3. Use caution for the anti-corrosiveness of linear guide section.

Martensitic stainless steel is used for the table and guide block. But, use caution that anti-corrosiveness is inferior to the austenitic stainless steel. Especially, rust may be generated in an environment where waterdrops are likely to adhere due to condensation, etc.

Note) The buffer time depends on the operating conditions (maximum load weight, moment, piston speed and operating pressure and temperature).

Air Slide Table/Reversible Type

Series MXQR

ø6, ø8, ø12, ø16, ø20, ø25

How to Order

MXQR 12 **L** - **50** **J** - **M9BW** - **□** - **□**

Air Slide Table/Reversible Type

Port thread type

Nil	M thread	ø6 to ø16
	Rc	
TN	NPT	ø20, ø25
TF	G	

Adjuster position set at the time of shipment*

L		Nil	
Left side		Right side	
Adjuster		Adjuster	
Table		Table	

* The adjuster position can be selected from two choices, right side and left side. It can be changed on site to suit the installation conditions. For detailed dimensions, refer to the product drawing. For the procedure for changing the position, refer to the **MXQR Operation Manual**.

Made to Order
Refer to page 2 for details.

Auto switch

Nil	Without auto switch (Built-in magnet)
-----	---------------------------------------

* For applicable auto switch models, refer to the below table.

Number of auto switches

Nil	2 pcs.
S	1 pc.
n	"n" pcs.

Adjuster options

		Retraction stroke end				
		None	Adjuster (Rubber stopper)	Shock absorber (RB)	Adjuster (Metal stopper)	Shock absorber RJ Note 1, 2 (Short stroke type)
Extension stroke end	None	Nil	AT	BT	CT	JT
	Adjuster (Rubber stopper)	AS	A	ASBT	ASCT	ASJT
	Shock absorber (RB)	BS	BSAT	B	BSCT	BSJT
	Adjuster (Metal stopper)	CS	CSAT	CSBT	C	CSJT
	Shock absorber RJ Note 1, 2 (Short stroke type)	JS	JSAT	JSBT	JSCT	J

Note 1) The shock absorber RJ (short stroke type) is a soft and short stroke type shock absorber (RJ□). For the buffer time, refer to front matter 3. For details of the shock absorber (RJ), refer to its catalog.

Note 2) The shock absorber (short stroke type) is not available with the MXQR6.

Bore size (Stroke (mm))

ø6	10, 20, 30, 40, 50
ø8	10, 20, 30, 40, 50, 75
ø12	10, 20, 30, 40, 50, 75, 100
ø16	10, 20, 30, 40, 50, 75, 100, 125
ø20	10, 20, 30, 40, 50, 75, 100, 125, 150
ø25	10, 20, 30, 40, 50, 75, 100, 125, 150

Applicable Auto Switches/Refer to Best Pneumatics No. 3 for further information on auto switches.

Type	Special function	Electrical entry	Indicator light	Wiring (Output)	Load voltage		Auto switch model		Lead wire length (m)				Pre-wired connector	Applicable load						
					DC	AC	Perpendicular	In-line	0.5 (Nil)	1 (M)	3 (L)	5 (Z)								
Solid state auto switch	—	Grommet	Yes	3-wire (NPN)	24 V	5 V, 12 V	—	M9NV	M9N	●	—	●	○	○	IC circuit	Relay, PLC				
				3-wire (PNP)				M9PV	M9P	●	—	●	○							
				2-wire				M9BV	M9B	●	—	●	○							
				3-wire (NPN)				M9NWV	M9NW	●	●	●	○							
	Diagnostic indication (2-color indication)			Grommet	Yes	3-wire (PNP)	24 V	5 V, 12 V	—	M9PWV	M9PW	●	●	●			○	○	IC circuit	Relay, PLC
						2-wire				M9BWV	M9BW	●	●	●			○	○		
						3-wire (NPN)				M9NAV ^{*1}	M9NA ^{*1}	○	○	●			○	○	IC circuit	
						3-wire (PNP)				M9PAV ^{*1}	M9PA ^{*1}	○	○	●			○	○	IC circuit	
Water resistant (2-color indication)	Grommet	Yes	2-wire	24 V	12 V	—	M9BAV ^{*1}	M9BA ^{*1}	○	○	●	○	○	—	—					
			3-wire (NPN equivalent)				A96V	A96	●	—	●	—	—	IC circuit						
			2-wire				100 V	A93V ^{*2}	A93	●	●	●	—	—		—	Relay, PLC			
							100 V or less	A90V	A90	●	—	●	—	—		—	IC circuit			

*1 Water resistant type auto switches can be mounted on the above models, but in such case SMC cannot guarantee water resistance.

*2 1 m type lead wire is only applicable to D-A93.

* Lead wire length symbols: 0.5 m Nil (Example) M9NW
 1 m M (Example) M9NWM
 3 m L (Example) M9NWL
 5 m Z (Example) M9NWZ

* Solid state auto switches marked with "○" are produced upon receipt of order.

* Since there are other applicable auto switches than listed, refer to page 26 for details.

* For details about auto switches with pre-wired connector, refer to pages 1784 and 1785 of Best Pneumatics No. 3.

* Auto switches are shipped together, (but not assembled).

Series MXQR



Made to Order
(For details, refer to pages 28 to 29.)

Symbol	Specifications
-X7	PTFE grease
-X9	Grease for food processing equipment
-X11	Long adjustment bolt (Adjustment range: 15 mm)
-X12	Long adjustment bolt (Adjustment range: 25 mm)
-X16	Heat treated metal stopper bolt (Adjustment range: 5 mm)
-X17	Heat treated metal stopper bolt (Adjustment range: 15 mm)
-X18	Heat treated metal stopper bolt (Adjustment range: 25 mm)
-X33	Without built-in auto switch magnet
-X39	Fluororubber seal
-X42	Anti-corrosive guide unit
-X45	EPDM seal

Moisture Control Tube Series IDK



When operating an actuator with a small diameter and a short stroke at a high frequency, the dew condensation (water droplet) may occur inside the piping depending on the conditions.

Simply connecting the moisture control tube to the actuator will prevent dew condensation from occurring. For details, refer to [Series IDK in the WEB catalog](#).

Specifications

Bore size (mm)	6	8	12	16	20	25
Piping port size	M5 x 0.8				Rc1/8, NPT1/8, G1/8	
Fluid	Air					
Action	Double acting					
Operating pressure	0.15 to 0.7 MPa*					
Proof pressure	1.05 MPa					
Ambient and fluid temperature	-10 to 60°C					
Piston speed	50 to 500 mm/s (Adjuster option/Metal stopper: 50 to 200 mm/s) (Adjuster option/Shock absorber: 300 to 500 mm/s [ø6 only])					
Cushion	Rubber bumper (Standard, Adjuster option/Rubber stopper) Shock absorber (Adjuster option/Shock absorber) None (Adjuster option/Metal stopper)					
Lubrication	Not required (Non-lube)					
Auto switch	Reed auto switch (2-wire, 3-wire) Solid state auto switch (2-wire, 3-wire) 2-color indication solid state auto switch (2-wire, 3-wire)					
Stroke length tolerance	+1 0 mm					

* MXQR6 with shock absorber: Operating pressure 0.3 to 0.7 MPa

Standard Stroke

Model	Standard stroke (mm)
MXQR 6	10, 20, 30, 40, 50
MXQR 8	10, 20, 30, 40, 50, 75
MXQR12	10, 20, 30, 40, 50, 75, 100
MXQR16	10, 20, 30, 40, 50, 75, 100, 125
MXQR20	10, 20, 30, 40, 50, 75, 100, 125, 150
MXQR25	10, 20, 30, 40, 50, 75, 100, 125, 150

Theoretical Output

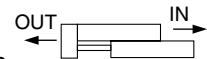

The dual rod ensures an output twice that of existing cylinders. (N)

Bore size (mm)	Rod size (mm)	Operating direction	Piston area (mm ²)	Operating pressure (MPa)					
				0.2	0.3	0.4	0.5	0.6	0.7
6	3	OUT	57	11	17	23	29	34	40
		IN	42	8	13	17	21	25	29
8	4	OUT	101	20	30	40	51	61	71
		IN	75	15	23	30	38	45	53
12	6	OUT	226	45	68	90	113	136	158
		IN	170	34	51	68	85	102	119
16	8	OUT	402	80	121	161	201	241	281
		IN	302	60	91	121	151	181	211
20	10	OUT	628	126	188	251	314	377	440
		IN	471	94	141	188	236	283	330
25	12	OUT	982	196	295	393	491	589	687
		IN	756	151	227	302	378	454	529

(Note) Theoretical output (N) = Pressure (MPa) x Piston area (mm²)

Weight

Model	Standard stroke (mm)									Additional weight of adjuster option					
	10	20	30	40	50	75	100	125	150	Rubber stopper		Shock absorber		Metal stopper	
										Extension stroke end	Retraction stroke end	Extension stroke end	Retraction stroke end	Extension stroke end	Retraction stroke end
MXQR 6	100	120	140	180	200	—	—	—	—	6	5	14	10	10	5
MXQR 8	140	170	210	250	315	385	—	—	—	10	10	30	23	23	10
MXQR12	335	340	380	450	490	655	745	—	—	25	23	47	30	35	23
MXQR16	605	610	670	735	835	1000	1250	1400	—	45	40	75	53	60	40
MXQR20	1100	1100	1100	1200	1400	1750	2350	2650	2900	80	65	170	120	115	65
MXQR25	1750	1750	1750	1950	2400	2750	3450	4300	4700	130	110	220	140	180	110

Optional Specifications

Adjusters

Three different types of adjusting bolt have been standardized for extension stroke end, retraction stroke end and both ends adjuster and cushion mechanisms.

■ **Rubber stopper**

Standard stroke adjuster

■ **Shock absorber**

Absorbs the impact at the stroke end for smooth stopping.
Improved stopping accuracy.

■ **Metal stopper**

Improved stopping accuracy.
Without cushioning function for use with light loads and low speeds.

Stroke Adjustment Range

Type	Description	Stroke adjustment range
Rubber stopper	Extension stroke end (AS)	0 to 5 mm
	Retraction stroke end (AT)	
	Both ends (A)	
Shock absorber	Extension stroke end (BS, JS)	Refer to "Dimensions".
	Retraction stroke end (BT, JT)	
	Both ends (B, J)	
Metal stopper	Extension stroke end (CS)	0 to 5 mm
	Retraction stroke end (CT)	
	Both ends (C)	

* Adjusters with wide adjustable range are available as option with rubber stopper and metal stopper. For detailed specifications, refer to "How to Order Stroke Adjuster (Accessories)" below.

Rubber stopper

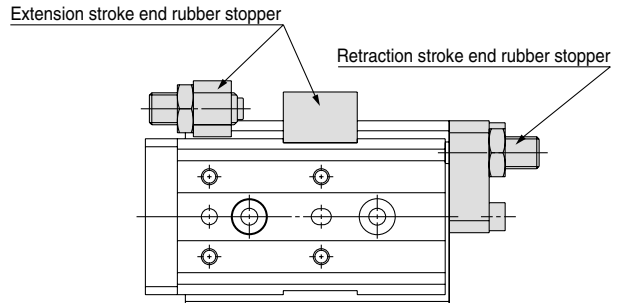

Shock absorber

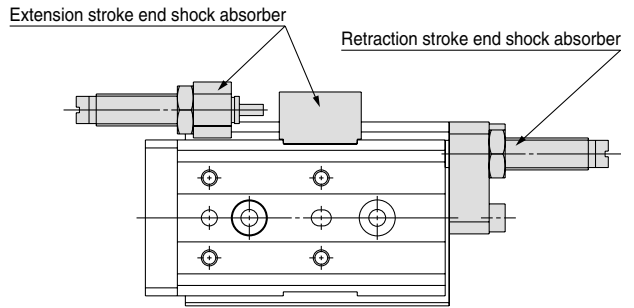

Metal stopper

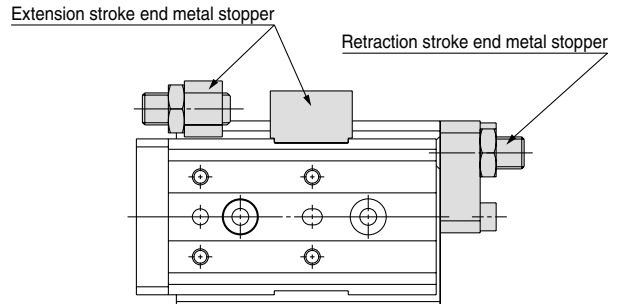

How to Order Stroke Adjuster (Accessories)

MXQR-AS 12-X11

Adjuster options

Code	Material	Stroke End
AS	Rubber stopper	Extension stroke end
AT	Rubber stopper	Retraction stroke end
BS	Shock absorber (RB)	Extension stroke end
BT		Retraction stroke end
CS	Metal stopper	Extension stroke end
CT		Retraction stroke end
JS	Shock absorber RJ short stroke type	Extension stroke end
JT		Retraction stroke end

Applicable bore size

6	ø6
8	ø8
12	ø12
16	ø16
20	ø20
25	ø25

Adjustment range

Nil	5 mm	Standard
-X11	15 mm	Option
-X12	25 mm	



Note 1) -X12 (adjustment range: 25 mm) is not available with the MXQR6 series.

Note 2) -X11 and -X12 are not available with shock absorber.

Note 3) Shock absorber (RJ) (JS, JT) is not available with the MXQR6 series.

Note 4) MXQR6 with shock absorber (RB) – Operating pressure 0.3 to 0.7 MPa

Operating piston speed 300 to 500 mm/s

Note 5) For dimensions, refer to pages 20 to 24.

* At the time of shipment, the standard mounting is applied.

Series MXQR

Table Accuracy

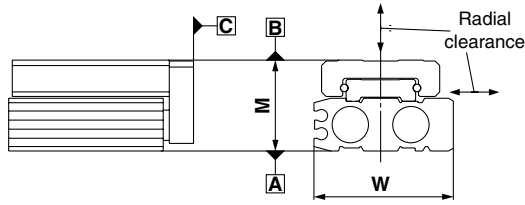

Model	MXQR6	MXQR8	MXQR12	MXQR16	MXQR20	MXQR25
B side parallelism to A side	Refer to Table (1).					
B side traveling parallelism to A side	Refer to Graph (1).					
C side perpendicularity to A side	0.05 mm					
M dimension tolerance	±0.08 mm (±0.1 mm)*					
W dimension tolerance	±0.1 mm					
Radial clearance (μm)	-4 to 0	-4 to 0	-6 to 0	-10 to 0	-12 to 0	-14 to 0

* ±0.1 mm for 75 mm or longer stroke

Table (1) B Side Parallelism to A Side (mm)

Model	Stroke (mm)								
	10	20	30	40	50	75	100	125	150
MXQR 6	0.025	0.03	0.035	0.04	0.045	—	—	—	—
MXQR 8	0.025	0.03	0.035	0.04	0.055	0.065	—	—	—
MXQR12	0.03	0.03	0.035	0.04	0.045	0.065	0.075	—	—
MXQR16	0.035	0.035	0.04	0.045	0.05	0.065	0.08	0.095	—
MXQR20	0.04	0.04	0.04	0.045	0.055	0.07	0.095	0.105	0.125
MXQR25	0.045	0.045	0.045	0.05	0.06	0.07	0.09	0.115	0.125

Graph (1) B Side Traveling Parallelism to A Side (mm)

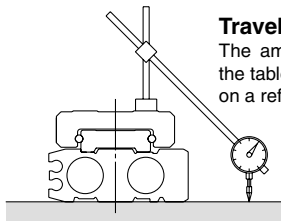
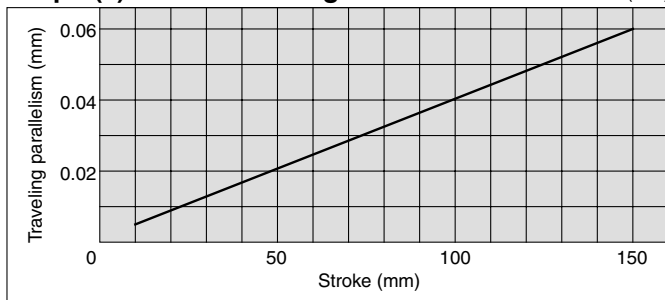

Traveling parallelism:

The amount of deflection on a dial gauge when the table travels a full stroke with the body secured on a reference base surface.

Shock Absorber Specifications

Shock absorber model	RB0604-X2062	RB0805	RB0806	RB1007	RB1411	RB1412	
Applicable slide table	MXQR6	MXQR8	MXQR12	MXQR16	MXQR20	MXQR25	
Max. absorbed energy (J)	0.5	0.98	2.94	5.88	14.7	19.6	
Stroke absorption (mm)	4	5	6	7	11	12	
Collision speed (mm/s)	300 to 500		50 to 500				
Max. operating frequency (cycle/min)	—	80	80	70	45	45	
Max. allowable thrust (N)	150	245	245	422	814	814	
Ambient temperature range (°C)	-10 to 60						
Spring force (N)	Extended	1.34	1.96	1.96	4.22	6.86	6.86
	Retracted	3.89	3.83	4.22	6.86	15.3	15.98
Weight (g)	5.5	15	15	25	65	65	

RJ Short Stroke Type Specifications

Shock absorber model	—	RJ0805	RJ1006	RJ1410		
Applicable slide table	MXQR6	MXQR8	MXQR12	MXQR16	MXQR20	MXQR25
Max. absorbed energy (J)	—	0.5	1.5	3.7	—	—
Stroke absorption (mm)	—	5	6	10	—	—
Collision speed (mm/s)	50 to 500					
Max. operating frequency (cycle/min)	—	80	70	45	—	—
Max. allowable thrust (N)	—	245	422	814	—	—
Ambient temperature range (°C)	-10 to 60°C (No freezing)					
Spring force (N)	Extended	2.8	5.4	6.4	—	—
	Retracted	4.9	8.0	14.6	—	—
Weight (g)	—	15	23	65	—	—

Note) The shock absorber service life is different from that of the MXQR cylinder depending on the operating conditions. Refer to the RB/RJ series Specific Product Precautions for the replacement period.

Service Life and Replacement Period of Shock Absorber

⚠ Caution

1. Allowable operating cycle under the specifications set in this catalog is shown below.

1.2 million cycles RB0604-X2062, RB08□□

2 million cycles RB10□□ to RB14□□

3 million cycles RJ0805 to RJ1410

Note) Specified service life (suitable replacement period) is the value at room temperature (20 to 25°C). The period may vary depending on the temperature and other conditions. In some cases the absorber may need to be replaced before the allowable operating cycle above.

Applicable size	Shock absorber model	
MXQR 6	RB0604-X2062	—
MXQR 8	RB0805	RJ0805
MXQR12	RB0806	
MXQR16	RB1007	RJ1006
MXQR20	RB1411	RJ1410
MXQR25	RB1412	

Mounting

⚠ Caution

1. Do not scratch or dent the mounting side of the body, table or end plate.

This can cause loss of parallelism in the mounting surfaces, vibration in the guide unit and increased operating resistance, etc.

2. Do not scratch or dent on the forward side of the rail or guide.

This could result in looseness and increased operating resistance, etc.

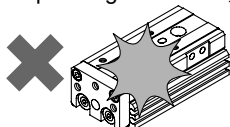

3. Do not apply excessive power and load when a workpiece is mounted.

If the external force more than the allowable moment were applied, looseness of the guide unit or increased operating resistance could take place.

4. Flatness of mounting surface should be 0.02 mm or less.

Poor parallelism of the workpiece mounted on the body, base and other parts can cause vibration in the guide unit and increased operating resistance, etc.

5. Keep away from objects which are influenced by magnets.

As the body magnets are built-in, do not allow close contact with magnetic disks, magnetic cards or magnetic tapes. Data may be erased.

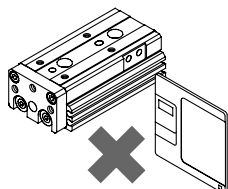

6. Do not touch a magnet to the table section.

Since the table is made from the magnetic substance, it could turn to be magnetized if it stuck by a magnet, etc. That could cause auto switches, etc. to malfunction.

7. When mounting the body, use screws with appropriate length and do not exceed the maximum tightening torque.

Tightening with a torque above the limit could malfunction. Whereas, tightening insufficiently could result in misalignment or come to a drop.

1. Lateral Mounting (Body tapped)

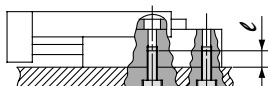

Model	Bolt	Maximum tightening torque (N·m)	Maximum screw-in depth (ℓ mm)
MXQR 6	M4 x 0.7	2.1	8
MXQR 8	M4 x 0.7	2.1	8
MXQR12	M5 x 0.8	4.4	10
MXQR16	M6 x 1	7.4	12
MXQR20	M6 x 1	7.4	12
MXQR25	M8 x 1.25	18.0	16

2. Lateral Mounting (Through hole)

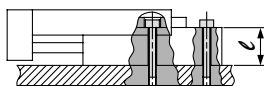

Model	Bolt	Maximum tightening torque (N·m)	Maximum screw-in depth (ℓ mm)
MXQR 6	M3 x 0.5	1.2	11.5
MXQR 8	M3 x 0.5	1.2	13.5
MXQR12	M4 x 0.7	2.8	17.4
MXQR16	M5 x 0.8	5.7	22.4
MXQR20	M5 x 0.8	5.7	27.4
MXQR25	M6 x 1	10.0	33.4

3. Vertical Mounting (Body tapped)

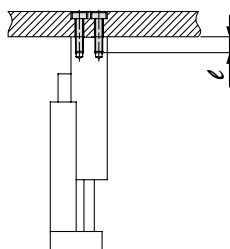

Model	Bolt	Maximum tightening torque (N·m)	Maximum screw-in depth (ℓ mm)
MXQR 6	M2.5 x 0.45	0.5	4
MXQR 8	M3 x 0.5	0.9	4
MXQR12	M4 x 0.7	2.1	6
MXQR16	M5 x 0.8	4.4	7
MXQR20	M5 x 0.8	4.4	8
MXQR25	M6 x 1	7.4	10

1. Front Mounting

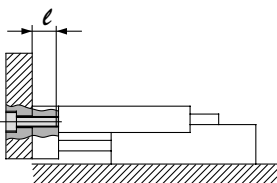

⚠ Caution

To prevent the workpiece fixing bolts from touching the end plate, use bolts that are 0.5 mm or shorter than the maximum screw-in depth. If long bolts are used, they can touch the end plate and cause malfunction, etc.

Model	Bolt	Maximum tightening torque (N·m)	Maximum screw-in depth (ℓ mm)
MXQR 6	M3 x 0.5	0.9	5
MXQR 8	M4 x 0.7	2.1	6
MXQR12	M5 x 0.8	4.4	8
MXQR16	M6 x 1	7.4	10
MXQR20	M6 x 1	7.4	13
MXQR25	M8 x 1.25	18.0	15

2. Top Mounting

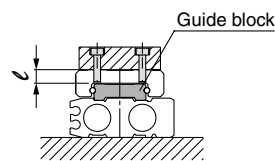

⚠ Caution

To prevent the workpiece holding bolts from touching the guide block, use bolts that are 0.5 mm or shorter than the maximum screw-in depth. If long bolts are used, they can touch the guide block and cause malfunction, etc.

Model	Bolt	Maximum tightening torque (N·m)	Maximum screw-in depth (ℓ mm)
MXQR 6	M3 x 0.5	1.2	4
MXQR 8	M3 x 0.5	1.2	4.8
MXQR12	M4 x 0.7	2.8	6
MXQR16	M5 x 0.8	5.7	7
MXQR20	M5 x 0.8	5.7	9.5
MXQR25	M6 x 1	10.0	11.5

8. The positioning hole on the table and the positioning hole at the bottom of the body do not have the same center. Use these holes during reinstallation after the table has been removed for the maintenance of an identical product.

Handling of Adjuster when Mounted on the Left

⚠ Caution

1. Keep at least 3 mm between adjusters mounted on the right and left when they are side by side.

Otherwise, this could cause auto switches to malfunction.

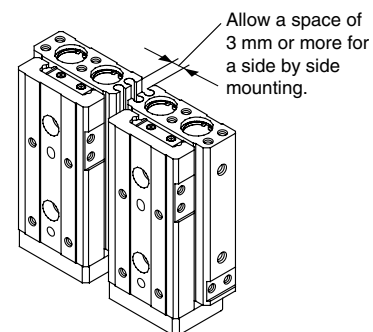

Series MXQR

Table Deflection (Reference Values)

Table displacement due to pitch moment load

Table displacement when loads are applied to the section marked with the arrow at the full stroke.

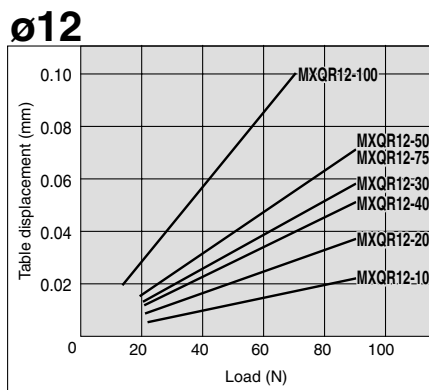
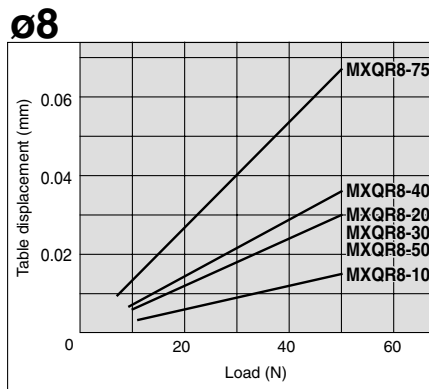
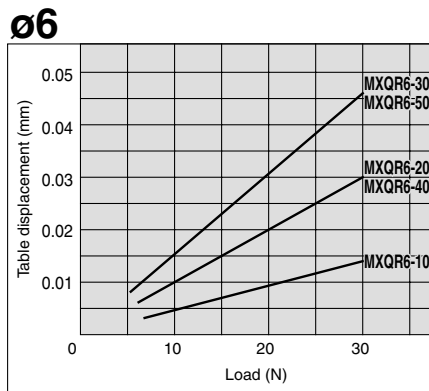

Table displacement due to yaw moment load

Table displacement when loads are applied to the section marked with the arrow at the full stroke.

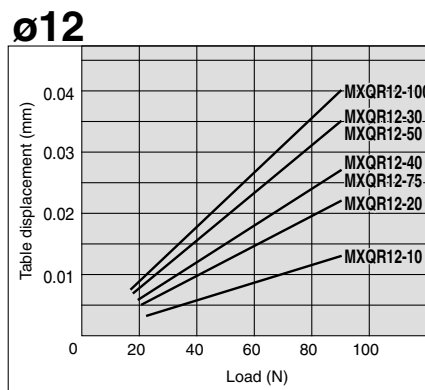
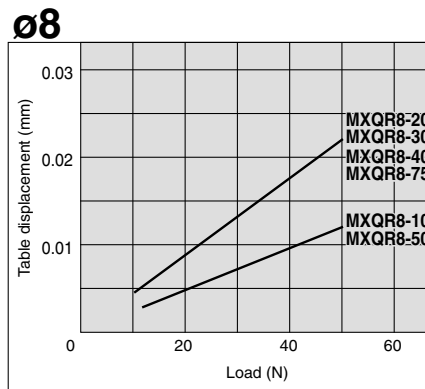
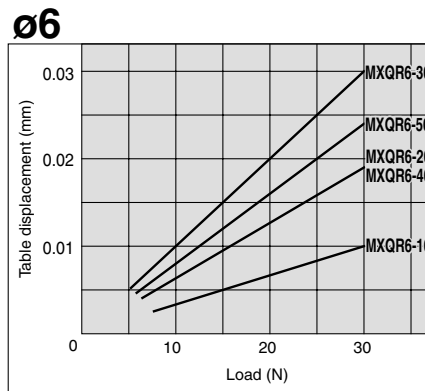
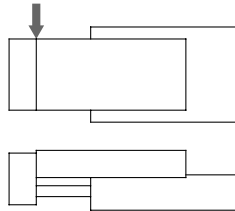
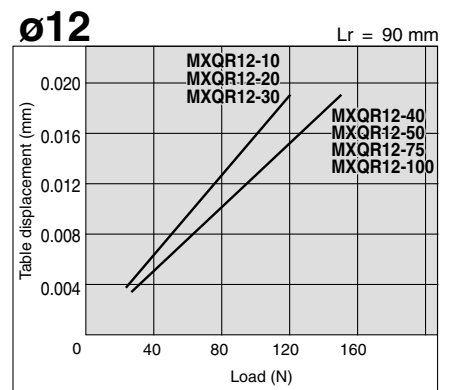
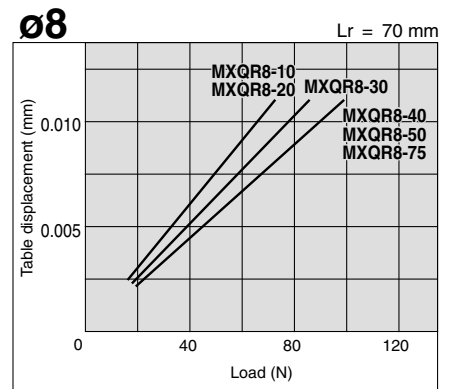
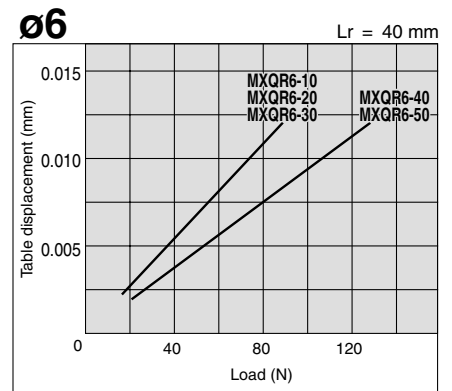
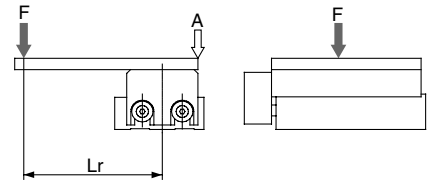

Table displacement due to roll moment load

Table displacement of section A when loads are applied to the section F with the slide table retracted.



Air Slide Table/Reversible Type *Series MXQR*

The below graphs show the table displacement when the static moment load is applied to the table. The graphs do not show the loadable weight. Refer to Model Selection for the loadable weight.

Table displacement due to pitch moment load

Table displacement when loads are applied to the section marked with the arrow at the full stroke.



ø16

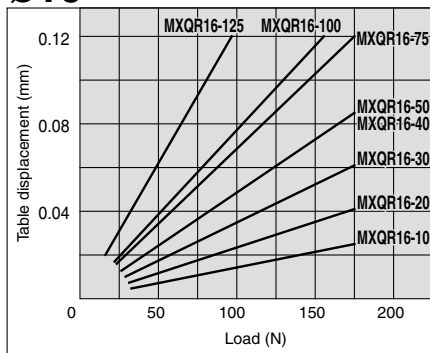

ø20

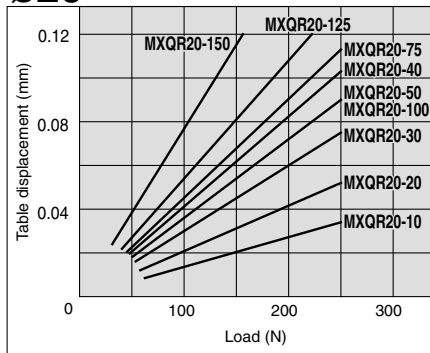

ø25

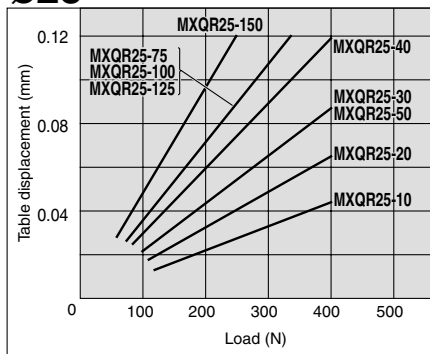
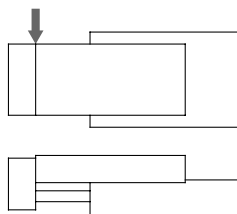
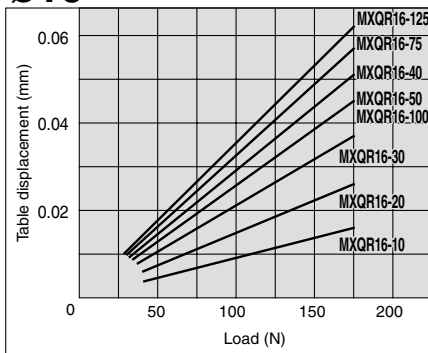

Table displacement due to yaw moment load

Table displacement when loads are applied to the section marked with the arrow at the full stroke.



ø16



ø20

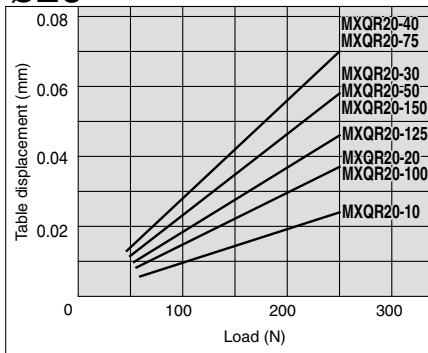

ø25

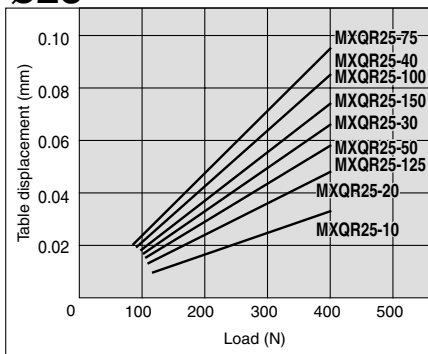
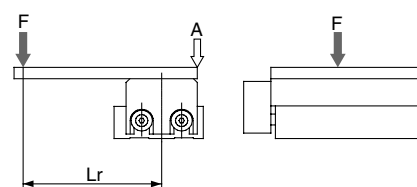
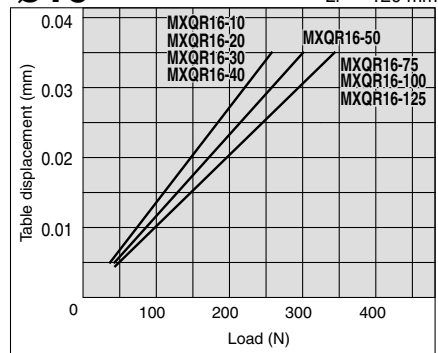

Table displacement due to roll moment load

Table displacement of section A when loads are applied to the section F with the slide table retracted.



ø16



ø20

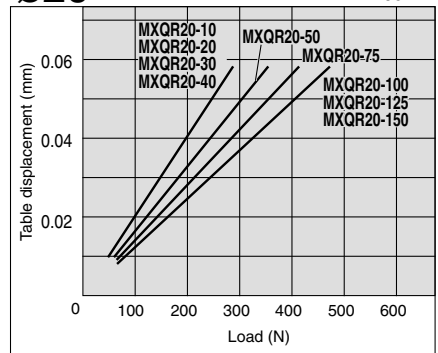

ø25

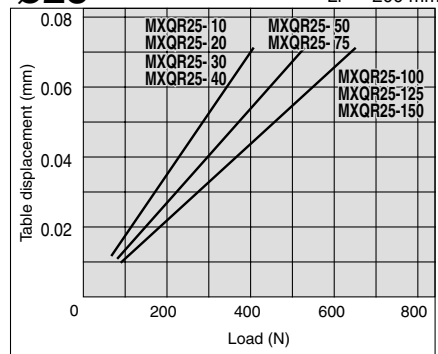

Series MXQR

Dimensions: MXQR 6

* For detailed dimensions about the stroke adjuster, refer to Adjuster Options.
 Rubber stopper (Refer to pages 20 and 21.)
 Shock absorber (Refer to page 22.)
 Metal stopper (Refer to pages 23 and 24.)

Mounting of adjuster on the right side

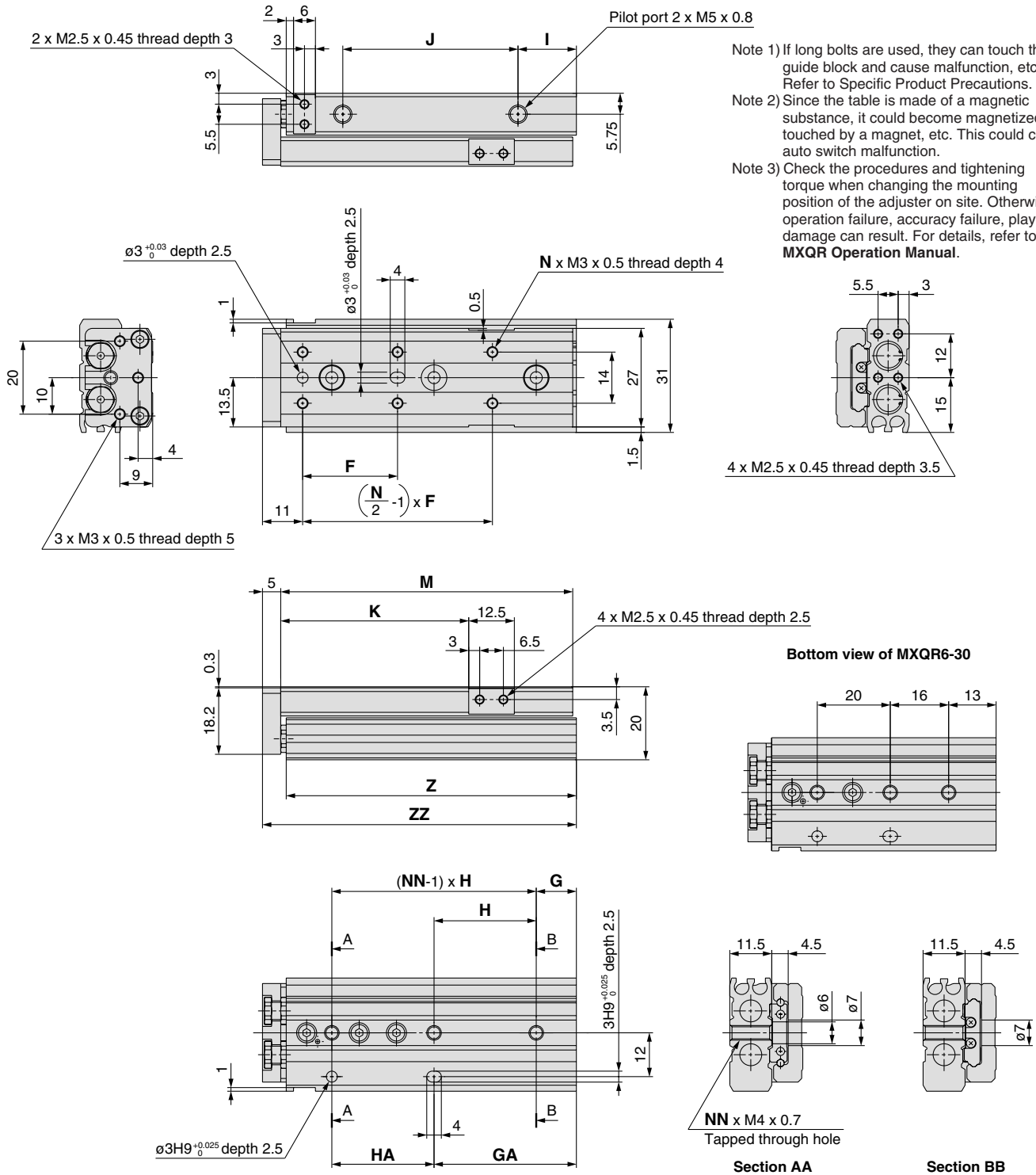

Note 1) If long bolts are used, they can touch the guide block and cause malfunction, etc. Refer to Specific Product Precautions.
 Note 2) Since the table is made of a magnetic substance, it could become magnetized if touched by a magnet, etc. This could cause auto switch malfunction.
 Note 3) Check the procedures and tightening torque when changing the mounting position of the adjuster on site. Otherwise, operation failure, accuracy failure, play and damage can result. For details, refer to the **MXQR Operation Manual**.

(mm)

Model	F	N	G	H	NN	GA	HA	I	J	K	M	Z	ZZ
MXQR6-10	22	4	6	23	2	13	16	9	17	21.5	42	41.5	48
MXQR6-20	25	4	13	26	2	13	26	9	27	31.5	52	51.5	58
MXQR6-30	21	6	Note)	Note)	3	29	20	9	37	41.5	62	61.5	68
MXQR6-40	26	6	11	28	3	39	28	16	48	51.5	80	79.5	86
MXQR6-50	27	6	21	28	3	49	28	9	65	61.5	90	89.5	96

Note) Refer to the bottom view of the MXQR6-30.

Mounting of adjuster on the left side

* Other dimensions are the same as those for mounting the adjuster on the right side.

- Note 1) If long bolts are used, they can touch the guide block and cause malfunction, etc. Refer to Specific Product Precautions.
 Note 2) Since the table is made of a magnetic substance, it could become magnetized if touched by a magnet, etc. This could cause auto switch malfunction.
 Note 3) Check the procedures and tightening torque when changing the mounting position of the adjuster on site. Otherwise, operation failure, accuracy failure, play and damage can result. For details, refer to the **MXQR Operation Manual**.

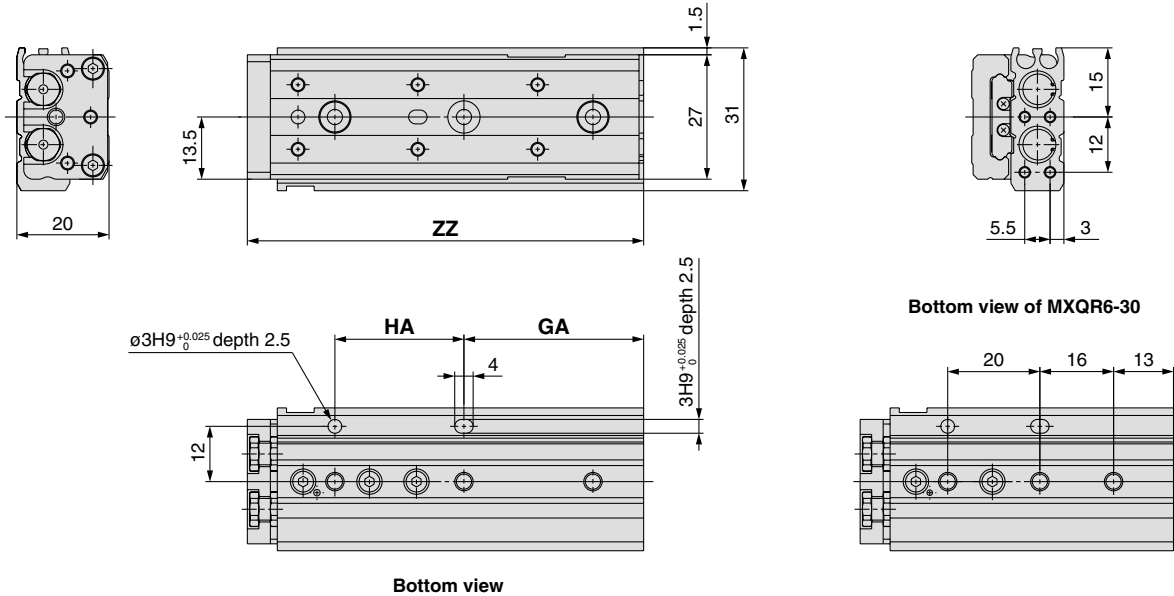

Adjuster Options

With rubber stopper ($\phi 6$): MXQR6(L)-□□AS, AT, A

Stroke Adjustable Range (mm)

Extension stroke end	Retraction stroke end
5	5

* Other dimensions are the same as those for mounting the adjuster on the right side.

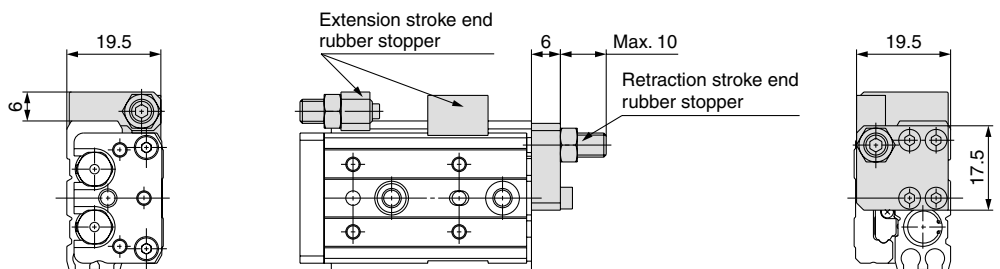

With shock absorber ($\phi 6$): MXQR6(L)-□□BS, BT, B

Stroke Adjustable Range (mm)

Extension stroke end	Retraction stroke end
12	12

* Other dimensions are the same as those for mounting the adjuster on the right side.

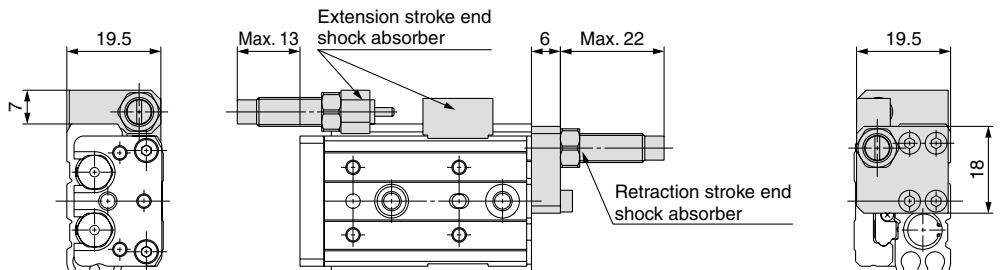

With metal stopper ($\phi 6$): MXQR6(L)-□□CS, CT, C

Stroke Adjustable Range (mm)

Extension stroke end	Retraction stroke end
5	5

* Other dimensions are the same as those for mounting the adjuster on the right side.

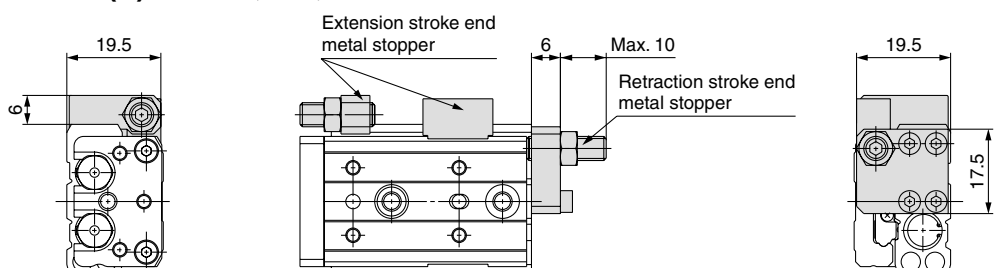

Series MXQR

Dimensions: MXQR 8

Mounting of adjuster on the right side

* For detailed dimensions about the stroke adjuster, refer to Adjuster Options.
 Rubber stopper (Refer to pages 20 and 21.)
 Shock absorber (Refer to page 22.)
 Metal stopper (Refer to pages 23 and 24.)

Note 1) If long bolts are used, they can touch the guide block and cause malfunction, etc. Refer to Specific Product Precautions.
 Note 2) Since the table is made of a magnetic substance, it could become magnetized if touched by a magnet, etc. This could cause auto switch malfunction.
 Note 3) Check the procedures and tightening torque when changing the mounting position of the adjuster on site. Otherwise, operation failure, accuracy failure, play and damage can result. For details, refer to the **MXQR Operation Manual**.

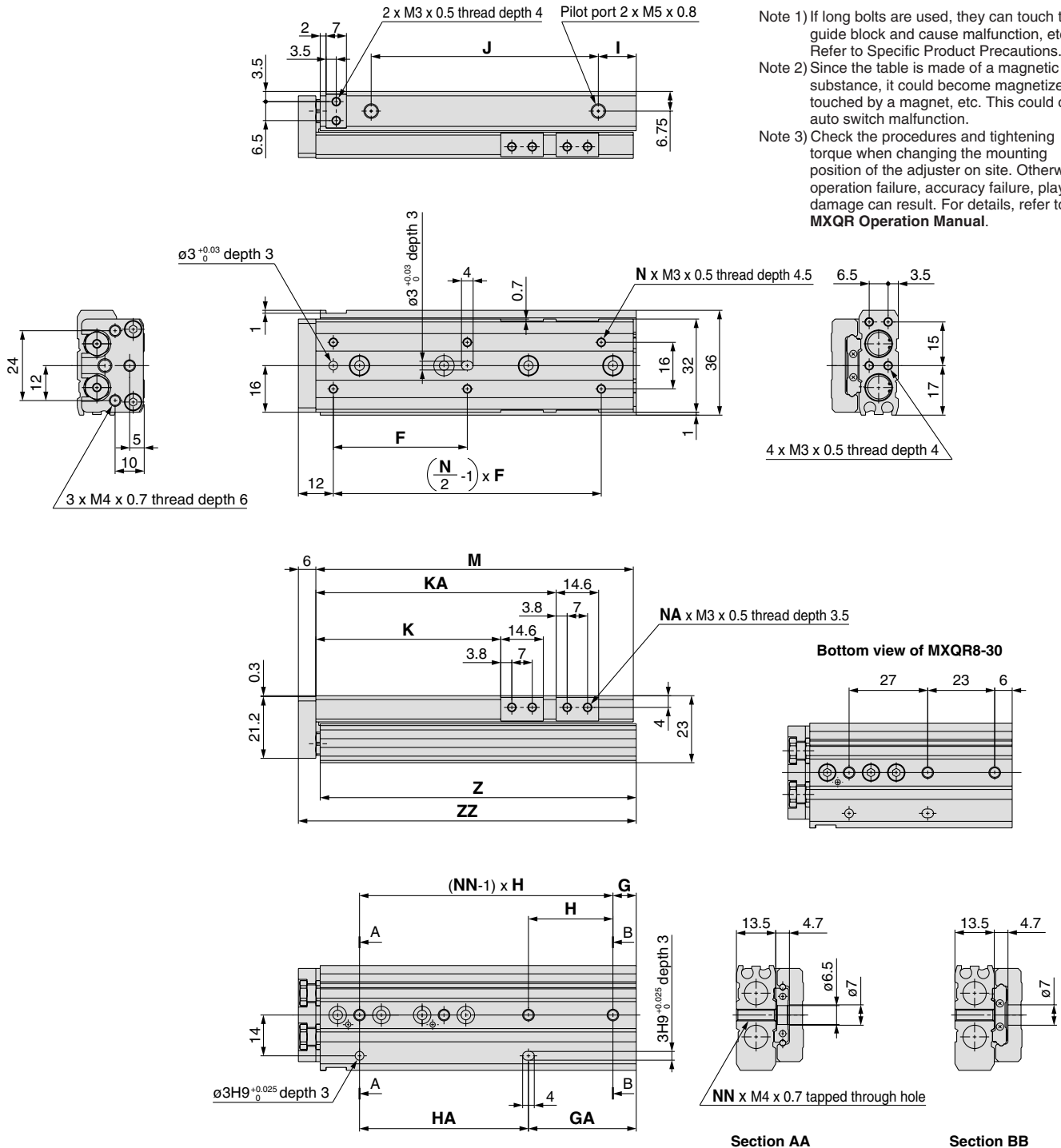

(mm)

Model	F	N	G	H	NN	GA	HA	I	J	K	KA	NA	M	Z	ZZ
MXQR8-10	25	4	7	25	2	13	19	11	17	23.5	—	4	46	45.5	53
MXQR8-20	25	4	14	28	2	14	28	10	28	33.5	—	4	56	55.5	63
MXQR8-30	26	6	<small>(Note)</small>	<small>(Note)</small>	3	29	27	12	40	43.5	—	4	70	69.5	77
MXQR8-40	32	6	8	31	3	39	31	14	52	53.5	—	4	84	83.5	91
MXQR8-50	46	6	8	29	4	37	58	13	78	63.5	82.5	8	109	108.5	116
MXQR8-75	50	6	31	30	4	61	60	12	105	88.5	112.5	8	135	134.5	142

Note) Refer to the bottom view of the MXQR8-30.



Mounting of adjuster on the left side

* Other dimensions are the same as those for mounting the adjuster on the right side.

- Note 1) If long bolts are used, they can touch the guide block and cause malfunction, etc. Refer to Specific Product Precautions.
 Note 2) Since the table is made of a magnetic substance, it could become magnetized if touched by a magnet, etc. This could cause auto switch malfunction.
 Note 3) Check the procedures and tightening torque when changing the mounting position of the adjuster on site. Otherwise, operation failure, accuracy failure, play and damage can result. For details, refer to the **MXQR Operation Manual**.

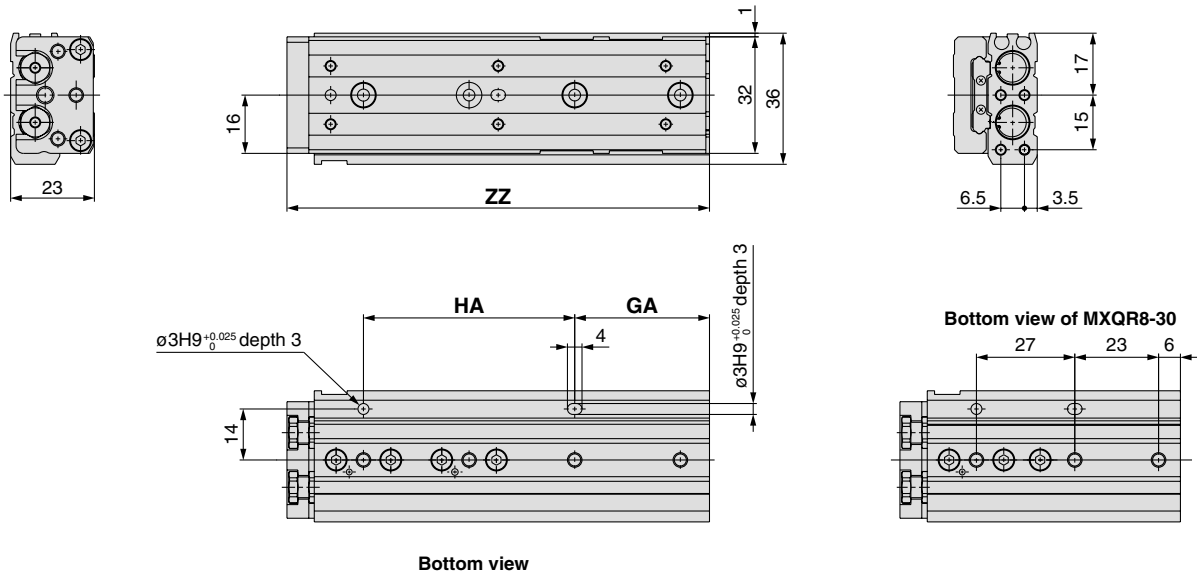

Adjuster Options

With rubber stopper (ø8): MXQR8(L)-□□AS, AT, A

Stroke Adjustable Range (mm)

Extension stroke end	Retraction stroke end
5	5

* Other dimensions are the same as those for mounting the adjuster on the right side.

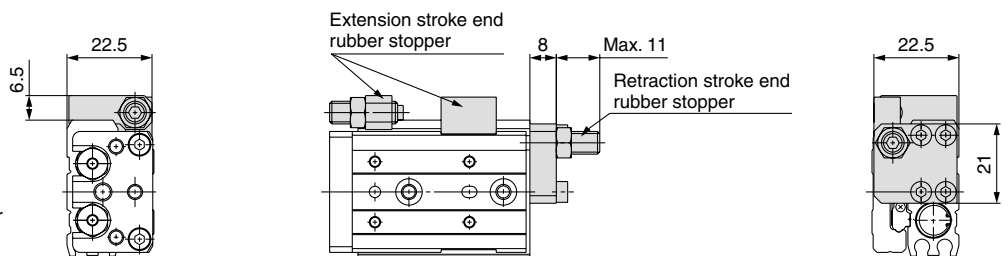

With shock absorber (ø8): MXQR8(L)-□□BS, BT, B, JS, JT, J

Stroke Adjustable Range (mm)

Extension stroke end	Retraction stroke end
20	20

* Other dimensions are the same as those for mounting the adjuster on the right side.

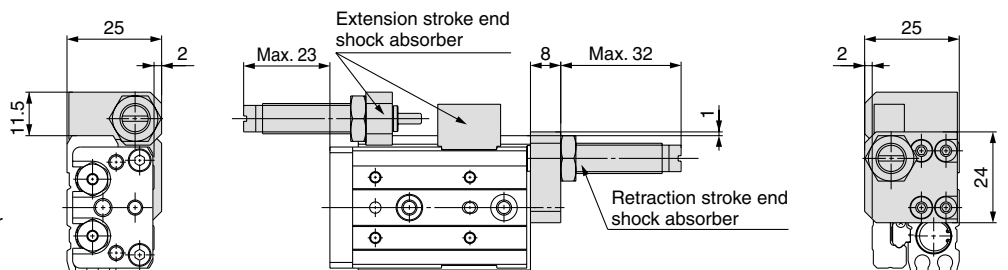

With metal stopper (ø8): MXQR8(L)-□□CS, CT, C

Stroke Adjustable Range (mm)

Extension stroke end	Retraction stroke end
5	5

* Other dimensions are the same as those for mounting the adjuster on the right side.

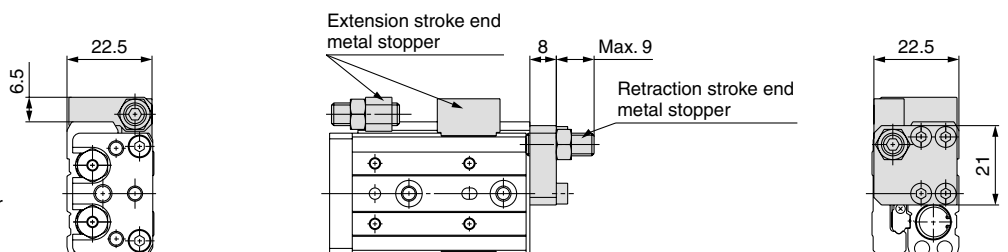

* For detailed dimensions about the stroke adjuster, refer to Adjuster Options.
 Rubber stopper (Refer to pages 20 and 21.)
 Shock absorber (Refer to page 22.)
 Metal stopper (Refer to pages 23 and 24.)

Mounting of adjuster on the right side

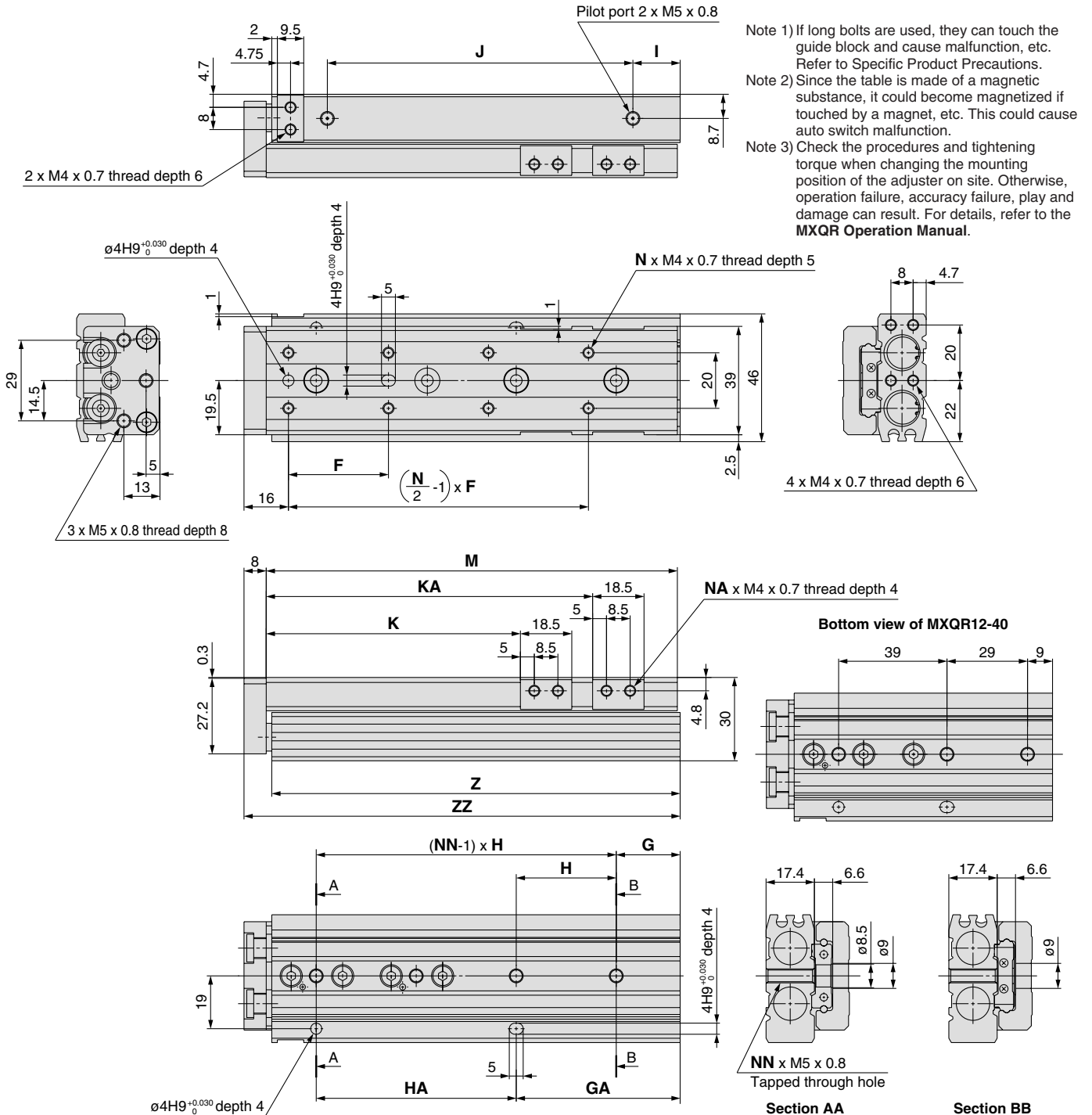

Model	F	N	G	H	NN	GA	HA	I	J	K	KA	NA	M	Z	ZZ
MXQR12- 10	28	4	18	32	2	18	32	12	34	26.5	—	4	67	66	76
MXQR12- 20	28	4	18	32	2	18	32	12	34	36.5	—	4	67	66	76
MXQR12- 30	38	4	20	40	2	20	40	14	42	46.5	—	4	77	76	86
MXQR12- 40	34	6	(Note)	(Note)	3	38	39	15	58	56.5	—	4	94	93	103
MXQR12- 50	34	6	9	39	3	48	39	13	70	66.5	—	4	104	103	113
MXQR12- 75	36	8	23	36	4	59	72	17	110	91.5	117.5	8	148	147	157
MXQR12-100	36	10	12	36	5	84	72	17	135	116.5	142.5	8	173	172	182

Note) Refer to the bottom view of the MXQR12-40.

Mounting of adjuster on the left side

* Other dimensions are the same as those for mounting the adjuster on the right side.

Note 1) If long bolts are used, they can touch the guide block and cause malfunction, etc. Refer to Specific Product Precautions.

Note 2) Since the table is made of a magnetic substance, it could become magnetized if touched by a magnet, etc. This could cause auto switch malfunction.

Note 3) Check the procedures and tightening torque when changing the mounting position of the adjuster on site. Otherwise, operation failure, accuracy failure, play and damage can result. For details, refer to the **MXQR Operation Manual**.

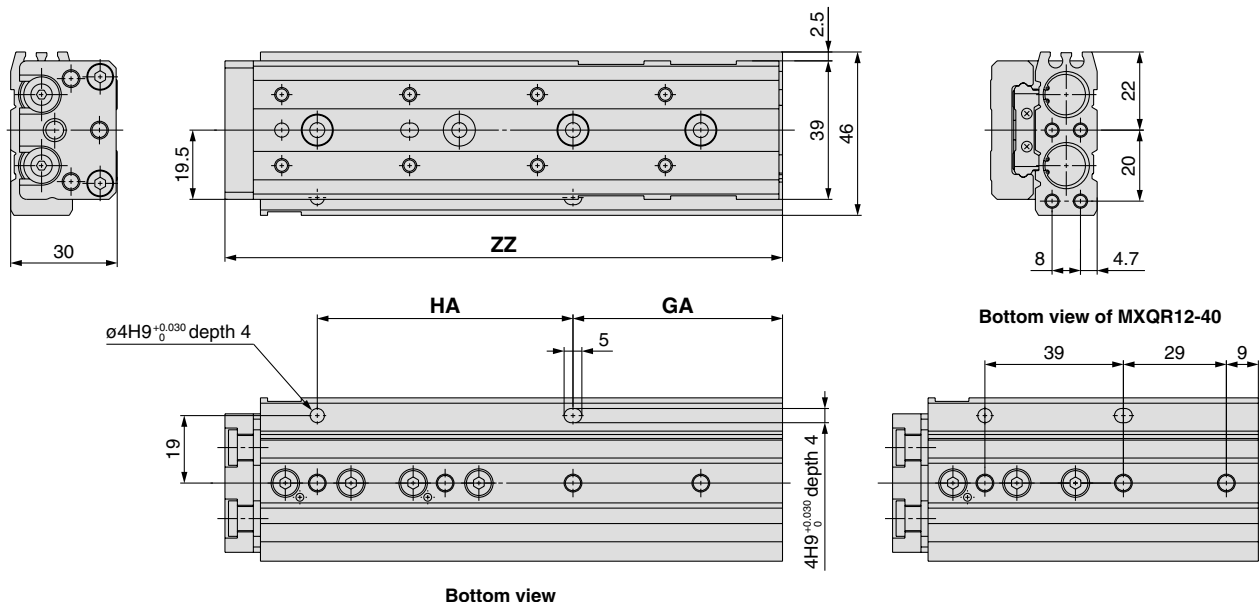

Adjuster Options

With rubber stopper ($\phi 12$): MXQR12(L)-□□AS, AT, A

Stroke Adjustable Range (mm)

Extension stroke end	Retraction stroke end
5	5

* Other dimensions are the same as those for mounting the adjuster on the right side.

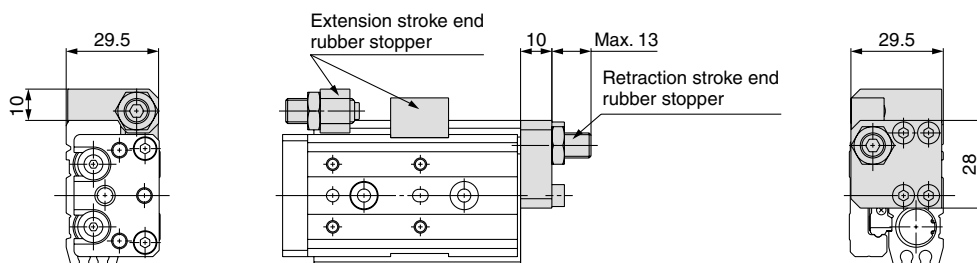

With shock absorber ($\phi 12$): MXQR12(L)-□□BS, BT, B, JS, JT, J

Stroke Adjustable Range (mm)

Extension stroke end	Retraction stroke end
18	18

* Other dimensions are the same as those for mounting the adjuster on the right side.

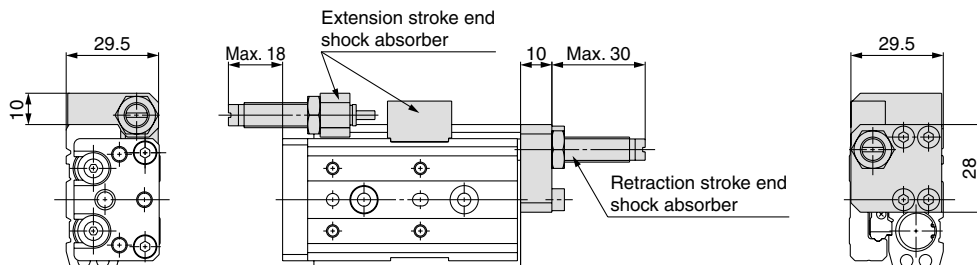

With metal stopper ($\phi 12$): MXQR12(L)-□□CS, CT, C

Stroke Adjustable Range (mm)

Extension stroke end	Retraction stroke end
5	5

* Other dimensions are the same as those for mounting the adjuster on the right side.

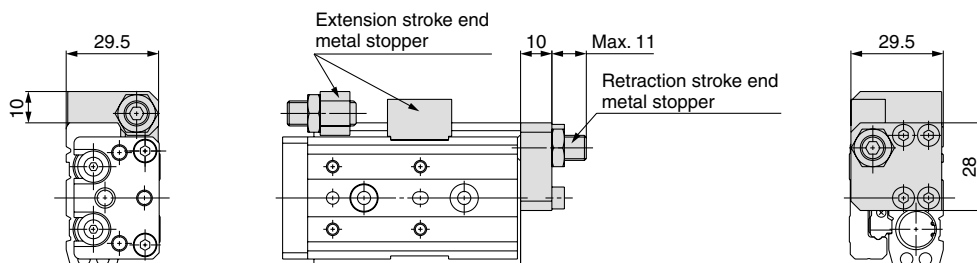

* For detailed dimensions about the stroke adjuster, refer to Adjuster Options.
 Rubber stopper (Refer to pages 20 and 21.)
 Shock absorber (Refer to pages 22.)
 Metal stopper (Refer to pages 23 and 24.)

Mounting of adjuster on the right side

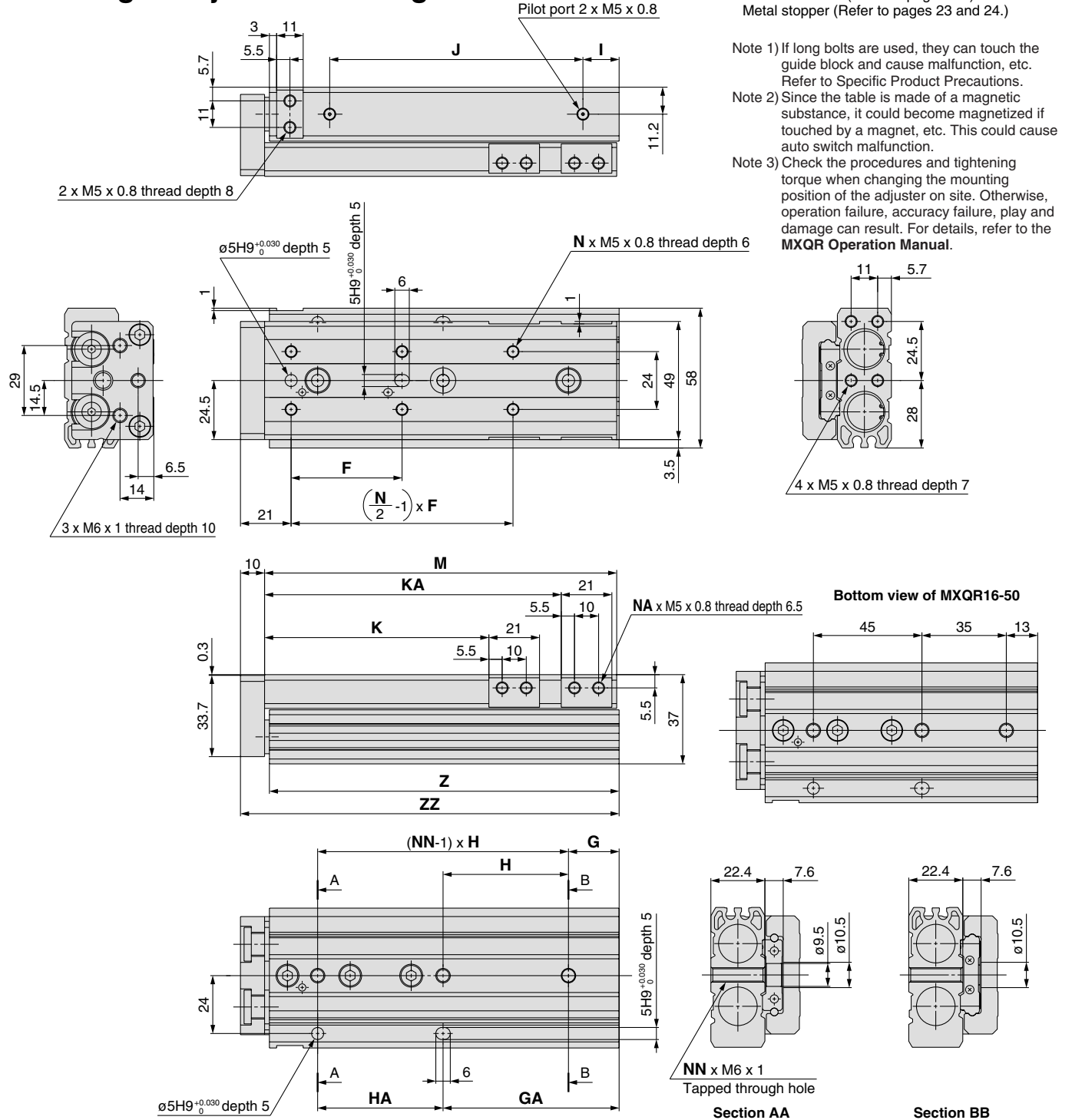

Note 1) If long bolts are used, they can touch the guide block and cause malfunction, etc. Refer to Specific Product Precautions.
 Note 2) Since the table is made of a magnetic substance, it could become magnetized if touched by a magnet, etc. This could cause auto switch malfunction.
 Note 3) Check the procedures and tightening torque when changing the mounting position of the adjuster on site. Otherwise, operation failure, accuracy failure, play and damage can result. For details, refer to the **MXQR Operation Manual**.

Model	F	N	G	H	NN	GA	HA	I	J	K	KA	NA	M	Z	ZZ
MXQR16- 10	38	4	18	39	2	18	39	12	40	28	—	4	78	77	89
MXQR16- 20	38	4	18	39	2	18	39	12	40	38	—	4	78	77	89
MXQR16- 30	48	4	19	48	2	19	48	12	50	48	—	4	88	87	99
MXQR16- 40	58	4	19	58	2	19	58	12	60	58	—	4	98	97	109
MXQR16- 50	40	6	(Note)	(Note)	3	48	45	20	68	68	91	8	114	113	125
MXQR16- 75	46	6	21	52	3	73	52	15	105	93	123	8	146	145	157
MXQR16-100	44	8	36	44	4	80	88	18	145	118	166	8	189	188	200
MXQR16-125	44	10	17	44	5	105	88	23	165	143	191	8	214	213	225

Note) Refer to the bottom view of the MXQR16-50.

Mounting of adjuster on the left side

* Other dimensions are the same as those for mounting the adjuster on the right side.

Note 1) If long bolts are used, they can touch the guide block and cause malfunction, etc. Refer to Specific Product Precautions.

Note 2) Since the table is made of a magnetic substance, it could become magnetized if touched by a magnet, etc. This could cause auto switch malfunction.

Note 3) Check the procedures and tightening torque when changing the mounting position of the adjuster on site. Otherwise, operation failure, accuracy failure, play and damage can result. For details, refer to the **MXQR Operation Manual**.

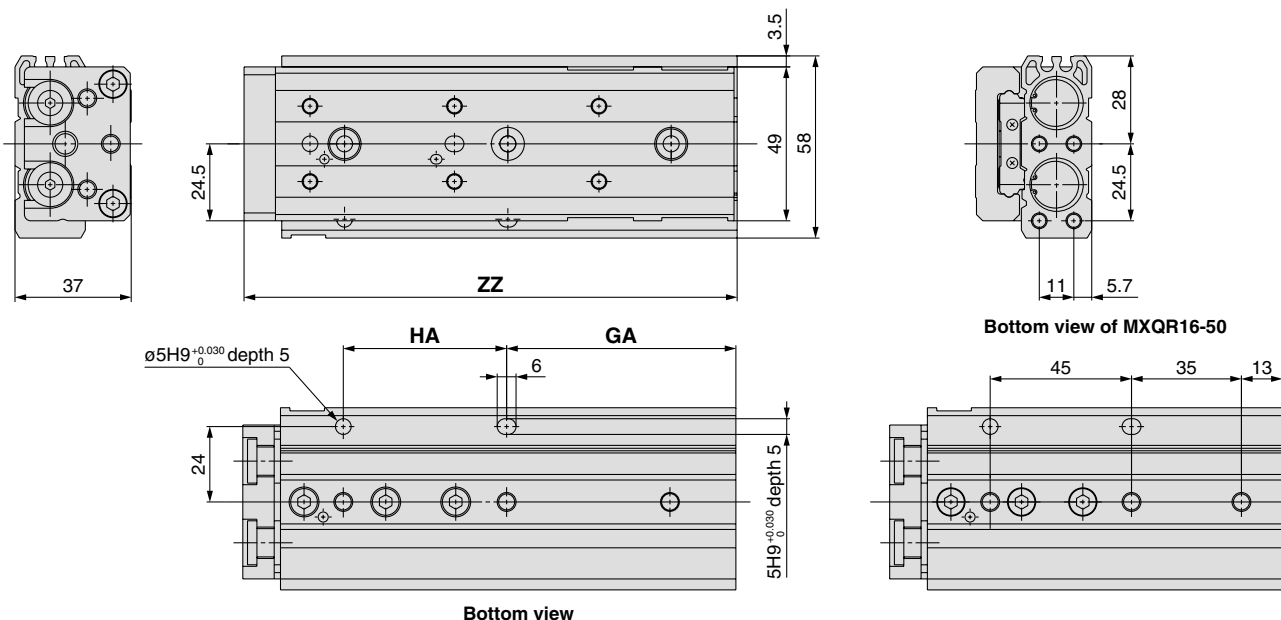

Adjuster Options

With rubber stopper (ø16): MXQR16(L)-□□AS, AT, A

Stroke Adjustable Range (mm)

Extension stroke end	Retraction stroke end
5	5

* Other dimensions are the same as those for mounting the adjuster on the right side.

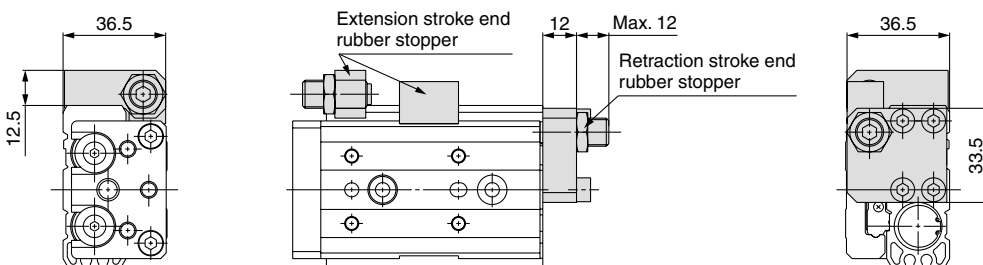

With shock absorber (ø16): MXQR16(L)-□□BS, BT, B, JS, JT, J

Stroke Adjustable Range (mm)

Extension stroke end	Retraction stroke end
22	22

* Other dimensions are the same as those for mounting the adjuster on the right side.

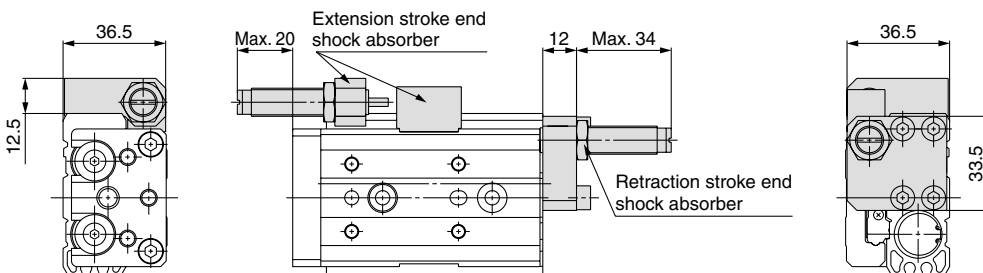

With metal stopper (ø16): MXQR16(L)-□□CS, CT, C

Stroke Adjustable Range (mm)

Extension stroke end	Retraction stroke end
5	5

* Other dimensions are the same as those for mounting the adjuster on the right side.

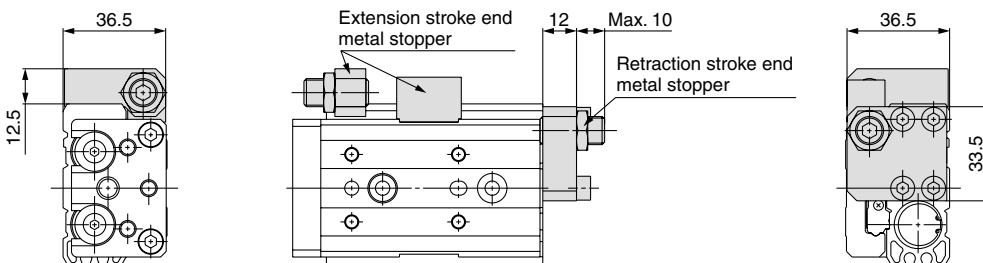

Series MXQR

Dimensions: MXQR 20

Mounting of adjuster on the right side

* For detailed dimensions about the stroke adjuster, refer to Adjuster Options.
 Rubber stopper (Refer to pages 20 and 21.)
 Shock absorber (Refer to page 22.)
 Metal stopper (Refer to pages 23 and 24.)

Note 1) If long bolts are used, they can touch the guide block and cause malfunction, etc. Refer to Specific Product Precautions.
 Note 2) Since the table is made of a magnetic substance, it could become magnetized if touched by a magnet, etc. This could cause auto switch malfunction.
 Note 3) Check the procedures and tightening torque when changing the mounting position of the adjuster on site. Otherwise, operation failure, accuracy failure, play and damage can result. For details, refer to the **MXQR Operation Manual**.

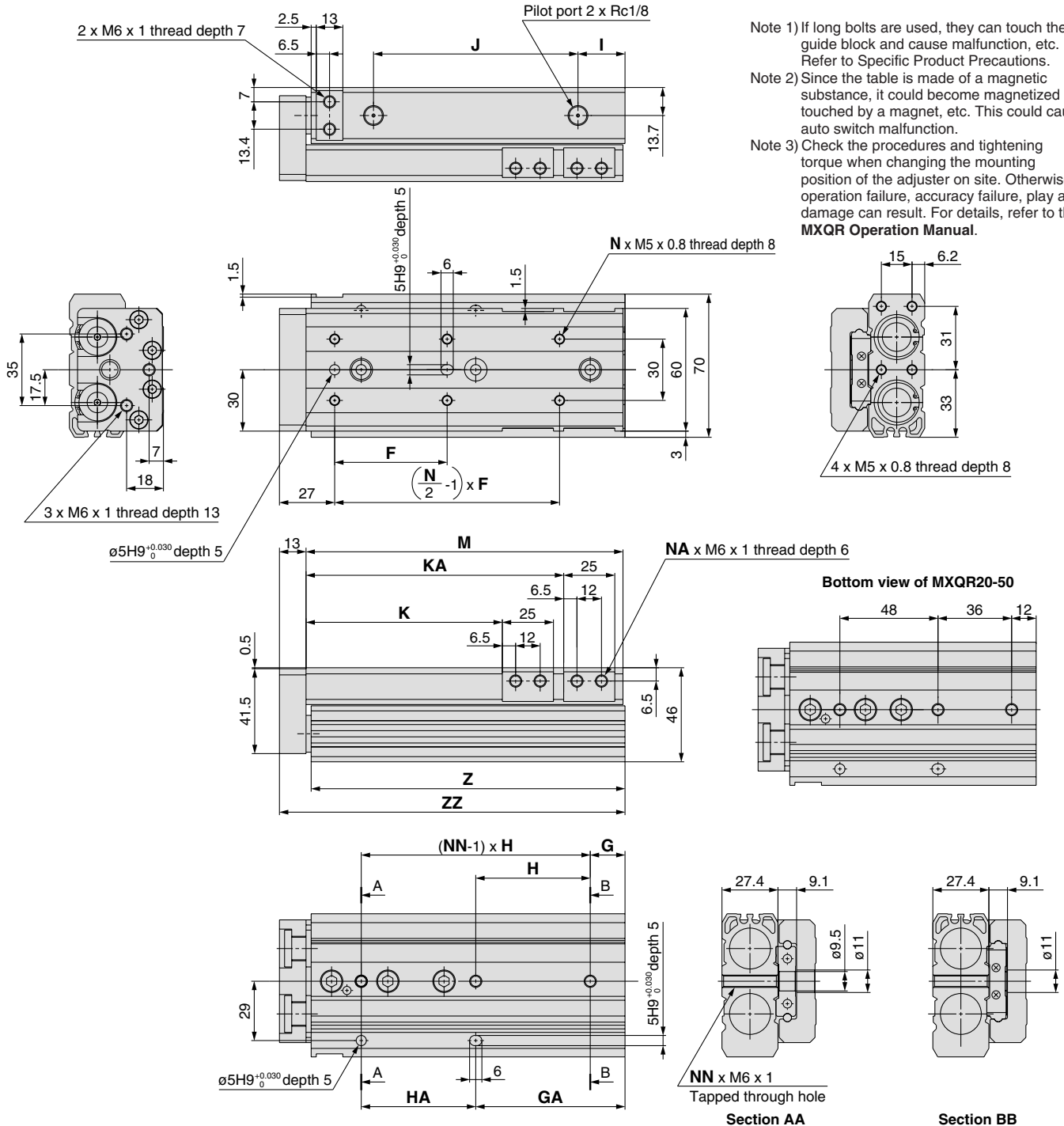

(mm)

Model	F	N	G	H	NN	GA	HA	I	J	K	KA	NA	M	Z	ZZ
MXQR20- 10	45	4	22	46	2	18	50	16	46	31	—	4	94	92.5	108
MXQR20- 20	40	4	22	46	2	18	50	16	46	41	—	4	94	92.5	108
MXQR20- 30	48	4	22	46	2	18	50	16	46	51	—	4	94	92.5	108
MXQR20- 40	58	4	22	56	2	22	56	16	56	61	—	4	104	102.5	118
MXQR20- 50	42	6	Note)	Note)	3	48	48	18	72	71	—	4	122	120.5	136
MXQR20- 75	55	6	17	56	3	73	56	23	100	96	126	8	155	153.5	169
MXQR20-100	50	8	18	56	4	74	112	25	155	121	183	8	212	210.5	226
MXQR20-125	55	8	37	59	4	96	118	18	190	146	211	8	240	238.5	254
MXQR20-150	62	8	56	62	4	118	124	21	215	171	239	8	268	266.5	282

Note) Refer to the bottom view of the MXQR20-50.

Mounting of adjuster on the left side

* Other dimensions are the same as those for mounting the adjuster on the right side.

Note 1) If long bolts are used, they can touch the guide block and cause malfunction, etc. Refer to Specific Product Precautions.

Note 2) Since the table is made of a magnetic substance, it could become magnetized if touched by a magnet, etc. This could cause auto switch malfunction.

Note 3) Check the procedures and tightening torque when changing the mounting position of the adjuster on site. Otherwise, operation failure, accuracy failure, play and damage can result. For details, refer to the **MXQR Operation Manual**.

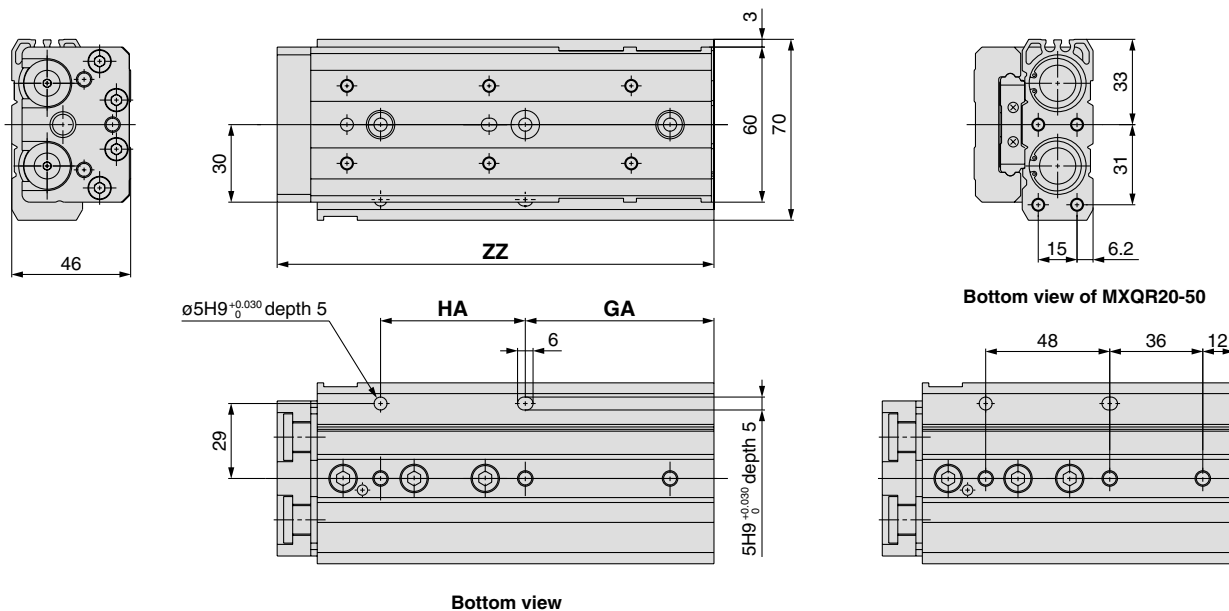

Adjuster Options

With rubber stopper (ø20): MXQR20(L)-□□AS, AT, A

Stroke Adjustable Range (mm)

Extension stroke end	Retraction stroke end
5	5

* Other dimensions are the same as those for mounting the adjuster on the right side.

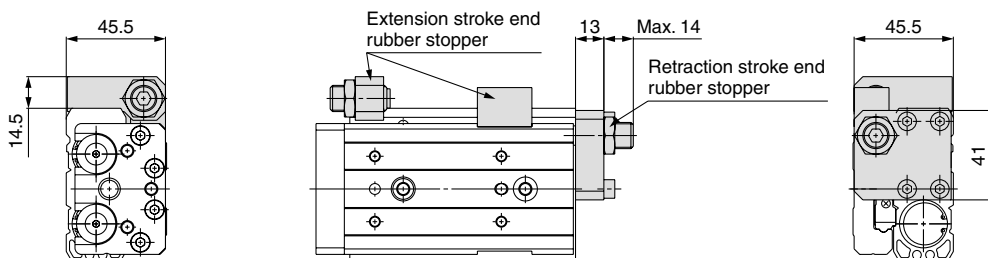

With shock absorber (ø20): MXQR20(L)-□□BS, BT, B, JS, JT, J

Stroke Adjustable Range (mm)

Extension stroke end	Retraction stroke end
35	35

* Other dimensions are the same as those for mounting the adjuster on the right side.

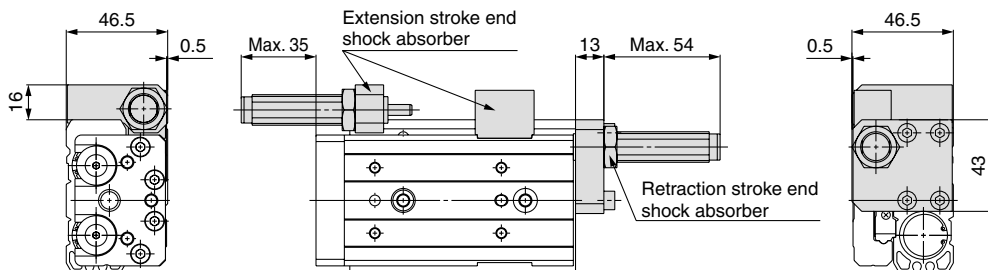

With metal stopper (ø20): MXQR20(L)-□□CS, CT, C

Stroke Adjustable Range (mm)

Extension stroke end	Retraction stroke end
5	5

* Other dimensions are the same as those for mounting the adjuster on the right side.

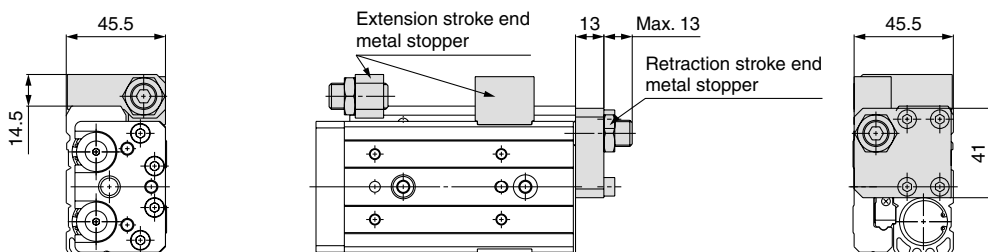

Series MXQR

Dimensions: MXQR 25

* For detailed dimensions about the stroke adjuster, refer to Adjuster Options.
 Rubber stopper (Refer to pages 20 and 21.)
 Shock absorber (Refer to page 22.)
 Metal stopper (Refer to pages 23 and 24.)

Mounting of adjuster on the right side

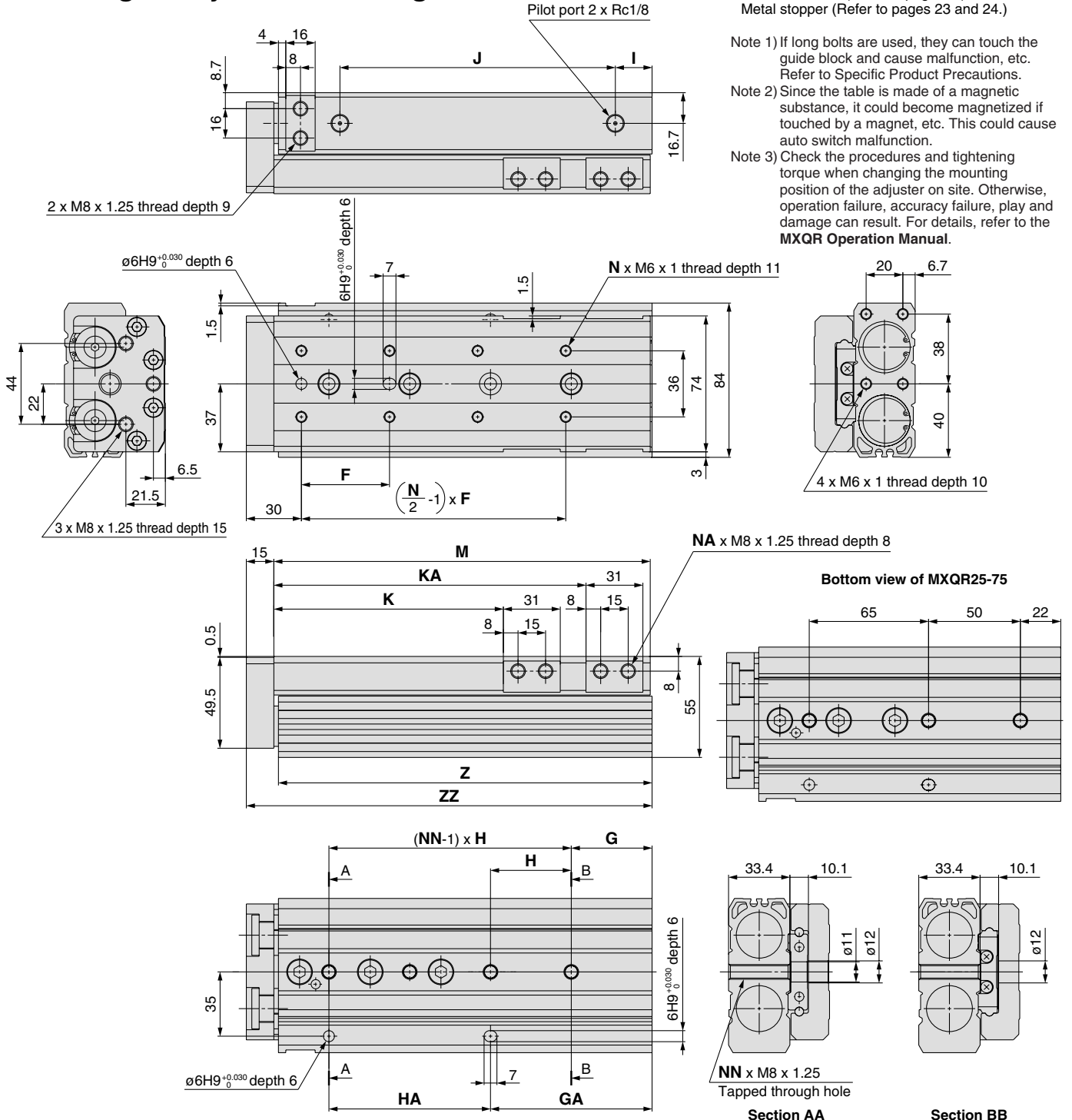

Note 1) If long bolts are used, they can touch the guide block and cause malfunction, etc. Refer to Specific Product Precautions.
 Note 2) Since the table is made of a magnetic substance, it could become magnetized if touched by a magnet, etc. This could cause auto switch malfunction.
 Note 3) Check the procedures and tightening torque when changing the mounting position of the adjuster on site. Otherwise, operation failure, accuracy failure, play and damage can result. For details, refer to the MXQR Operation Manual.

Model	F	N	G	H	NN	GA	HA	I	J	K	KA	NA	M	Z	ZZ
MXQR25- 10	55	4	23	55	2	23	55	16	56	35	—	4	107	105.5	123
MXQR25- 20	46	4	23	55	2	23	55	16	56	45	—	4	107	105.5	123
MXQR25- 30	55	4	23	55	2	23	55	16	56	55	—	4	107	105.5	123
MXQR25- 40	65	4	23	65	2	23	65	16	66	65	—	4	117	115.5	133
MXQR25- 50	75	4	32	80	2	32	80	16	90	75	—	4	141	139.5	157
MXQR25- 75	60	6	Note)	Note)	3	72	65	31	100	100	—	4	166	164.5	182
MXQR25-100	48	8	44	44	4	88	88	20	150	125	170	8	205	203.5	221
MXQR25-125	60	8	31	66	4	97	132	18	205	150	223	8	258	256.5	274
MXQR25-150	65	8	56	66	4	122	132	18	230	175	248	8	283	281.5	299

Note) Refer to the bottom view of the MXQR25-75.



Mounting of adjuster on the left side

* Other dimensions are the same as those for mounting the adjuster on the right side.

Note 1) If long bolts are used, they can touch the guide block and cause malfunction, etc. Refer to Specific Product Precautions.

Note 2) Since the table is made of a magnetic substance, it could become magnetized if touched by a magnet, etc. This could cause auto switch malfunction.

Note 3) Check the procedures and tightening torque when changing the mounting position of the adjuster on site. Otherwise, operation failure, accuracy failure, play and damage can result. For details, refer to the **MXQR Operation Manual**.

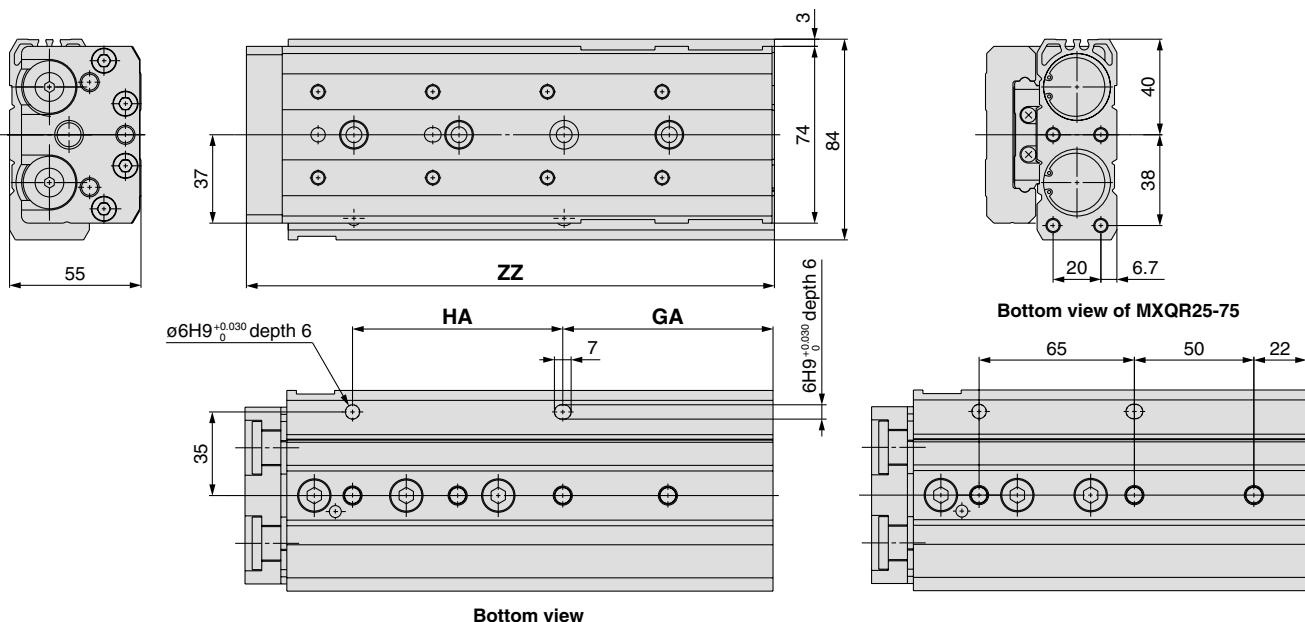

Adjuster Options

With rubber stopper (ø25): MXQR25(L)-□□AS, AT, A

Stroke Adjustable Range (mm)

Extension stroke end	Retraction stroke end
5	5

* Other dimensions are the same as those for mounting the adjuster on the right side.

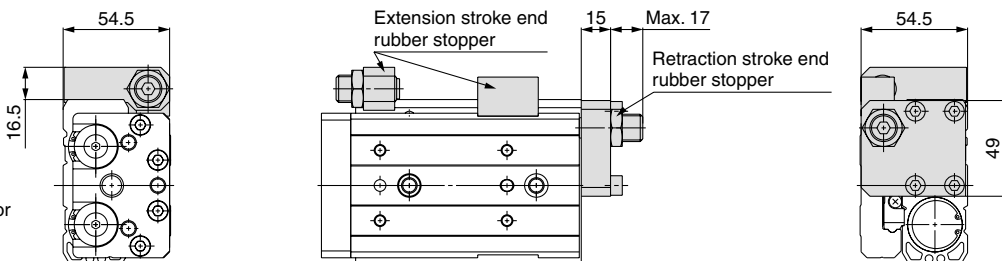

With shock absorber (ø25): MXQR25(L)-□□BS, BT, B, JS, JT, J

Stroke Adjustable Range (mm)

Extension stroke end	Retraction stroke end
35	35

* Other dimensions are the same as those for mounting the adjuster on the right side.

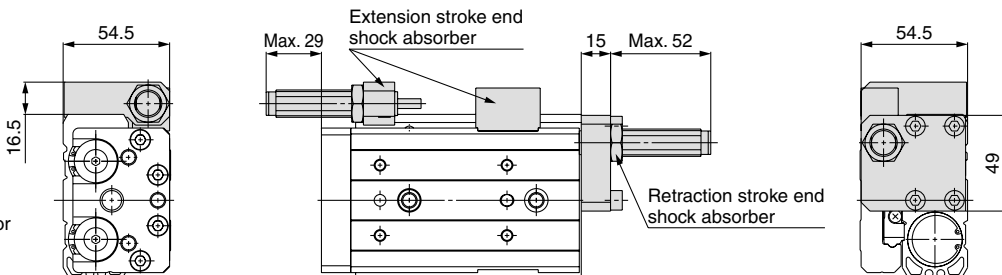

With metal stopper (ø25): MXQR25(L)-□□CS, CT, C

Stroke Adjustable Range (mm)

Extension stroke end	Retraction stroke end
5	5

* Other dimensions are the same as those for mounting the adjuster on the right side.

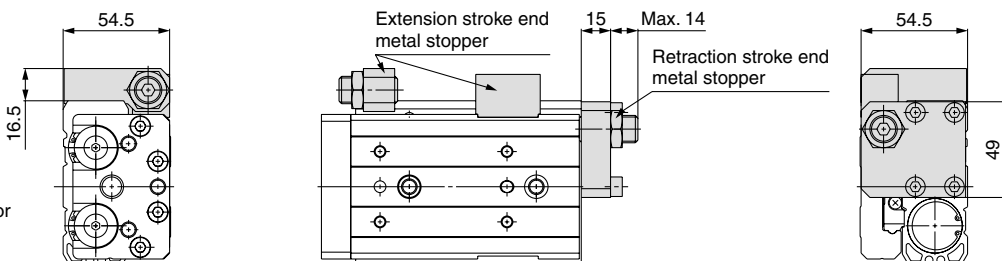

Series MXQR

Dimensions: Adjuster

Rubber stopper (AS, AT)

Extension stroke end

Body mounting parts

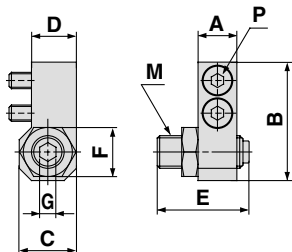
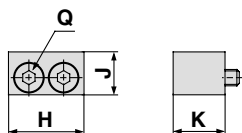

Table mounting parts



Applicable size	Model	Stroke adjustment range (mm)	Body mounting parts								Table mounting parts				
			A	B	C	D	E	F	G	M	P ^{*1)}	H	J	K	Q ^{*1)}
MXQR 6	MXQR-AS 6	5	6	19	8	7	16.5	7	2.5	M5 x 0.8	M2.5 x 6	12.5	6	8.3	M2.5 x 8
	MXQR-AS 6-X11	15													
MXQR 8	MXQR-AS 8	5	7	22	9	7.5	19.5	8	3	M6 x 1	M3 x 8	14.6	7	9.8	M3 x 10
	MXQR-AS 8-X11	15					29.5								
	MXQR-AS 8-X12	25					39.5								
MXQR12	MXQR-AS12	5	9.5	29	14	11	23.5	12	4	M8 x 1	M4 x 12	18.5	10.5	12.7	M4 x 12
	MXQR-AS12-X11	15					33.5								
	MXQR-AS12-X12	25					43.5								
MXQR16	MXQR-AS16	5	11	36	17	13.5	24.5	14	5	M10 x 1	M5 x 16	21	13	15	M5 x 16
	MXQR-AS16-X11	15					34.5								
	MXQR-AS16-X12	25					44.5								
MXQR20	MXQR-AS20	5	13	45	20	16	27.5	17	6	M12 x 1.25	M6 x 16	25	16	18	M6 x 16
	MXQR-AS20-X11	15					37.5								
	MXQR-AS20-X12	25					47.5								
MXQR25	MXQR-AS25	5	16	54	22	18	32.5	19	6	M14 x 1.5	M8 x 18	31	17	20	M8 x 18
	MXQR-AS25-X11	15					42.5								
	MXQR-AS25-X12	25					52.5								

*1) Size of hexagon socket head bolt

*2) Mounting the adjuster on the left side is also available. For "How to Order", refer to page 3.

The outer dimensions are the same as those for mounting the adjuster on the right side.

Retraction stroke end

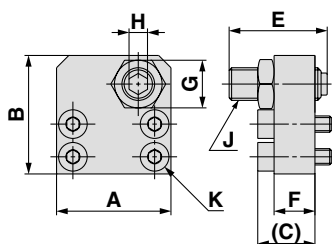

Applicable size	Model	Stroke adjustment range (mm)	A	B	C	E	F	G	H	J	K ^{*1)}
MXQR 6	MXQR-AT 6	5	17.5	19	8.5	16.5	6	7	2.5	M5 x 0.8	M2.5 x 9
	MXQR-AT 6-X11	15				26.5					
MXQR 8	MXQR-AT 8	5	21	22	11	19.5	8	8	3	M6 x 1	M3 x 11
	MXQR-AT 8-X11	15				29.5					
	MXQR-AT 8-X12	25				39.5					
MXQR12	MXQR-AT12	5	28	29	14	23.5	10	12	4	M8 x 1	M4 x 14
	MXQR-AT12-X11	15				33.5					
	MXQR-AT12-X12	25				43.5					
MXQR16	MXQR-AT16	5	33.5	35.5	17	24.5	12	14	5	M10 x 1	M5 x 18
	MXQR-AT16-X11	15				34.5					
	MXQR-AT16-X12	25				44.5					
MXQR20	MXQR-AT20	5	41	44.5	18	27.5	13	17	6	M12 x 1.25	M5 x 18
	MXQR-AT20-X11	15				37.5					
	MXQR-AT20-X12	25				47.5					
MXQR25	MXQR-AT25	5	49	53.5	21	32.5	15	19	6	M14 x 1.5	M6 x 22
	MXQR-AT25-X11	15				42.5					
	MXQR-AT25-X12	25				52.5					

*1) Size of hexagon socket head bolt

*2) Mounting the adjuster on the left side is also available. For "How to Order", refer to page 3.

The outer dimensions are the same as those for mounting the adjuster on the right side.

Caution for Adjuster Options

⚠ Caution

1. Do not replace with the bolt other than the original adjustment bolt. This could result in looseness and damage due to impact forces, etc.

2. Follow the table on the right for tightening torque of lock nuts. Insufficient torque will cause a decrease in the positioning accuracy.

Model	Tightening torque (N·m)
MXQR 6	3.0
MXQR 8	5.0
MXQR12	12.5
MXQR16	25.0
MXQR20	43.0
MXQR25	69.0

3. When stroke adjuster is adjusted, do not hit the table with the wrench. This could result in looseness.

Refer to the MXQR Operation Manual for details.

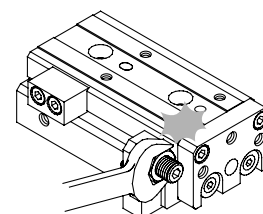

Dimensions: Adjustment Bolt/Rubber Stopper

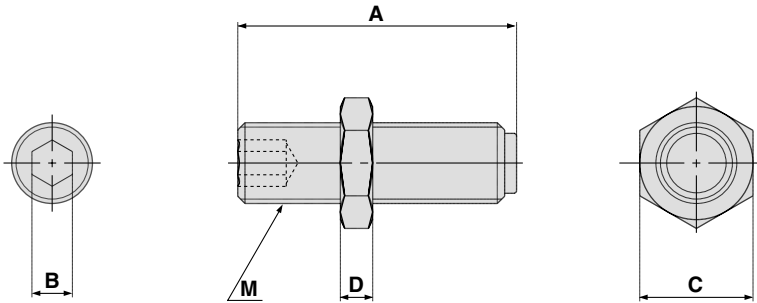

Applicable size	Model	Stroke adjustment range (mm)	A	B	C	D	M
MXQR 6	MXQ-A627	5	16.5	2.5	7	3	M5 x 0.8
	MXQ-A627-X11	15	26.5				
MXQR 8	MXQ-A827	5	19.5	3	8	3.5	M6 x 1
	MXQ-A827-X11	15	29.5				
	MXQ-A827-X12	25	39.5				
MXQR12	MXQ-A1227	5	23.5	4	12	4	M8 x 1
	MXQ-A1227-X11	15	33.5				
	MXQ-A1227-X12	25	43.5				
MXQR16	MXQ-A1627	5	24.5	5	14	4	M10 x 1
	MXQ-A1627-X11	15	34.5				
	MXQ-A1627-X12	25	44.5				
MXQR20	MXQ-A2027	5	27.5	6	17	5	M12 x 1.25
	MXQ-A2027-X11	15	37.5				
	MXQ-A2027-X12	25	47.5				
MXQR25	MXQ-A2527	5	32.5	6	19	6	M14 x 1.5
	MXQ-A2527-X11	15	42.5				
	MXQ-A2527-X12	25	52.5				

How to Order Adjustment Bolt/Rubber Stopper

MXQ - A 12 27 - X11

Applicable bore size ●

6	ø6
8	ø8
12	ø12
16	ø16
20	ø20
25	ø25

● Adjustment range

Nil	5 mm
-X11	15 mm
-X12	25 mm

- * -X12 (adjustment range: 25 mm) is not available with the MXQR6 series.
- * For dimensions, refer to the above figure.
- * Mounting the adjuster on the left side is also the same.
- * Common with the MXQ series.

Series MXQR

Dimensions: Adjuster

Shock absorber (BS, JS, BT, JT)

Extension stroke end

Body mounting parts

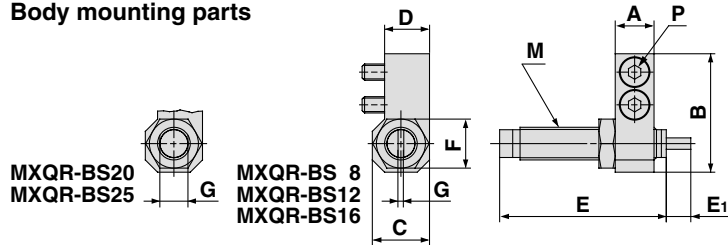
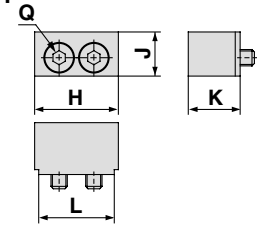

Table mounting parts



Applicable size	Model	Stroke adjustment range (mm)	Body mounting parts										Table mounting parts				
			A	B	C	D	E	E ₁	F	G	M	P ^{*1)}	H	J	K	L	Q ^{*1)}
MXQR 6	MXQR-BS6	12	6	19	9	8	28.5	4	8	1	M6 x 0.75	M2.5 x 6	14.5	7	8.3	12.5	M2.5 x 8
MXQR 8	MXQR-BS8	20	7	24.5	14	12.5	40.8	5	12	1.4	M8 x 1	M3 x 12	16.6	8	12	14.6	M3 x 12
	MXQR-JS8																
MXQR12	MXQR-BS12	18	9.5	29	14	11	40.8	6	12	1.4	M8 x 1	M4 x 12	20.5	11	13	18.5	M4 x 12
	MXQR-JS12																
MXQR16	MXQR-BS16	22	11	36	17	13.5	46.7	7	14	1.4	M10 x 1	M5 x 16	23	13.5	16	21	M5 x 16
	MXQR-JS16																
MXQR20	MXQR-BS20	35	13	46	22	17.5	67.3	11	19	12	M14 x 1.5	M6 x 18	27	17	22	25	M6 x 20
	MXQR-JS20																
MXQR25	MXQR-BS25	35	16	54	22	18	67.3	12	19	12	M14 x 1.5	M8 x 18	33	19	22	31	M8 x 20
	MXQR-JS25																

*1) Size of hexagon socket head bolt *2) Mounting the adjuster on the left side is also available. For "How to Order", refer to page 3. The outer dimensions are the same as those for mounting the adjuster on the right side.

Retraction stroke end

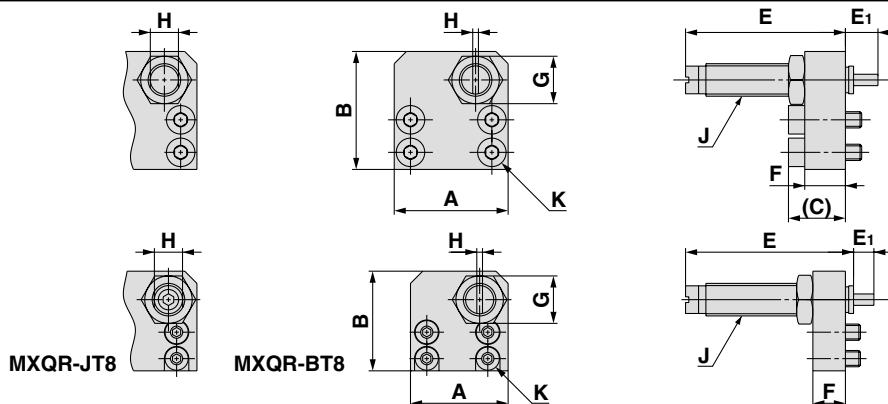

Applicable size	Model	Stroke adjustment range (mm)	A	B	C	E	E ₁	F	G	H	J	K ^{*1)}
MXQR 6	MXQR-BT6	12	18	19	8.5	28.5	4	6	8	1	M6 x 0.75	M2.5 x 9
MXQR 8	MXQR-BT8	20	24	24.5	—	40.8	5	8	12	1.4	M8 x 1	M3 x 11
	MXQR-JT8											
MXQR12	MXQR-BT12	18	28	29	14	40.8	6	10	12	1.4	M8 x 1	M4 x 14
	MXQR-JT12											
MXQR16	MXQR-BT16	22	33.5	35.5	17	46.7	7	12	14	1.4	M10 x 1	M5 x 18
	MXQR-JT16											
MXQR20	MXQR-BT20	35	43	46	18	67.3	11	13	19	12	M14 x 1.5	M5 x 18
	MXQR-JT20											
MXQR25	MXQR-BT25	35	49	53.5	21	67.3	12	15	19	12	M14 x 1.5	M6 x 22
	MXQR-JT25											

*1) Size of hexagon socket head bolt
*2) Mounting the adjuster on the left side is also available. For "How to Order", refer to page 3. The outer dimensions are the same as those for mounting the adjuster on the right side.

Caution for Adjuster Options

⚠ Caution

- Follow the table on the right for lock nut tightening torque of shock absorber.
- For the details of handling the shock absorber, refer to the catalog and Operation Manual of the shock absorber.

Model	Tightening torque (N·m)	Model	Tightening torque (N·m)
MXQR 6	0.85	MXQR16	3.14
MXQR 8	1.67	MXQR20	10.8
MXQR12		MXQR25	

Dimensions: Adjuster

Metal stopper (CS, CT)

Extension stroke end

Body mounting parts

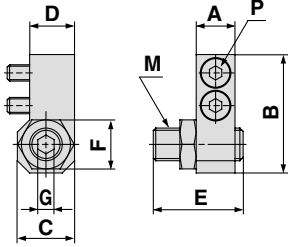
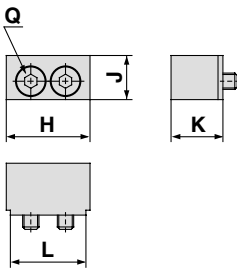

Table mounting parts



Applicable size	Model	Stroke adjustment range (mm)	Body mounting parts										Table mounting parts				
			A	B	C	D	E	F	G	M	P ^{*1)}	H	J	K	L	Q ^{*1)}	
MXQR 6	MXQR-CS 6	5	6	19	8	7	15.5	7	2.5	M5 x 0.8	M2.5 x 6	14.5	7	8.3	12.5	M2.5 x 8	
	MXQR-CS 6-X11	15					25.5										
MXQR 8	MXQR-CS 8	5	7	22	9	7.5	18	8	3	M6 x 1	M3 x 8	16.6	8	9.8	14.6	M3 x 10	
	MXQR-CS 8-X11	15					28										
	MXQR-CS 8-X12	25					38										
MXQR12	MXQR-CS12	5	9.5	29	14	11	22	12	4	M8 x 1	M4 x 12	20.5	11	13	18.5	M4 x 12	
	MXQR-CS12-X11	15					32										
	MXQR-CS12-X12	25					42										
MXQR16	MXQR-CS16	5	11	36	17	13.5	23	14	5	M10 x 1	M5 x 16	23	13.5	16	21	M5 x 16	
	MXQR-CS16-X11	15					33										
	MXQR-CS16-X12	25					43										
MXQR20	MXQR-CS20	5	13	45	20	16	27	17	6	M12 x 1.25	M6 x 16	27	17	22	25	M6 x 20	
	MXQR-CS20-X11	15					37										
	MXQR-CS20-X12	25					47										
MXQR25	MXQR-CS25	5	16	54	22	18	30	19	6	M14 x 1.5	M8 x 18	33	19	22	31	M8 x 20	
	MXQR-CS25-X11	15					40										
	MXQR-CS25-X12	25					50										

*1) Size of hexagon socket head bolt

*2) Mounting the adjuster on the left side is also available. For "How to Order", refer to page 3.

The outer dimensions are the same as those for mounting the adjuster on the right side.

Retraction stroke end

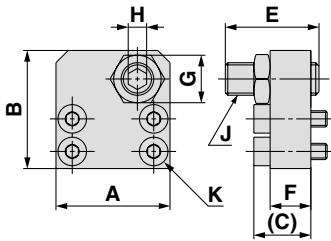

Applicable size	Model	Stroke adjustment range (mm)	A	B	C	E	F	G	H	J	K ^{*1)}
MXQR 6	MXQR-CT 6	5	17.5	19	8.5	15.5	6	7	2.5	M5 x 0.8	M2.5 x 9
	MXQR-CT 6-X11	15				25.5					
MXQR 8	MXQR-CT 8	5	21	22	11	18	8	8	3	M6 x 1	M3 x 11
	MXQR-CT 8-X11	15				28					
	MXQR-CT 8-X12	25				38					
MXQR12	MXQR-CT12	5	28	29	14	22	10	12	4	M8 x 1	M4 x 14
	MXQR-CT12-X11	15				32					
	MXQR-CT12-X12	25				42					
MXQR16	MXQR-CT16	5	33.5	35.5	17	23	12	14	5	M10 x 1	M5 x 18
	MXQR-CT16-X11	15				33					
	MXQR-CT16-X12	25				43					
MXQR20	MXQR-CT20	5	41	44.5	18	27	13	17	6	M12 x 1.25	M5 x 18
	MXQR-CT20-X11	15				37					
	MXQR-CT20-X12	25				47					
MXQR25	MXQR-CT25	5	49	53.5	21	30	15	19	6	M14 x 1.5	M6 x 22
	MXQR-CT25-X11	15				40					
	MXQR-CT25-X12	25				50					

*1) Size of hexagon socket head bolt

*2) Mounting the adjuster on the left side is also available. For "How to Order", refer to page 3.

The outer dimensions are the same as those for mounting the adjuster on the right side.

Series MXQR

Dimensions: Adjustment Bolt/Metal Stopper

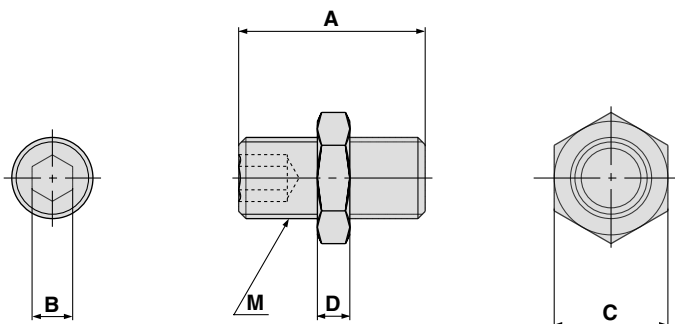

Applicable size	Model	Stroke adjustment range (mm)	A	B	C	D	M
MXQR 6	MXQ-A638	5	15.5	2.5	7	3	M5 x 0.8
	MXQ-A638-X11	15	25.5				
MXQR 8	MXQ-A838	5	18	3	8	3.5	M6 x 1
	MXQ-A838-X11	15	28				
	MXQ-A838-X12	25	38				
MXQR12	MXQ-A1238	5	22	4	12	4	M8 x 1
	MXQ-A1238-X11	15	32				
	MXQ-A1238-X12	25	42				
MXQR16	MXQ-A1638	5	23	5	14	4	M10 x 1
	MXQ-A1638-X11	15	33				
	MXQ-A1638-X12	25	43				
MXQR20	MXQ-A2038	5	27	6	17	5	M12 x 1.25
	MXQ-A2038-X11	15	37				
	MXQ-A2038-X12	25	47				
MXQR25	MXQ-A2538	5	30	6	19	6	M14 x 1.5
	MXQ-A2538-X11	15	40				
	MXQ-A2538-X12	25	50				

How to Order Adjustment Bolt/Metal Stopper

MXQ - A 12 38 - X11

Applicable bore size

6	ø6
8	ø8
12	ø12
16	ø16
20	ø20
25	ø25

Adjustment range

Nil	5 mm
-X11	15 mm
-X12	25 mm

- * -X12 (adjustment range: 25 mm) is not available with the MXQR6 series.
- * For dimensions, refer to the above figure.
- * Mounting the adjuster on the left side is also the same.
- * Common with the MXQ series.

Construction

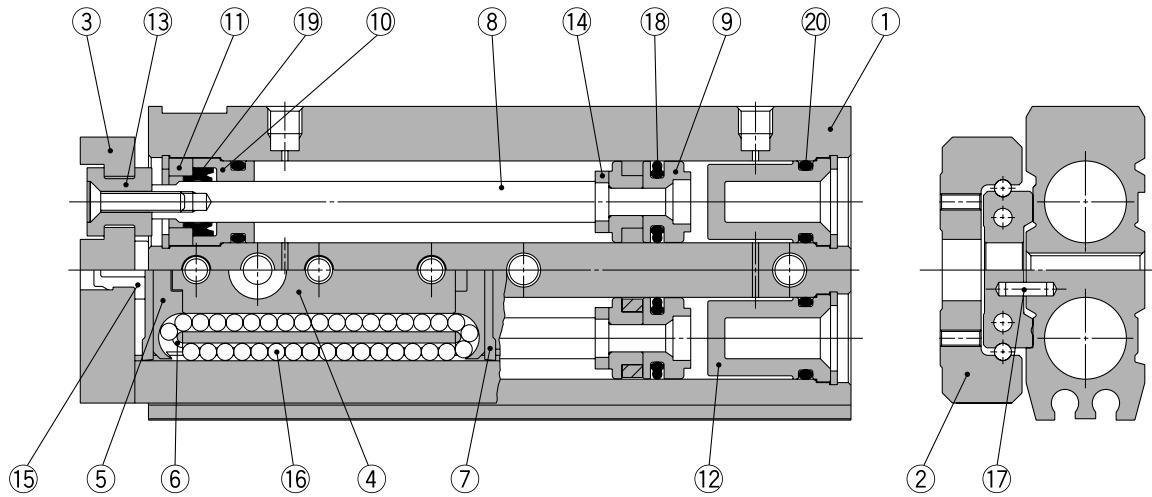

Component Parts

No.	Description	Material	Note
1	Body	Aluminum alloy	Hard anodized
2	Table	Stainless steel	Heat treated
3	End plate	Aluminum alloy	Hard anodized
4	Guide block	Stainless steel	Heat treated
5	Cover	Synthetic resin	
6	Return guide	Synthetic resin	
7	Scraper	Stainless steel, NBR	
8	Rod	Stainless steel	
9	Piston assembly	—	With magnet on single side
10	Rod cover	Aluminum alloy	Anodized
11	Seal support	Brass	Electroless nickel plated
12	Head cap	Synthetic resin	
13	Floating bushing	Stainless steel	
14	Rod bumper	Polyurethane	
15	End bumper	Polyurethane	
16	Steel ball	High carbon chrome bearing steel	
17	Spring pin	Stainless steel	
18	Piston seal	NBR	
19	Rod seal	NBR	
20	O-ring	NBR	

Replacement Parts/Seal Kit

Bore size (mm)	Kit no.	Contents
6	MXQ 6-PS	Set of nos. above ⑱ to ⑳ (1 set)
8	MXQ 8-PS	
12	MXQ12-PS	
16	MXQ16-PS	
20	MXQ20-PS	
25	MXQ25-PS	



* Seal kit includes these seals to provide as a set.
Order the seal kit, based on each bore size.

Replacement Parts/Grease Pack

Applied part	Grease pack part no.
Guide unit	GR-S-010 (10 g)
	GR-S-020 (20 g)
Cylinder unit	GR-L-005 (5 g)
	GR-L-010 (10 g)

Series MXQR

Auto Switch Proper Mounting Position (Detection at Stroke End)

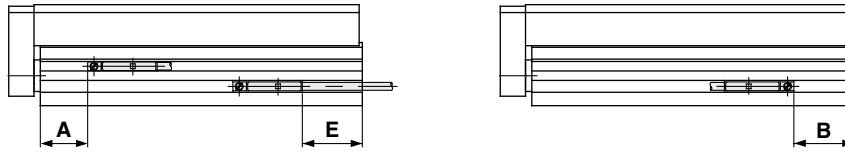

Solid State Auto Switch: D-M9B, D-M9N, D-M9P, D-M9BW, D-M9NW, D-M9PW, D-M9□A

Model	A	B										E										E (D-M9□A)									
		Stroke										Stroke										Stroke									
		10	20	30	40	50	75	100	125	150	10	20	30	40	50	75	100	125	150	10	20	30	40	50	75	100	125	150			
MXQR6	10	9.5	9.5	9.5	17.5	17.5	—	—	—	—	-0.5	-0.5	-0.5	7.5	7.5	—	—	—	—	-2.5	-2.5	-2.5	5.5	5.5	—	—	—	—			
MXQR8	11.5	12	12	16	20	35	36	—	—	—	2	2	6	10	25	26	—	—	—	0	0	4	8	23	24	—	—	—			
MXQR12	15.5	28.5	18.5	18.5	25.5	25.5	44.5	44.5	—	—	18.5	8.5	8.5	15.5	15.5	34.5	34.5	—	—	16.5	6.5	6.5	13.5	13.5	32.5	32.5	—	—			
MXQR16	20.5	34.5	24.5	24.5	24.5	30.5	37.5	55.5	55.5	—	24.5	14.5	14.5	14.5	20.5	27.5	45.5	45.5	—	22.5	12.5	12.5	12.5	18.5	25.5	43.5	43.5	—			
MXQR20	23	47.5	37.5	27.5	37.5	35.5	43.5	75.5	78.5	81.5	37.5	27.5	17.5	27.5	25.5	33.5	65.5	68.5	73.5	35.5	25.5	15.5	25.5	23.5	31.5	63.5	66.5	71.5			
MXQR25	27	56.5	46.5	36.5	36.5	50.5	50.5	64.5	92.5	92.5	46.5	36.5	26.5	26.5	40.5	40.5	54.5	82.5	73.5	44.5	34.5	24.5	24.5	38.5	38.5	52.5	80.5	71.5			

Solid State Auto Switch: D-M9BV, D-M9NV, D-M9PV, D-M9BWV, D-M9NWV, D-M9PWV, D-M9□AV

Model	A	B										E										E (D-M9□AV)									
		Stroke										Stroke										Stroke									
		10	20	30	40	50	75	100	125	150	10	20	30	40	50	75	100	125	150	10	20	30	40	50	75	100	125	150			
MXQR6	10	9.5	9.5	9.5	17.5	17.5	—	—	—	—	1.5	1.5	1.5	9.5	9.5	—	—	—	—	-0.5	-0.5	-0.5	7.5	7.5	—	—	—	—			
MXQR8	11.5	12	12	16	20	35	36	—	—	—	4	4	8	12	27	28	—	—	—	2	2	6	10	25	26	—	—	—			
MXQR12	15.5	28.5	18.5	18.5	25.5	25.5	44.5	44.5	—	—	20.5	10.5	10.5	17.5	17.5	36.5	36.5	—	—	18.5	8.5	8.5	15.5	15.5	34.5	34.5	—	—			
MXQR16	20.5	34.5	24.5	24.5	24.5	30.5	37.5	55.5	55.5	—	26.5	16.5	16.5	16.5	22.5	29.5	47.5	47.5	—	24.5	14.5	14.5	14.5	20.5	27.5	45.5	45.5	—			
MXQR20	23	47.5	37.5	27.5	37.5	35.5	43.5	75.5	78.5	81.5	39.5	29.5	19.5	19.5	27.5	35.5	67.5	70.5	75.5	37.5	27.5	17.5	17.5	25.5	33.5	65.5	68.5	73.5			
MXQR25	27	56.5	46.5	36.5	36.5	50.5	50.5	64.5	92.5	92.5	48.5	38.5	28.5	28.5	42.5	42.5	56.5	84.5	75.5	46.5	36.5	26.5	26.5	40.5	40.5	54.5	82.5	73.5			

Reed Auto Switch: D-A90, D-A93, D-A96, D-A90V, D-A93V, D-A96V

Model	A	B										E									
		Stroke										Stroke									
		10	20	30	40	50	75	100	125	150	10	20	30	40	50	75	100	125	150		
MXQR6	6	5.5	5.5	5.5	13.5	13.5	—	—	—	—	3.5 (1)	3.5 (1)	3.5 (1)	11.5 (9)	11.5 (9)	—	—	—	—		
MXQR8	7.5	8	8	12	16	31	32	—	—	—	6 (3.5)	6 (3.5)	10 (7.5)	14 (11.5)	29 (26.5)	30 (27.5)	—	—	—		
MXQR12	11.5	24.5	14.5	14.5	21.5	21.5	40.5	40.5	—	—	22.5 (20)	12.5 (10)	12.5 (10)	19.5 (17)	19.5 (17)	38.5 (36)	38.5 (36)	—	—		
MXQR16	16.5	30.5	20.5	20.5	20.5	26.5	33.5	51.5	51.5	—	28.5 (26)	18.5 (16)	18.5 (16)	18.5 (16)	24.5 (22)	31.5 (29)	49.5 (47)	49.5 (47)	—		
MXQR20	19	43.5	33.5	23.5	33.5	31.5	39.5	71.5	74.5	77.5	41.5 (39)	31.5 (29)	21.5 (19)	31.5 (29)	29.5 (27)	37.5 (35)	69.5 (67)	72.5 (70)	77.5 (75)		
MXQR25	22	52.5	42.5	32.5	32.5	46.5	46.5	60.5	88.5	88.5	50.5 (48)	40.5 (38)	30.5 (28)	30.5 (28)	44.5 (42)	44.5 (42)	58.5 (56)	86.5 (84)	77.5 (75)		

Note) Adjust the auto switch after confirming the operating conditions in the actual setting. (): D-A93

Auto Switch Mounting

⚠ Caution

Auto switch mounting tool

- When tightening the set screw (included with auto switch), use a watchmaker's screwdriver with a handle about 5 to 6 mm in diameter.

Tightening torque

Tightening Torque of Auto Switch Mounting Screw (N·m)

Auto switch model	Tightening torque
D-A9□(V)	0.10 to 0.20
D-M9□(V)	0.05 to 0.15
D-M9□W(V)	
D-M9□A(V)	0.05 to 0.10

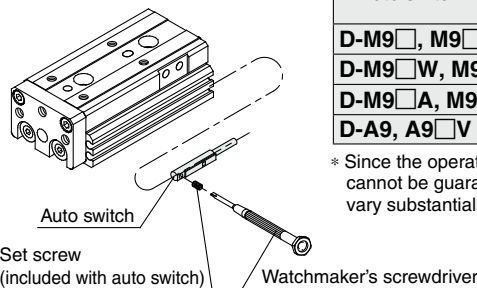

Operating Range

Operating Range

(mm)

Auto switch model	Applicable bore size					
	6	8	12	16	20	25
D-M9□, M9□V	3	3	3.5	4.5	4.5	5.5
D-M9□W, M9□WV						
D-M9□A, M9□AV						
D-A9, A9□V	4.5	5	6	7	8	9

* Since the operating range is provided as a guideline including hysteresis, it cannot be guaranteed (assuming approximately ±30% dispersion). It may vary substantially depending on the ambient environment.

Other than the applicable auto switches listed in "How to Order", the following auto switches can be mounted.

* Normally closed (NC = b contact) solid state auto switches (D-F9G/F9H) and solid state auto switch (D-F8) are also available. Refer to Best Pneumatics No. 3 for details.

Prior to Use

Auto Switch Connection and Example

Sink Input Specifications

3-wire, NPN

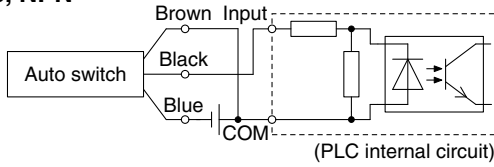

2-wire

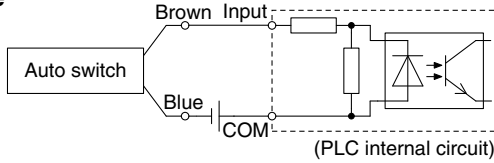

Source Input Specifications

3-wire, PNP

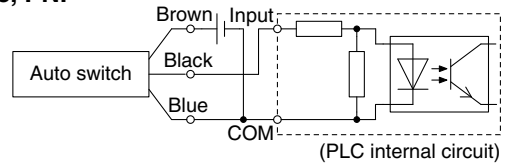

2-wire

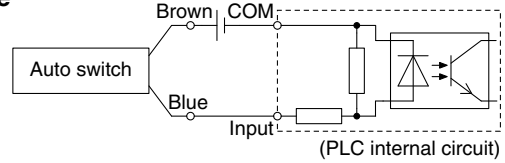

Connect according to the applicable PLC input specifications, as the connection method will vary depending on the PLC input specifications.

Example of AND (Series) and OR (Parallel) Connection

* When using solid state auto switches, ensure the application is set up so the signals for the first 50 ms are invalid.

3-wire AND connection for NPN output (Using relays)

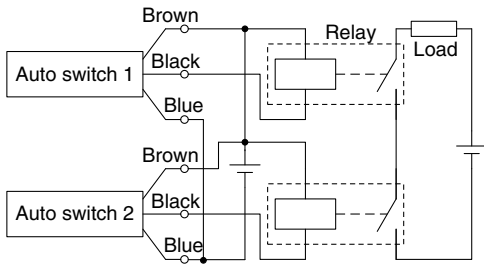

(Performed with auto switches only)

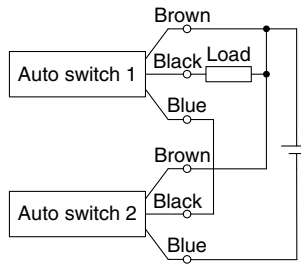

3-wire OR connection for NPN output

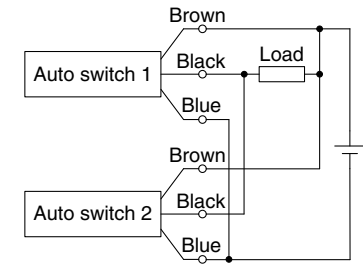

3-wire AND connection for PNP output (Using relays)

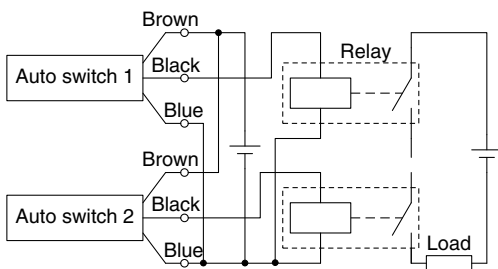

(Performed with auto switches only)

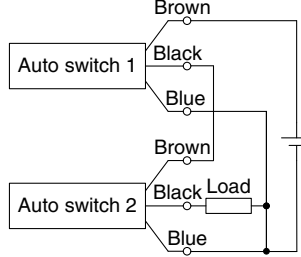

3-wire OR connection for PNP output

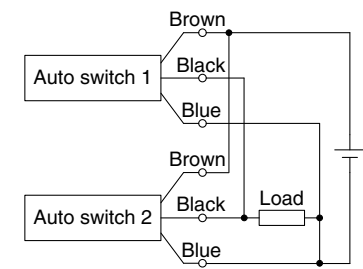

2-wire AND connection

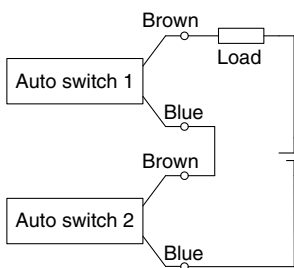

When two auto switches are connected in series, a load may malfunction because the load voltage will decline when in the ON state. The indicator lights will light up when both of the auto switches are in the ON state. Auto switches with load voltage less than 20 V cannot be used.

$$\begin{aligned} \text{Load voltage at ON} &= \text{Power supply voltage} - \\ &= \text{Residual voltage} \times 2 \text{ pcs.} \\ &= 24 \text{ V} - 4 \text{ V} \times 2 \text{ pcs.} \\ &= 16 \text{ V} \end{aligned}$$

Example: Power supply is 24 VDC
Internal voltage drop in auto switch is 4 V.

2-wire OR connection

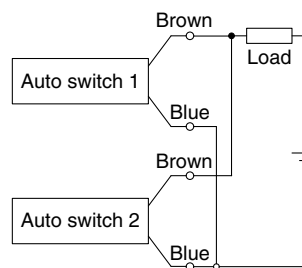

(Solid state)
When two auto switches are connected in parallel, malfunction may occur because the load voltage will increase when in the OFF state.

(Reed)
Because there is no current leakage, the load voltage will not increase when turned OFF. However, depending on the number of auto switches in the ON state, the indicator lights may sometimes grow dim or not light up, due to the dispersion and reduction of the current flowing to the auto switches.

$$\begin{aligned} \text{Load voltage at OFF} &= \text{Leakage current} \times 2 \text{ pcs.} \times \\ &= \text{Load impedance} \\ &= 1 \text{ mA} \times 2 \text{ pcs.} \times 3 \text{ k}\Omega \\ &= 6 \text{ V} \end{aligned}$$

Example: Load impedance is 3 kΩ.
Leakage current from auto switch is 1 mA.

Made to Order Individual Specifications: Air Slide Table/Reversible Type Series *MXQR*



Please contact SMC for detailed dimensions, specifications, and lead times.

1 PTFE Grease Symbol **-X7**

MXQR Standard model no. — **X7**
● PTFE grease

PTFE grease is used for all parts that grease is applied.

Specifications

Type	PTFE grease
Bore size (mm)	6, 8, 12, 16, 20, 25

* Specifications and dimensions other than the above are the same as those for mounting the adjuster on the right side.

Warning

Precautions

Be aware that smoking cigarettes, etc. after your hands have come into contact with the grease used in this cylinder can create a gas that is hazardous to humans.

2 Grease for Food Processing Equipment Symbol **-X9**

MXQR Standard model no. — **X9**
● Grease for food processing equipment

Grease for food processing equipment is used for all parts that grease is applied.

Specifications

Type	Grease for food processing machines (NSF-H1 certified)/ Aluminum complex soap base grease
Bore size (mm)	6, 8, 12, 16, 20, 25

* Specifications and dimensions other than the above are the same as those for mounting the adjuster on the right side.

Caution

Do not use this cylinder in a food-related environment.

<Cannot be mounted>

Food zone.....Food may directly contact with this cylinder, and is treated as food products.

Splash zone.....Food may directly contact with this cylinder, but is not treated as food products.

<Can be mounted>

Non-food zone.....This cylinder do not directly contact food.

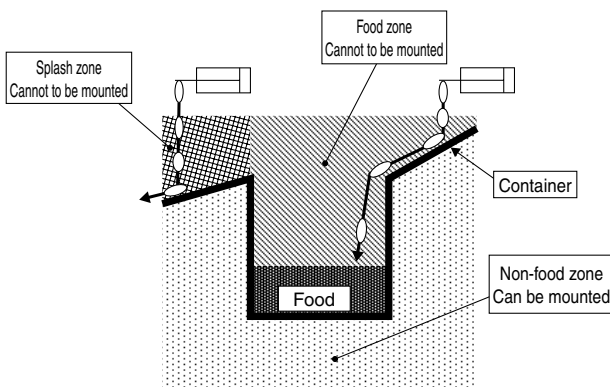

3 Long Adjustment Bolt (Adjustment range: 15 mm) Symbol **-X11**

MXQR Standard model no. — **X11**
● Long adjustment bolt (Adjustment range: 15 mm)

* -X11 is not available with those with a shock absorber (JS, JT, J, BS, BT, B).

The stroke adjustment range was extended from 5 mm to 15 mm with a long adjustment bolt.

Dimensions

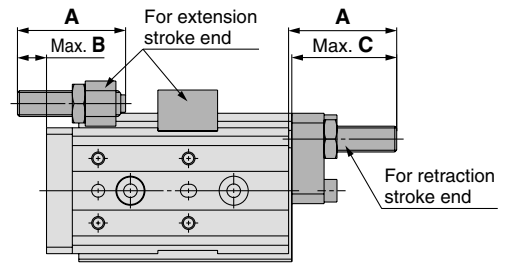

Rubber Stopper (AS, AT, A) (mm)

Model	A	B	C
MXQR6	26.5	10	25.5
MXQR8	29.5	10	28.5
MXQR12	33.5	9	32.5
MXQR16	34.5	6.5	33.5
MXQR20	37.5	3.5	36.5
MXQR25	42.5	2.5	41.5

Metal Stopper (CS, CT, C) (mm)

Model	A	B	C
MXQR6	25.5	10	24.5
MXQR8	28	9.5	27
MXQR12	32	8.5	31
MXQR16	33	6	32
MXQR20	37	4	36
MXQR25	40	1	39

4 Long Adjustment Bolt (Adjustment range: 25 mm) Symbol **-X12**

MXQR Standard model no. — **X12**
● Long adjustment bolt (Adjustment range: 25 mm)

* -X12 is not available with the MXQR6.

* -X12 is not available with those with a shock absorber (JS, JT, J, BS, BT, B).

The stroke adjustment range was extended from 5 mm to 25 mm with a long adjustment bolt.

Dimensions

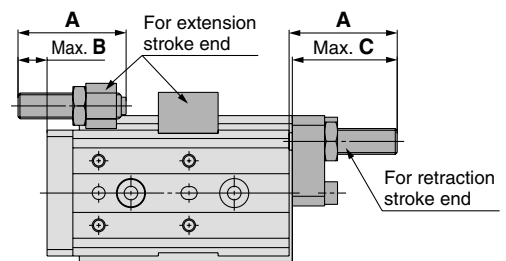

Rubber Stopper (AS, AT, A) (mm)

Model	A	B	C
MXQR8	39.5	20	38.5
MXQR12	43.5	19	42.5
MXQR16	44.5	16.5	43.5
MXQR20	47.5	13.5	46.5
MXQR25	52.5	12.5	51.5

Metal Stopper (CS, CT, C) (mm)

Model	A	B	C
MXQR8	38	19.5	37
MXQR12	42	18.5	41
MXQR16	43	16	42
MXQR20	47	14	46
MXQR25	50	11	49

5 Heat Treated Metal Stopper Bolt (Adjustment range: 5 mm) Symbol **-X16**

MXQR Standard model no. — **X16**
● Metal stopper

Heat treated chrome-molybdenum steel (SCM435) stroke adjusting thread is used to reduce wearing of metal stopper.

Specifications

Type	Heat treated metal stopper bolt
Bore size (mm)	6, 8, 12, 16, 20, 25
Piston speed	50 to 200 mm/s
Cushion	None
Stroke adjustment range	0 to 5 mm

* Specifications and dimensions other than the above are the same as those for mounting the adjuster on the right side.

Made to Order Individual Specifications: Air Slide Table/Reversible Type Series *MXQR*



Please contact SMC for detailed dimensions, specifications, and lead times.

6 Heat Treated Metal Stopper Bolt (Adjustment range: 15 mm) **-X17**

MXQR Standard model no. **- X17**
 ● Metal stopper (Adjustment range: 15 mm)

Heat treated chrome-molybdenum steel (SCM435) stroke adjusting thread is used to reduce wearing of metal stopper. The stroke adjustment range was extended from 5 mm to 15 mm with a long adjustment bolt.

Dimensions

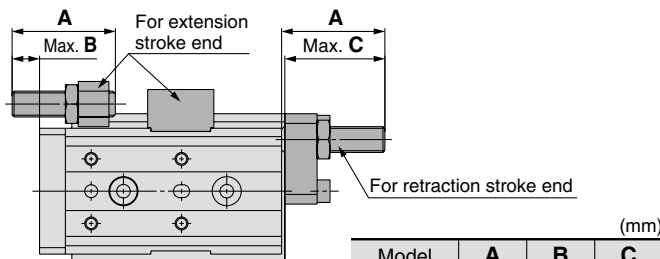

	(mm)		
Model	A	B	C
MXQR6	25.5	10	24.5
MXQR8	28	9.5	27
MXQR12	32	8.5	31
MXQR16	33	6	32
MXQR20	37	4	36
MXQR25	40	1	39

7 Heat Treated Metal Stopper Bolt (Adjustment range: 25 mm) **-X18**

MXQR Standard model no. **- X18**
 ● Metal stopper (Adjustment range: 25 mm)

* -X18 is not available with the MXQR6.

Heat treated chrome-molybdenum steel (SCM435) stroke adjusting thread is used to reduce wearing of metal stopper. The stroke adjustment range was extended from 5 mm to 25 mm with a long adjustment bolt.

Dimensions

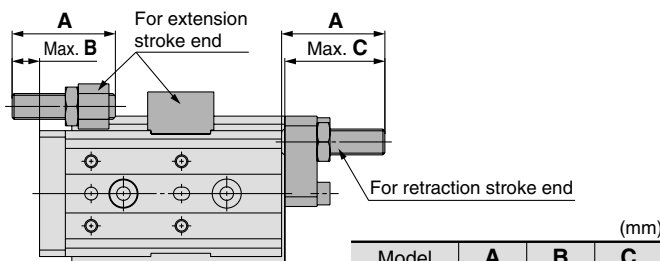

	(mm)		
Model	A	B	C
MXQR8	38	19.5	37
MXQR12	42	18.5	41
MXQR16	43	16	42
MXQR20	47	14	46
MXQR25	50	11	49

8 Without Built-in Auto Switch Magnet **-X33**

MXQR Standard model no. **- X33**
 Without built-in auto switch magnet

This product does not have a magnet for an auto switch. It is suitable for applications where magnetic force is not acceptable.

Specifications

Type	Without built-in auto switch magnet
Bore size (mm)	6, 8, 12, 16, 20, 25
Auto switch	Not mountable

* Specifications and dimensions other than the above are the same as those for mounting the adjuster on the right side.

9 Fluororubber Seal **-X39**

MXQR Standard model no. **- X39**
 ● Fluororubber seal

Change the materials for the piston seal, rod seal, O-rings and scrapers (rubber lined parts) to fluororubber.

Specifications

Type	Fluororubber seal
Bore size (mm)	6, 8, 12, 16, 20, 25
Seal material	Fluororubber

* Specifications and dimensions other than the above are the same as those for mounting the adjuster on the right side.

10 Anti-corrosive Guide Unit **-X42**

MXQR Standard model no. **- X42**
 ● Anti-corrosive guide unit

Martensitic stainless steel is used for table and guide block. Use this treatment if more effective anti-corrosiveness is necessary. Table and guide block are given anti-corrosive treatment.

Specifications

Type	Anti-corrosive guide unit
Bore size (mm)	6, 8, 12, 16, 20, 25
Surface treatment	Special anti-corrosive treatment *2

*1 Specifications and dimensions other than the above are the same as those for mounting the adjuster on the right side.

*2 Special anti-corrosive treatment makes the table and the guide block black.

11 EPDM Seal **-X45**

MXQR Standard model no. **- X45**
 ● EPDM seal

Change the materials for the piston seal, rod seal, O-rings and scrapers (rubber lined parts) to EPDM.

Specifications

Type	EPDM seal
Bore size (mm)	6, 8, 12, 16, 20, 25
Seal material	EPDM
Grease	PTFE grease



* Specifications and dimensions other than the above are the same as those for mounting the adjuster on the right side.

Warning Precautions

Be aware that smoking cigarettes, etc. after your hands have come into contact with the grease used in this cylinder can create a gas that is hazardous to humans.

Safety Instructions

These safety instructions are intended to prevent hazardous situations and/or equipment damage. These instructions indicate the level of potential hazard with the labels of “**Caution**,” “**Warning**” or “**Danger**.” They are all important notes for safety and must be followed in addition to International Standards (ISO/IEC)*1, and other safety regulations.

-  **Caution:** **Caution** indicates a hazard with a low level of risk which, if not avoided, could result in minor or moderate injury.
-  **Warning:** **Warning** indicates a hazard with a medium level of risk which, if not avoided, could result in death or serious injury.
-  **Danger :** **Danger** indicates a hazard with a high level of risk which, if not avoided, will result in death or serious injury.

- *1) ISO 4414: Pneumatic fluid power – General rules relating to systems.
ISO 4413: Hydraulic fluid power – General rules relating to systems.
IEC 60204-1: Safety of machinery – Electrical equipment of machines.
(Part 1: General requirements)
ISO 10218-1: Manipulating industrial robots - Safety.
etc.

Warning

1. The compatibility of the product is the responsibility of the person who designs the equipment or decides its specifications.

Since the product specified here is used under various operating conditions, its compatibility with specific equipment must be decided by the person who designs the equipment or decides its specifications based on necessary analysis and test results. The expected performance and safety assurance of the equipment will be the responsibility of the person who has determined its compatibility with the product. This person should also continuously review all specifications of the product referring to its latest catalog information, with a view to giving due consideration to any possibility of equipment failure when configuring the equipment.

2. Only personnel with appropriate training should operate machinery and equipment.

The product specified here may become unsafe if handled incorrectly. The assembly, operation and maintenance of machines or equipment including our products must be performed by an operator who is appropriately trained and experienced.

3. Do not service or attempt to remove product and machinery/equipment until safety is confirmed.

1. The inspection and maintenance of machinery/equipment should only be performed after measures to prevent falling or runaway of the driven objects have been confirmed.
2. When the product is to be removed, confirm that the safety measures as mentioned above are implemented and the power from any appropriate source is cut, and read and understand the specific product precautions of all relevant products carefully.
3. Before machinery/equipment is restarted, take measures to prevent unexpected operation and malfunction.

4. Contact SMC beforehand and take special consideration of safety measures if the product is to be used in any of the following conditions.

1. Conditions and environments outside of the given specifications, or use outdoors or in a place exposed to direct sunlight.
2. Installation on equipment in conjunction with atomic energy, railways, air navigation, space, shipping, vehicles, military, medical treatment, combustion and recreation, or equipment in contact with food and beverages, emergency stop circuits, clutch and brake circuits in press applications, safety equipment or other applications unsuitable for the standard specifications described in the product catalog.
3. An application which could have negative effects on people, property, or animals requiring special safety analysis.
4. Use in an interlock circuit, which requires the provision of double interlock for possible failure by using a mechanical protective function, and periodical checks to confirm proper operation.

Caution

1. The product is provided for use in manufacturing industries.

The product herein described is basically provided for peaceful use in manufacturing industries.

If considering using the product in other industries, consult SMC beforehand and exchange specifications or a contract if necessary.

If anything is unclear, contact your nearest sales branch.

Limited warranty and Disclaimer/ Compliance Requirements

The product used is subject to the following “Limited warranty and Disclaimer” and “Compliance Requirements”.

Read and accept them before using the product.

Limited warranty and Disclaimer

1. The warranty period of the product is 1 year in service or 1.5 years after the product is delivered.*2)
Also, the product may have specified durability, running distance or replacement parts. Please consult your nearest sales branch.

2. For any failure or damage reported within the warranty period which is clearly our responsibility, a replacement product or necessary parts will be provided.

This limited warranty applies only to our product independently, and not to any other damage incurred due to the failure of the product.

3. Prior to using SMC products, please read and understand the warranty terms and disclaimers noted in the specified catalog for the particular products.

*2) Vacuum pads are excluded from this 1 year warranty.

A vacuum pad is a consumable part, so it is warranted for a year after it is delivered.

Also, even within the warranty period, the wear of a product due to the use of the vacuum pad or failure due to the deterioration of rubber material are not covered by the limited warranty.

Compliance Requirements

1. The use of SMC products with production equipment for the manufacture of weapons of mass destruction (WMD) or any other weapon is strictly prohibited.

2. The exports of SMC products or technology from one country to another are governed by the relevant security laws and regulations of the countries involved in the transaction. Prior to the shipment of a SMC product to another country, assure that all local rules governing that export are known and followed.

Safety Instructions

Be sure to read “Handling Precautions for SMC Products” (M-E03-3) before using.