

Low Profile 2/3-Port Solenoid Valve

New

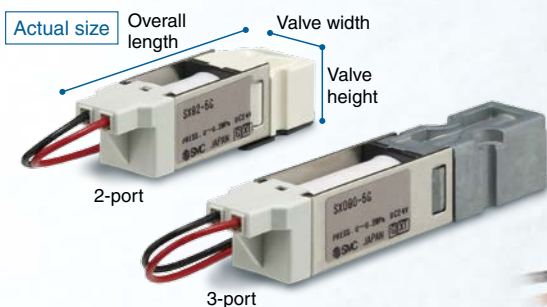

Compact



Overall length	2-port	3-port
	Approx. 38 mm / 54 mm	
Valve width/height	10 mm	
Weight	2-port	3-port
	10 g / 20 g	



Large flow rate

	2-port/N.C.	3-port
C [dm ³ /(s·bar)]	0.25	0.5
Flow rate [L/min (ANR)]	45*1	90*1

*1 At 0.2 MPa

Application example

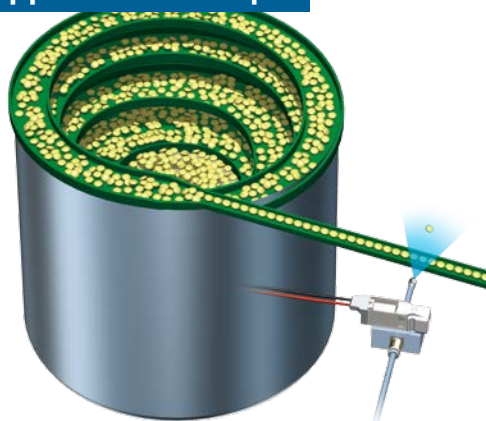

For various industries!



(For use in medical equipment, please contact your SMC sales representative.)

SX90/090 Series



CAT.ES70-59A

Low Profile 2/3-Port Solenoid Valve

SX90/090 Series



How to Order

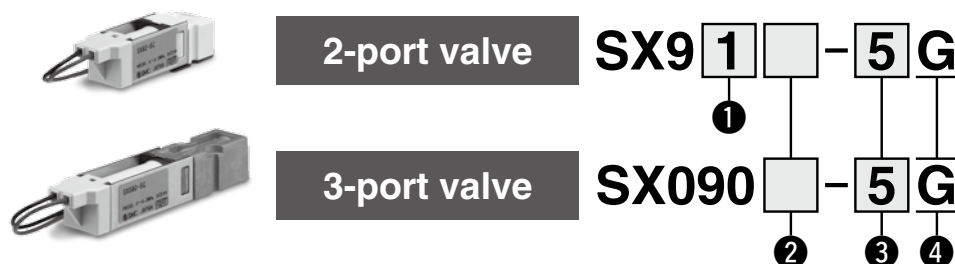

1 Type of actuation

1	Normally closed
2	Universal

2 Power-saving circuit

Nil	Without power-saving circuit
Y1	With power-saving circuit

3 Rated voltage

5	24 VDC
6	12 VDC

4 Electrical entry

G	Grommet (Lead wire length: 300 mm)
---	---------------------------------------

Specifications

Model		SX91		SX92		SX090			
Valve specifications	Valve construction	2-port direct operated poppet valve		2-port direct operated poppet valve		3-port direct operated poppet valve			
	Type of actuation	Normally closed		Universal		Universal			
	Fluid*1			Air, Nitrogen					
	Operating pressure range [MPa]			-100 kPa to 0.2					
	Proof pressure [MPa]			0.6					
	Ambient and fluid temperatures [°C]*2			0 to 50					
	C [dm ³ /(s·bar)]	0.25		0.12		0.5			
	Cv	0.07		0.032		0.14			
	b	0.25		0.25		0.3			
	Flow rate [L/min (ANR)] at 0.2 MPa*4	45		22		90			
	Response time [msec]*3	ON, OFF: 10 or less				ON, OFF: 15 or less			
Impact/Vibration resistance [m/s ²]	150/30								
Mounting orientation	Unrestricted								
Enclosure	IP40								
Weight [g]	10				20				
Electric specifications	Inrush*2	Rated voltage/Power consumption		12 VDC/4 W	24 VDC/4 W	12 VDC/4 W	24 VDC/4 W	12 VDC/6 W	24 VDC/6 W
		Holding*2		5 VDC (Rated 42%)/0.7 W	10 VDC (Rated 42%)/0.7 W	5 VDC (Rated 42%)/0.7 W	10 VDC (Rated 42%)/0.7 W	4.2 VDC (Rated 35%)/0.8 W	8.4 VDC (Rated 35%)/0.8 W
	Allowable voltage fluctuation*5		±10% of rated voltage (0 to +10%)						
	Type of coil insulation		Class B						

*1 For use with fluids other than air or nitrogen, please contact your SMC sales representative.

*2 Please make sure the coil surface temperature does not exceed 80°C. As a guide, please refer to [Inrush], [Holding], and [T2 (OFF)] in the figure below. Please check each application as the surface temperature is application dependent.

*3 2-port (SX91/92): Based on dynamic performance test, JIS B 8373.
(Coil temperature: 20°C, at rated voltage)
3-port (SX090): Based on dynamic performance test, JIS B 8419.
(Coil temperature: 20°C, at rated voltage)

Use of the product under the conditions and environment below may cause delay in the response (switching) of the valve during start-up.

- The first operation after a long period of inactivity
- When using at low supply pressure (0.1 MPa or less)
- When using in an environment where the ambient and fluid temperature is low (10°C or less)

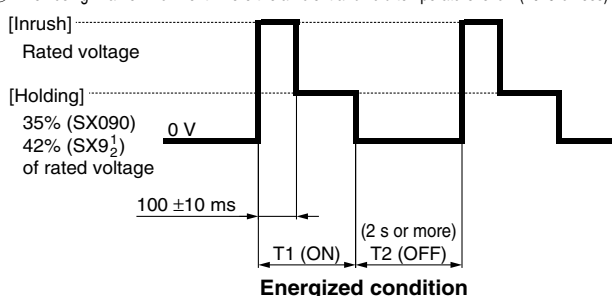

*4 The flow rate is measured when the pressure difference is 0.2 MPa. Please refer to the graph below for the relationship between the flow rate and pressure difference.

*5 For the solenoid valve with power-saving circuit, the allowable voltage fluctuation is between 0 and +10%.

Relationship Between Flow Rate and Pressure Difference (Representative values)

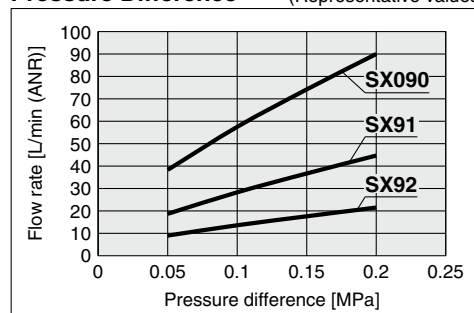

Dimensions

2-port

SX91/Normally closed
SX92/Universal

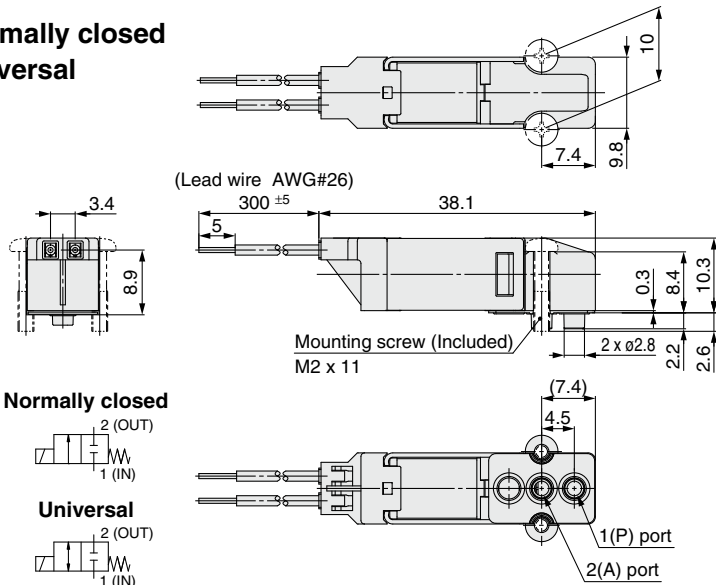

Base hole dimension

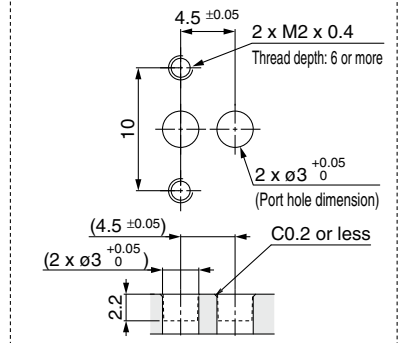

3-port

SX090/Universal

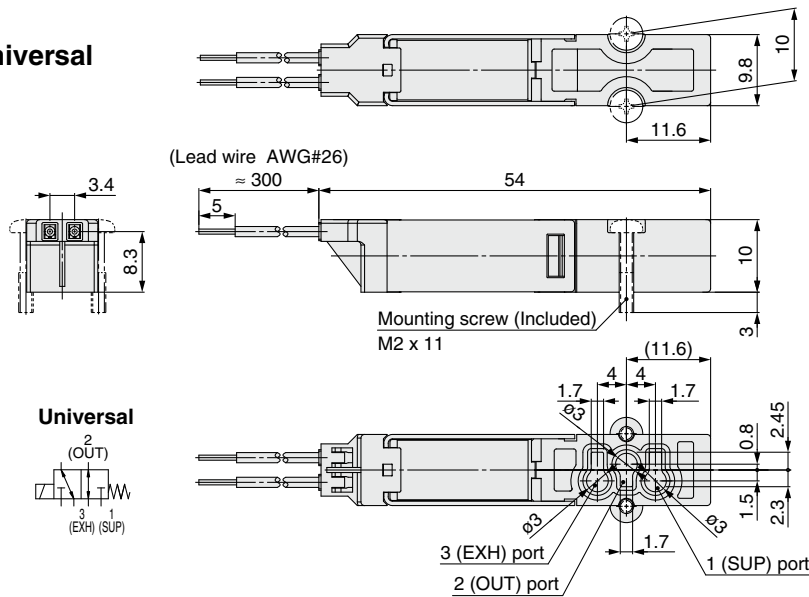

Base hole dimension ①

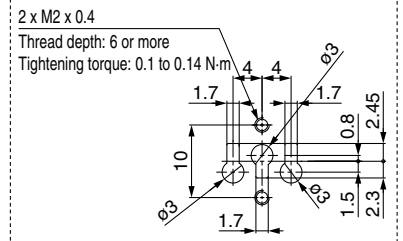

Base hole dimension ②

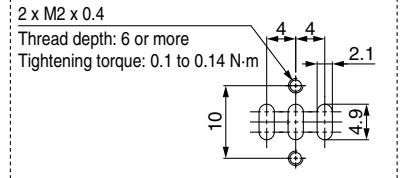

⚠ Specific Product Precautions

Be sure to read this before handling the products.
Refer to the back cover for safety instructions.

Continuous Energization

⚠ Caution

- For the solenoid valve without power-saving circuit, continuous energization is not allowed at the start-up voltage (rated voltage) as there is a risk of damaging the coil. For continuous energization with the holding voltage, please make sure the coil surface temperature does not exceed 80°C.
- Coil temperature may get high due to ambient temperature or energizing duration. Do not touch the valve by hand directly. When there is such a dangerous case to be touched by hands directly, install a protective cover.
- When using the solenoid valves on a manifold, note that the temperature rise will be larger if three or more adjacent valves are energized together. Please ensure that the coil surface temperature does not exceed 80°C in the actual operating conditions.

Manual Override

⚠ Caution

- To operate the manual override to the ON position, press the button fully in the direction of the arrow (approximately 0.5 mm). The valve will be turned OFF when the button is released. (For 3-port valve)

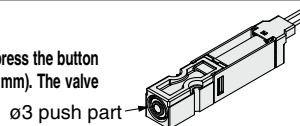

Valve Mounting

⚠ Caution

- Confirm that the gasket is correctly mounted on the body interface and then tighten the screws to the specified torque. (Fasten equally so that the valve will not tilt.) The specified torque is from 0.10 to 0.14 N·m, please apply a torque setting depending on the base condition and operating environment.
- Please do not apply force to the coil and frame when installing the piping and valves. If they receive 10 N or more of force, a malfunction may occur.
- Do not pull the lead wire with excessive force. Applying 10 N or more of load may result in broken wire or contact failure.

Safety Instructions

These safety instructions are intended to prevent hazardous situations and/or equipment damage. These instructions indicate the level of potential hazard with the labels of “**Caution**,” “**Warning**” or “**Danger**.” They are all important notes for safety and must be followed in addition to International Standards (ISO/IEC)*1), and other safety regulations.

 **Caution:** **Caution** indicates a hazard with a low level of risk which, if not avoided, could result in minor or moderate injury.

 **Warning:** **Warning** indicates a hazard with a medium level of risk which, if not avoided, could result in death or serious injury.

 **Danger :** **Danger** indicates a hazard with a high level of risk which, if not avoided, will result in death or serious injury.

*1) ISO 4414: Pneumatic fluid power – General rules relating to systems.
ISO 4413: Hydraulic fluid power – General rules relating to systems.
IEC 60204-1: Safety of machinery – Electrical equipment of machines.
(Part 1: General requirements)
ISO 10218-1: Manipulating industrial robots – Safety.
etc.

Warning

1. The compatibility of the product is the responsibility of the person who designs the equipment or decides its specifications.

Since the product specified here is used under various operating conditions, its compatibility with specific equipment must be decided by the person who designs the equipment or decides its specifications based on necessary analysis and test results. The expected performance and safety assurance of the equipment will be the responsibility of the person who has determined its compatibility with the product. This person should also continuously review all specifications of the product referring to its latest catalog information, with a view to giving due consideration to any possibility of equipment failure when configuring the equipment.

2. Only personnel with appropriate training should operate machinery and equipment.

The product specified here may become unsafe if handled incorrectly. The assembly, operation and maintenance of machines or equipment including our products must be performed by an operator who is appropriately trained and experienced.

3. Do not service or attempt to remove product and machinery/equipment until safety is confirmed.

1. The inspection and maintenance of machinery/equipment should only be performed after measures to prevent falling or runaway of the driven objects have been confirmed.
2. When the product is to be removed, confirm that the safety measures as mentioned above are implemented and the power from any appropriate source is cut, and read and understand the specific product precautions of all relevant products carefully.
3. Before machinery/equipment is restarted, take measures to prevent unexpected operation and malfunction.

4. Contact SMC beforehand and take special consideration of safety measures if the product is to be used in any of the following conditions.

1. Conditions and environments outside of the given specifications, or use outdoors or in a place exposed to direct sunlight.
2. Installation on equipment in conjunction with atomic energy, railways, air navigation, space, shipping, vehicles, military, medical treatment, combustion and recreation, or equipment in contact with food and beverages, emergency stop circuits, clutch and brake circuits in press applications, safety equipment or other applications unsuitable for the standard specifications described in the product catalog.
3. An application which could have negative effects on people, property, or animals requiring special safety analysis.
4. Use in an interlock circuit, which requires the provision of double interlock for possible failure by using a mechanical protective function, and periodical checks to confirm proper operation.

Caution

1. The product is provided for use in manufacturing industries.

The product herein described is basically provided for peaceful use in manufacturing industries.
If considering using the product in other industries, consult SMC beforehand and exchange specifications or a contract if necessary.
If anything is unclear, contact your nearest sales branch.

Limited warranty and Disclaimer/ Compliance Requirements

The product used is subject to the following “Limited warranty and Disclaimer” and “Compliance Requirements”.

Read and accept them before using the product.

Limited warranty and Disclaimer

1. The warranty period of the product is 1 year in service or 1.5 years after the product is delivered, whichever is first.*2)
Also, the product may have specified durability, running distance or replacement parts. Please consult your nearest sales branch.
2. For any failure or damage reported within the warranty period which is clearly our responsibility, a replacement product or necessary parts will be provided.
This limited warranty applies only to our product independently, and not to any other damage incurred due to the failure of the product.
3. Prior to using SMC products, please read and understand the warranty terms and disclaimers noted in the specified catalog for the particular products.

*2) Vacuum pads are excluded from this 1 year warranty.

A vacuum pad is a consumable part, so it is warranted for a year after it is delivered.
Also, even within the warranty period, the wear of a product due to the use of the vacuum pad or failure due to the deterioration of rubber material are not covered by the limited warranty.

Compliance Requirements

1. The use of SMC products with production equipment for the manufacture of weapons of mass destruction (WMD) or any other weapon is strictly prohibited.
2. The exports of SMC products or technology from one country to another are governed by the relevant security laws and regulations of the countries involved in the transaction. Prior to the shipment of a SMC product to another country, assure that all local rules governing that export are known and followed.

Caution

SMC products are not intended for use as instruments for legal metrology.

Measurement instruments that SMC manufactures or sells have not been qualified by type approval tests relevant to the metrology (measurement) laws of each country. Therefore, SMC products cannot be used for business or certification ordained by the metrology (measurement) laws of each country.

 **Safety Instructions** Be sure to read the “Handling Precautions for SMC Products” (M-E03-3) and “Operation Manual” before use.

SMC Corporation

Akihabara UDX 15F,
4-14-1, Sotokanda, Chiyoda-ku, Tokyo 101-0021, JAPAN
Phone: 03-5207-8249 Fax: 03-5298-5362
<https://www.smcworld.com>
© 2019 SMC Corporation All Rights Reserved

Specifications are subject to change without prior notice and any obligation on the part of the manufacturer.

D-G

1st printing AA printing AA 0000AA Printed in Japan.