

# Electronic Pressure Sensor 34D

Operation manual  
for versions:  
34D-xxxxx-DDx-xx  
2 x PNP (1 x IO-Link,  
Configurable)

Engineering  
GREAT Solutions





## Content

1. Preliminary note	4
1.1 Symbols used	4
2. Safety instructions	4
3. Intended Use	5
3.1 Applications	5
4. Function	6
4.1 Communication, parameter setting, evaluation	6
4.2 Switching function	6
4.3 IO-Link	7
5. Installation	7
6. Electrical connection	8
7. Operating and display elements	9
8. Menu	10
8.1 Menu structure: Main menu	10
8.2 Explanation of the menu	11
8.2.1 Explanation of the menu level 1	11
8.2.2 Explanation of the menu level 2	11
9. Parameter setting	12
9.1 Parameter setting in general	12
9.2 Configure display (optional)	15
9.3 Set output signals	15
9.3.1 Set output functions	15
9.3.2 Define switching limits for the hysteresis function	16
9.3.3 Define switching limits for the window function	16
9.4 User settings (optional)	16
9.4.1 Set delay for the switching outputs	16
9.4.2 Set output logic for the switching outputs	16
9.4.3 Set damping for the switching signal	16





9.4.4 Read min-/max values for the system pressure	17
9.4.5 Reset all parameters to factory setting	17
9.4.6 Set colour change of the display	17
9.4.7 Graphical illustration of the colour change of the display	18
10. Operation	21
10.1 Read set parameters	21
10.2 Self-diagnosis / error indications	21
11. Technical data	22
11.1 Setting ranges	22
11.2 Further technical data	22
12 Factory setting	23



## 1. Preliminary note

### 1.1 Symbols used

- ▶ Instructions
- > Reaction, result
- [...] Designation of keys, buttons or displays
- Cross-reference
-  Important note, Non-compliance can result in malfunction or interference.
-  Information
-  Supplementary note

## 2. Safety instructions

- ⓘ Please read this document prior to set-up of the unit. Ensure that the product is suitable for your application without any restrictions.
  - ⓘ If the operating instructions or the technical data are not adhered to, personal injury and/or damage to property can occur.
  - ⓘ Check the compatibility of the product materials with the media to be measured in all applications.
  - ⓘ Correct condition of the device for the operating time can only be guaranteed if the device is only used for media to which the wetted materials are sufficiently resistant → 3.1 Applications.
  - ⓘ If the devices are used in gas applications with pressures > 25 bar the notes in chapter 3.1 for devices with the marking \*) must be absolutely observed.
-  The responsibility whether the measurement device is suitable for the respective application lies with the operator. The manufacturer assumes no liability for consequences of misuse by the operator. Improper installation and use of the devices results in a loss of the warranty claims.

### 3. Intended Use

The device monitors the system pressure of machines and installations.

#### 3.1 Applications



Type of pressure: relative pressure

Order number	Measuring range		Permissible overpressure <sup>*)</sup>		Bursting pressure	
	bar	PSI	bar	PSI	bar	PSI
Pressure sensors with internal thread G¼						
34D-P600...	0...600	0...8700	800	11580	2500	36250
34D-P400...	0...400	0...5800	800	11580	1700	24650
34D-P250...	0...250	0...3625	500	7250	1200	17400
34D-P160...	0...160	0...2320	350	5075	1000	14500
34D-P100...	0...100	0...1450	300	4350	650	9400
34D-P040...	0...40	0...580	200	2900	500	7250
34D-P016...	0...16	0...232	85	1225	500	2900
34D-V110...	-1...10	-14,5...145	75	1087	150	2175
34D-V101...	-1...1	-14,5...14,5	10	145	30	450

<sup>\*)</sup> With static overload pressure or max. 100 million pressure cycles.

MPa = (measured value in bar) + 10

kPa = (measured value in bar) x 100

-  Media used must be compatible with the materials specified in the data sheet
-  Avoid static and dynamic overpressure exceeding the specified overload pressure by taking appropriate measures.

The indicated bursting pressure must not be exceeded.

Even if the bursting pressure is exceeded only for a short time, the unit may be destroyed.

ATTENTION: Risk of injury!

## 4. Function

- ☞ The unit displays the current system pressure.
- ☞ It generates output signals according to the operating mode and the parameter setting.
- ☞ It moreover provides the process data via IO-Link.
- ☞ The unit is laid out for fully bidirectional communication. So, the following options are possible:
  - Remote display: reading and display of the current system pressure.
  - Remote parameter setting: reading and changing the current parameter setting. - IO-Link parameter setting → 4.3

### 4.1 Communication, parameter setting, evaluation

<b>OUT1 (Pin 4)</b>	<ul style="list-style-type: none"> <li>☞ Switching signal for system pressure limit value</li> <li>☞ Communication via IO-Link</li> </ul>
<b>OUT2 (Pin 2)</b>	☞ Switching signal for system pressure limit value

### 4.2 Switching function

OUTx changes its switching state if it is above or below the set switching limits (SPx, rPx). The following switching functions can be selected:

- ☞ Hysteresis function / normally open:  $[OUx] = [Hno]$  (→ fig. 1)
- ☞ Hysteresis function / normally closed:  $[OUx] = [Hnc]$  (→ fig. 1)

First the set point (SPx) is set, then the reset point (rPx). The hysteresis defined remains even if SPx is changed again.

- ☞ Window function / normally open:  $[OUx] = [Fno]$  (→ fig. 2).
- ☞ Window function / normally closed:  $[OUx] = [Fnc]$  (→ fig. 2).

The width of the window can be set by means of the difference between FHx and FLx. FHx = upper value, FLx = lower value.

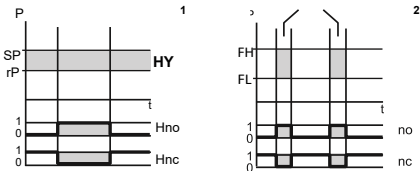

P = system pressure; HY = hysteresis; FE = window



### 4.3 IO-Link General Information

This unit has an IO-Link communication interface which requires an IO-Link-capable module (IO-Link master) for operation.

The IO-Link interface enables direct access to the process and diagnostic data and provides the possibility to set the parameters of the unit during operation.

In addition communication is possible via a point-to-point connection with a USB adapter cable.

#### Device-specific Information

You can find the IODDs necessary for the configuration of the IO-Link unit and detailed information about process data structure,

Diagnostic information and parameter addresses at <http://s.norgren.com/34d>

#### Parameter setting tools

You will find all necessary information about the required IO-Link hardware and software at <http://s.norgren.com/34d>

## 5. Installation

- I** Before installing and removing the unit: Make sure that no pressure is applied to the system.
  - ▶ Insert the unit in a G $\frac{1}{4}$  process connection.
  - ▶ Tighten firmly.
  
- II** Recommended tightening torque: 25 to 35 Nm

## 6. Electrical connection

**I** The unit must be connected by a qualified electrician. The national and international regulations for the installation of electrical equipment must be adhered to.

Voltage supply according to EN 50178, SELV, PELV.

- ▶ Disconnect power.
- ▶ Connect the unit as follows:

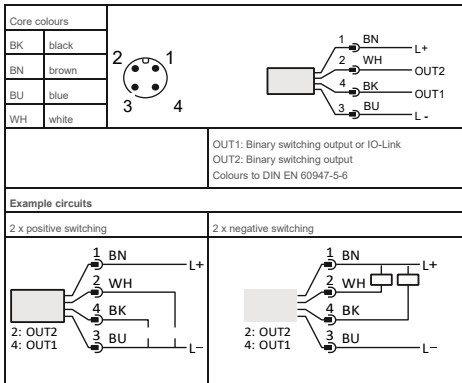



## 7. Operating and display elements

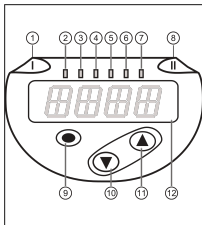

### 1 to 8: Indicator LEDs

LED 1	Switching status OUT1 (lights when output 1 is switched).
LED 8	Switching status OUT2 (lights when output 2 is switched).
LED 2 - 7	System pressure in the indicated unit of measurement.

### 9: [Enter] button [•]

- Selection of the parameters and acknowledgement of the parameter values.

### 10 to 11: Arrow keys up [▲] and down [▼]

- Setting of the parameter values (scrolling by holding pressed; incremental by pressing once).

### 12: Alphanumeric display, 4 digits

- Display of the current system pressure.
- Indication of the parameters and parameter values.

## 8. Menu

### 8.1 Menu structure: Main menu

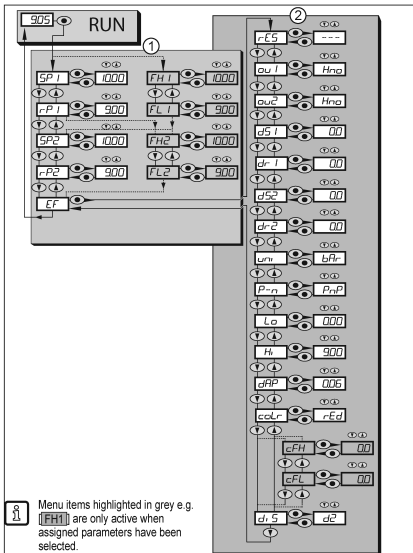

## 8.2 Explanation of the menu

### 8.2.1 Explanation of the menu level 1

<b>SPx/rPx</b>	Upper / lower limit value for system pressure at which OUT1 switches with hysteresis setting. SPx/rPx is displayed if the parameter [Hno] or [Hnc] for OUTx was set in the extended functions "EF" menu.
<b>FHx/FLx</b>	Upper / lower limit value for system pressure at which OUT1 switches with window setting. FHx/FLx is displayed if the parameter [Fno] or [Fnc] for OUTx was set in the extended functions "EF" menu.
<b>EF</b>	Extended functions / opening of menu level 2.

### 8.2.2 Explanation of the menu level 2

<b>rES</b>	Restore factory setting.
<b>ou1</b>	Output function for OUT1: <ul style="list-style-type: none"> <li>• Switching signal for the pressure limit values: hysteresis function [H ..] or window function [F ..], either normally open [. no] or normally closed [. nc].</li> </ul>
<b>ou2</b>	Output function for OUT2: <ul style="list-style-type: none"> <li>• Switching signal for the pressure limit values: hysteresis function [H ..] or window function [F ..] as normally open (. no) or normally closed (. nc) each.</li> </ul>
<b>dS1 / dS2</b>	Switching delays for OUT1 / OUT2.
<b>dr1 / dr2</b>	Switch-off delay for OUT1 / OUT2.
<b>uni</b>	Standard unit of measurement for system pressure (display): [bAr] / [mbar] / [MPa] / [kPa] / [PSI] / [inHG] .
<b>P-n</b>	Output logic: pnp / npn.
<b>Lo</b>	Minimum value memory for system pressure.
<b>Hi</b>	Maximum value memory for system pressure.
<b>dAP</b>	Damping of the measured signal.
<b>coLr</b>	Assignment of the display colours "red" and "green" within the measuring range.
<b>cFL / cFH</b>	Lower / upper value for colour change. Parameter only active after selection of a freely definable colour window in the coLr parameter: [r-cF] or [G-cF]
<b>diS</b>	Update rate and orientation of the display.



## 9. Parameter setting

During parameter setting the unit remains in the operating mode. It continues to monitor with the existing parameters until the parameter setting has been completed.

### 9.1 Parameter setting in general

1	<p><b>Select parameter</b></p> <ul style="list-style-type: none"> <li>▶ Press [●] to get to the menu.</li> <li>▶ [▲] ▶ [▼] Press [▲] or [▼] until the requested parameter is displayed.</li> </ul>	
2	<p><b>Set parameter value</b></p> <ul style="list-style-type: none"> <li>▶ Press [●] to edit the selected parameter.</li> <li>▶ [▲] Press [▲] ▼ or [▼] for min. 2 s.</li> <li>&gt; After 2 s: setting value is changed: incrementally by pressing the button once or continuously by keeping the button pressed.</li> </ul>	
Numerical values are incremented continuously with ▲[▲] or decremented with [▼].▼).		
3	<p><b>Acknowledge parameter value</b></p> <ul style="list-style-type: none"> <li>▶ Briefly press [●].</li> <li>&gt; The parameter is displayed again. The new setting value is saved.</li> </ul>	
<p><b>Set other parameters</b></p> <ul style="list-style-type: none"> <li>▶ Press [▲] or [▼] until the requested parameter is displayed.</li> </ul>		
<p><b>Finish parameter setting</b></p> <ul style="list-style-type: none"> <li>▶ Press [▲] or [▼] several times until the current measured value is displayed or wait for 30 s. &gt; The unit returns to the process value display.</li> </ul>		



Each parameter setting requires 3 steps:

- 1** If [C.Loc] is displayed when an attempt is made to modify a parameter value, an IO-Link communication is active (temporary locking).
- 2** If [S.Loc] is displayed, the sensor is permanently locked via software. This locking can only be removed using a parameter setting software.

**3** Change from menu level 1 to menu level 2:

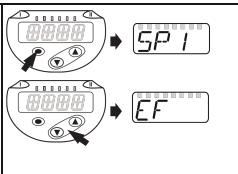
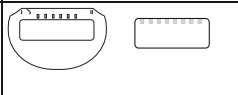
<ul style="list-style-type: none"><li>▶ Press [●] to get to the menu.</li><li>▶ Press [▼] or [▲] until [EF] is displayed.</li></ul>	
<ul style="list-style-type: none"><li>▶ Press [●].</li><li>&gt; The first parameter of the submenu is displayed (here: [rES]).</li></ul>	

- 1** Change from menu level 1 to menu level 2 when a parameter setting software is used:

- ▶ Activate the [EF] button.

🔒 **Locking / unlocking**

The unit can be locked electronically to prevent unintentional settings.

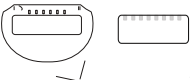
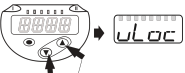
<p>▶ Make sure that the unit is in the normal operating mode.</p> <p>▶ Press [▲] + [▼] simultaneously for 10 s.</p> <p>&gt; [Loc] is displayed.</p>	 <p style="text-align: right;">10 s</p>
<p>During operation: [Loc] is briefly displayed if you try to change parameter values.</p>	
<p>For unlocking:</p> <p>▶ Press [▲] + [▼] simultaneously for 10 s.</p> <p>&gt; [uLoc] is displayed.</p>	 <p style="text-align: right;">10 s</p>



On delivery: not locked.

⌚ **Timeout:**

If no button is pressed for 30 s during parameter setting, the unit returns to the operating mode with unchanged values.



## 9.2 Configure display (optional)

<p>► Select [Uni] and set the unit of measurement: [bAr], [mbAr], [MPa], [kPa], [PSI], [inHG]</p> <p> The selectable units of measurement depend on the respective unit.</p>	
<p>► Select [diS] and set the update rate and orientation of the display: [d1]: update of the measured values every 50 ms. [d2]: update of the measured values every 200 ms. [d3]: update of the measured values every 600 ms. [rd1], [rd2], [rd3]: display as for d1, d2, d3; rotated by 180°. [OFF] = The measured value display is deactivated in the Run mode. The LEDs remain active even if the display is deactivated. Error messages are displayed even if the display is deactivated.</p>	
<p> Even with unsteady pressure characteristics [d1] provides optimum readability; the corresponding algorithms are stored.</p>	

## 9.3 Set output signals



### 9.3.1 Set output functions

<p>► Select [ou1] and set the switching function: [Hno] = hysteresis function/NO, [Hnc] = hysteresis function/NC, [Fno] = window function/NO, [Fnc] = window function/NC.</p>	
<p>► Select [OU2] and set the function: [Hno] = hysteresis function/NO, [Hnc] = hysteresis function/NC, [Fno] = window function/NO, [Fnc] = window function/NC.</p>	

**9.3.2 Define switching limits for the hysteresis function**

<ul style="list-style-type: none"> <li>▶ [ou1] / [ou2] must be set as [Hno] or [Hnc].</li> <li>▶ Select [SP1] / [SP2] and set the value at which the output is set.</li> </ul>	
<ul style="list-style-type: none"> <li>▶ Select [rP1] / [rP2] and set the value at which the output is reset.</li> </ul> <p>rPx is always smaller than SPx. The unit only accepts values which are lower than the value for SPx.</p>	

**9.3.3 Define switching limits for the window function**

<ul style="list-style-type: none"> <li>▶ [ou1] / [ou2] must be set as [Fno] or [Fnc].</li> <li>▶ Select [FH1] / [FH2] and set the upper limit value.</li> </ul>	
<ul style="list-style-type: none"> <li>▶ Select [FL1] / [FL2] and set the lower limit value.</li> </ul> <p>FLx is always lower than FHx. The unit only accepts values which are lower than the value for FHx.</p>	

**9.4 User settings (optional)****9.4.1 Set delay for the switching outputs**

<p>[dS1] / [dS2] = switching delay for OUT1 / OUT2. [dr1] / [dr2] = reset delay for OUT1 / OUT2.</p> <ul style="list-style-type: none"> <li>▶ Select [dS1], [dS2], [dr1] or [dr2] and set a value between 0 and 50 s (at 0 the delay time is not active).</li> </ul>	
<div style="border: 1px solid black; padding: 2px; display: inline-block; margin-bottom: 5px;">1</div> <p>For this unit the parameters [dSx] and [drx] for the set and reset points are designed strictly to the VDMA guideline.</p>	

**9.4.2 Set output logic for the switching outputs**

<ul style="list-style-type: none"> <li>▶ Select [P-n] and set [PnP] or [nPn].</li> </ul>	
--	--

**9.4.3 Set damping for the switching signal**

<ul style="list-style-type: none"> <li>▶ Select [dAP], set the value in seconds; setting range 0.000...4.000 s (T value: 63 %). At 0.00 [dAP] is not active.</li> </ul>	
---	--



**9.4.4 Read min-/max values for the system pressure**

- |  |  |
|--|--|
| <ul style="list-style-type: none"> <li>▶ Select [HI] or [Lo] and briefly press [●]. [HI] = maximum value, [LO] = minimum value. Delete memory:</li> <li>▶ Select [HI] or [LO].</li> <li>▶ Press and hold [▲] or [▼] until [----] is displayed. ▶ Briefly press [●].</li> </ul> |  |
|--|--|

**9.4.5 Reset all parameters to factory setting**

- |  |  |
|--|--|
| <ul style="list-style-type: none"> <li>▶ Select [rES].</li> <li>▶ Press [●].</li> <li>▶ Press and hold [▲] or [▼] until [----] is displayed. ▶ Briefly press [●].</li> </ul> <p>We recommend noting down your own settings before carrying out a reset (→ 12 Factory setting).</p> |  |
|--|--|

**9.4.6 Set colour change of the display**



- |  |  |
|--|--|
| <ul style="list-style-type: none"> <li>▶ Select [coLr] and set the function:           <ul style="list-style-type: none"> <li>- [rEd] = display colour red (independent of the measured value).</li> <li>- [GrEn] = display colour green (independent of the measured value).</li> <li>- [r1ou] = display colour red when OUT1 switches</li> <li>- [G1ou] = display colour green when OUT1 switches.</li> <li>- [r2ou] = display colour red when OUT2 switches.</li> <li>- [G2ou] = display colour green when OUT2 switches.</li> <li>- [r-12] = Display colour red when the measured value is between the limit values of OUT1 and OUT2.</li> <li>- [G-12] = Display colour green when the measured value is between the limit values of OUT1 and OUT2.</li> <li>- [r-cF] = Display colour red when the measured value is between the freely definable limit<sup>*)</sup> values [cFL]<sup>*)</sup> and [cFH]<sup>*)</sup>.</li> <li>- [G-cF] = Display colour green when the measured value is between the freely definable limit values [cFL]<sup>*)</sup> and [cFH]<sup>*)</sup>.</li> </ul> </li> </ul> <p><sup>*)</sup> <sup>*)</sup> The parameters [cFL] and [cFH] can only be selected in the menu tree when [r-cF] or [G-cF] were activated.</p> |  |
|--|--|

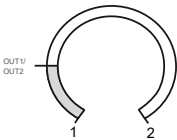
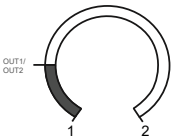

- |   |  |
|---|--|
| <ul style="list-style-type: none"> <li>▶ Select [cFL] and set the lower limit value (only possible when [r-cF] or [G-cF] were activated).</li> <li>&gt; The setting range corresponds to the measuring range and its maximum limit is [cFH].</li> </ul> |  |
|---|--|

- |  |  |
|--|--|
| <ul style="list-style-type: none"> <li>▶ Select [cFH] and set the upper limit value. (only possible when [r-cF] or [G-cF] were activated).</li> <li>&gt; The setting range corresponds to the measuring range and its minimum limit is [cFL].</li> </ul> |  |
|--|--|

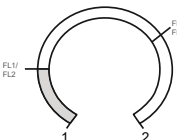
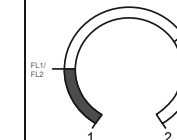
Display colour change for the parameters [r1ou] / [r2ou], mode hysteresis function	Display colour change for the parameters [G1ou] / [G2ou], mode hysteresis function
	
Measured value > switch point OUT1/OUT2; Display = red	Measured value > switch point OUT1/OUT2; Display = green

#### 9.4.7 Graphical illustration of the colour change of the display

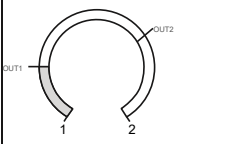
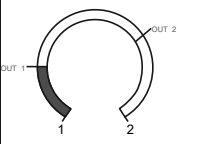
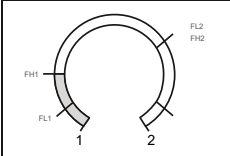
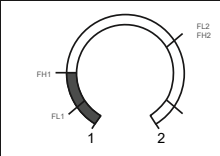
Display colour change for the parameters [r1ou] / [r2ou], mode window function	Display colour change for the parameters [G1ou] / [G2ou], mode window function.
	
Measured value between FL1/FL2 and FH1/FH2; Display = red	Measured value between FL1/FL2 and FH1/FH2; Display = green
	Colour change display green
	Colour change display red
1	Initial value of the measuring range
2	Final value of the measuring range

Display colour change for the parameters [r-12], mode <b>hysteresis function</b>		Display colour change for the parameters [G-12], mode <b>hysteresis function</b>	
			
Measured value between OUT1 and OUT2; Display = red		Measured value between OUT1 and OUT2; Display = green	
Display colour change for the parameters [r-12], mode <b>window function</b>		Display colour change for the parameters [G-12], mode <b>window function</b>	
			
Measured value outside FL1...FH1 and FL2...FH2; Display = red		Measured value outside FL1...FH1 and FL2...FH2; Display = green	
	Colour change display green		
	Colour change display red		
1	Initial value of the measuring range		
2	Final value of the measuring range		
FL1/FL2	Lower limit value window function outputs OUT1 / OUT2		
FH1/FH2	Upper limit value window function outputs OUT1 / OUT2		

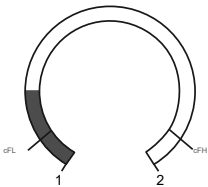
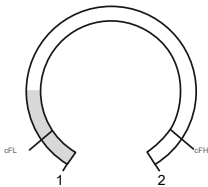
Display colour change with parameter [r-cF] independent of OUT1 / OUT2.	Display colour change with parameter [G-cF] independent of OUT1 / OUT2
	
Measured value between cFL and cFH; Display = red	Measured value between cFL and cFH; Display = green

## 10. Operation

After power on, the unit is in the Run mode (= normal operating mode). It carries out its measurement and evaluation functions and provides output signals according to the set parameters.

Operating indicators → 7 Operating and display elements.

### 10.1 Read set parameters

- ▶ Press [●].
- ▶ Press [▲] or [▼] until the requested parameter is displayed.
- ▶ Briefly press [●].
  - *The unit displays the corresponding parameter value for approx. 30 s; then it changes to the process value display.*

### 10.2 Self-diagnosis / error indications

The unit has many self-diagnostic options.

☞ *It monitors itself automatically during operation.*

☞ *Warnings and faults are displayed (even if the display is deactivated), in addition they are available via IO-Link.*

Display	Status-LED OUT1	Status-LED OUT1	Error type	Corrective measures
none			Supply voltage too low	▶ Check / correct the supply voltage
SC	flashes	flashes	Excessive current at switching outputs OUT1 + OUT2 *)	▶ Check switching outputs for short-circuit or excessive current; remove the fault.
SC1	flashes		Excessive current at switching output OUT1 *)	▶ Check switching output OUT1 for short-circuit or excessive current; remove the fault.
SC2		flashes	Excessive current at switching output OUT2*)	▶ Check switching output OU2 for short-circuit or excessive current; remove the fault.
CLoc			Parameter setting locked via pushbuttons, parameter setting is active via IO-Link communication (→ 9.1)	▶ Wait until parameter setting via IO-Link is finished.
SLoc			Setting buttons locked via parameter software. Parameter change is rejected (→ 9.1).	▶ Unlocking only possible via IO-Link interface / parameter software.
OL			Process value too high. (measuring range exceeded)	▶ Check / reduce system pressure / select unit with corresponding measuring range.
UL			Process value too low (value below measuring range)	▶ Check / increase system pressure / select unit with corresponding measuring range. Measuring range

\*) The respective output remains deactivated as long as the excessive current / short circuit continues.

## 11. Technical data

### 11.1 Setting ranges

		SP1 / SP2		rP1 / rP2		ΔP
		min	max	min	max	
34D-P600...	bar	4	600	2	598	2
	PSI	40	8700	20	8680	20
	MPa	0,4	60	0,20	59,8	0,20
34D-P400...	bar	4	400	2	398	2
	PSI	40	5800	20	5780	20
	MPa	0,4	40	0,20	39,8	0,20
34D-P250...	bar	2	250	1	249	1
	PSI	40	3620	20	3600	20
	MPa	0,20	25	0,1	24,9	0,1
34D-P160...	bar	1	160	0,5	159,5	0,5
	PSI	14,5	2320	5	2313	7,25
	MPa	0,1	16	0,05	15,9	0,05
34D-P100...	bar	1	100	0,5	99,5	0,5
	PSI	14,5	1450	7,25	1442,75	5
	MPa	0,1	10	0,05	9,95	0,05
34D-P040...	bar	1	40	0,5	39,5	0,5
	PSI	14,5	580	7,25	572,75	7,25
	MPa	0,1	4	0,05	3,95	0,05
34D-P016...	bar	1	16	0,5	15,5	0,5
	PSI	14,5	232	7,25	224,75	7,25
	kPa	0,1	1,6	0,05	1,55	0,05
34D-V110...	bar	-0,9	10	-0,95	9,95	0,05
	PSI	-13,5	145	-14	144,5	0,5
	MPa	-0,09	1	0,095	0,995	0,005
34D-V101...	mbar	-980	1000	-990	990	10
	PSI	-14,3	14,5	-14,4	14,4	0,1
	kPa	-98	100	-99	99	1
	inHG	-29	29,6	-29,2	29,4	0,20

ΔP = step increment

### 11.2 Further technical data

 Further technical data and dimensions at [www.imi-precision.com](http://www.imi-precision.com)

## 12 Factory setting

	Factory setting	User setting / Comments
SP1	25% MEW*	
rP1	23% MEW*	
OU1	Hno	
OU2	Hno	
SP2	75% MEW*	
rP2	73% MEW*	
dS1	0,0	
dr1	0,0	
dS2	0,0	
dr2	0,0	
P-n	PnP	
dAP	0,06	
Uni	bAr / mbAr	
colr	rEd	
diS	d2	

\* = The indicated percentage of the final value of the measuring range (VMR) of the respective sensor is set.



The data specified above only serve to describe the product.

No statements concerning a certain condition or suitability for a certain application can be derived from our information.

The given information does not release the user from the obligation of own judgement and verification.

It must be remembered that our products are subject to a natural process of wear and aging.

© This document, as well as the data, specifications and other informations set forth in it, are the exclusive property of Norgren GmbH.

Without their consent it may not be reproduced or given to third parties.

Subject to modifications.

Printed in Germany.

These instructions were originally generated in German.

Order no. **750375500000050**