

# Valve Islands

## Flexible and Modular for all Industrial Automation Applications

*Highly flexible and versatile*

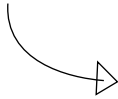

*Easy to configure online at [www.norgren.com](http://www.norgren.com)*



*Connected*



# CONTENTS

<b>Introduction</b>	<b>02</b>
<b>Norgren Valve Island Portfolio</b>	<b>03</b>
<b>VR Series Valve Islands</b>	<b>04</b>
<b>VS Series Valve Islands</b>	<b>06</b>
<b>VM Series Valve Islands</b>	<b>10</b>
<b>Valve Islands with Industrial Ethernet</b>	<b>12</b>
<b>Valve Islands with IO-Link</b>	<b>13</b>
<b>Accessories</b>	<b>14</b>
<b>Valve Island Configurator</b>	<b>15</b>

## Breakthrough Engineering for a Better World

**Norgren is part of global engineering organisation IMI plc. IMI is at the forefront of delivering the solutions we need in a changing world and is focused on **creating tremendous value by solving key industry problems** in attractive markets and employing the best.**

Norgren has a proud history of creating innovative engineering solutions in precise motion control and fluid technology, and we collaborate with our customers across more than 50 countries in critical areas such as Factory Automation, Material Handling, Rail, Energy, Process Control, Life Science and Commercial Vehicles.

From improving speed, productivity, reliability and efficiency of equipment, to generating significant energy and cost savings, or lowering total cost of ownership across many industries, Norgren's high-quality solutions are designed to help customers pursue progress, achieve new goals and overcome problems.

With market-leading industry expertise, we offer the capability, resources, engineering intelligence and global support infrastructure to tackle the largest project demands.

Our world-class portfolio of fluid and motion control products include Norgren, Bimba, Buschjost, FAS, Herion, Kloehn and Maxseal. Supplied either individually or combined into powerful customised solutions to meet customer needs.

**Breakthrough engineering you can count on.**

# Norgren Valve Island Portfolio

Valve Islands, also known as valve manifolds, system valves or plug in type manifolds, are commonly used on machine installations to reduce assembly and downtime and provide easier fault diagnosis.

Valve islands are a collection of valves mounted into one unit, reducing pipework, electrical connections and complexity. We have been offering valve islands for over twenty years, and all our valve island ranges are configured individually to suit your needs and application.

	<p><b>VM10</b> 430 l/min 8 - 16 Valves</p>	<p><b>VR10</b> 270 l/min 2 - 24 Valves</p>	<p><b>VR15</b> 590 l/min 2 - 24 Valves</p>	<p><b>VS18</b> 650 l/min 4 - 20 Valves</p>	<p><b>VS26</b> 1350 l/min 4 - 20 Valves</p>	
 	<p><b>VM10</b> 430 l/min 8 - 16 Valves</p>	<p><b>VR10</b> 270 l/min 2 - 24 Valves</p>	<p><b>VR15</b> 590 l/min 2 - 24 Valves</p>	<p><b>VS18</b> 650 l/min 4 - 16 Valves</p>	<p><b>VS26</b> 1350 l/min 4 - 16 Valves</p>	
  	<p><b>VM10</b> 430 l/min 8 - 16 Valves</p>	<p><b>VR10</b> 270 l/min 2 - 24 Valves</p>	<p><b>VR15</b> 590 l/min 2 - 24 Valves</p>	<p><b>VS18</b> 650 l/min 2 - 20 Valves</p>	<p><b>VS26</b> 1350 l/min 2 - 20 Valves</p>	
	<p><b>VM10</b> 430 l/min 4 - 16 Valves</p>	<p><b>VM15</b> 1000 l/min 4 - 16 Valves</p>	<p><b>VR10</b> 270 l/min 2 - 24 Valves</p>	<p><b>VR15</b> 590 l/min 2 - 24 Valves</p>	<p><b>VS18</b> 650 l/min 2 - 20 Valves</p>	<p><b>VS26</b> 1350 l/min 2 - 20 Valves</p>
<p><b>Multipole</b></p>	<p><b>VM10</b> 430 l/min 4 - 20 Valves</p>	<p><b>VM15</b> 1000 l/min 4 - 20 Valves</p>	<p><b>VS18</b> 650 l/min Mini ISO V40/41</p>	<p><b>VS26</b> 1350 l/min Mini ISO V44/45</p>		
<p><b>Single Wiring</b></p>						



# VR Series Valve Islands



Flexibility and modularity have reached new levels with the **Norgren VR Valve Island** range. A simple plug-in, sub-base style design allows for valves to be easily exchanged for easy installation and maintenance. Expanding the size and functionality of your Valve Island to match the changing demands of your application is a simple "plug-and-play" experience.

Available in two body sizes – 10mm and 15mm, the VR10/15 series can be used across a broad range of Industrial Automation markets, from food & beverage, packaging, labelling, textiles, glass production, metal production and paper and print.

## Product Highlights:

- » **Modular** – A modular system offering a wide range of configuration options
- » **Flexible** – Available in 10mm and 15mm with up to 24 solenoids with a wide range of valve functions
- » **Reliable** – Using proven technology for long life over 30 million cycles
- » **Connected** – Fast and easy connectivity via Multipole, EtherNet/IP, PROFINET, EtherCAT and IO-Link
- » **Easy Installation** – No restrictions in installation as connectors can be horizontal or vertical. Valve island can be direct mounted or mounted on a DIN rail.
- » **Maintenance Friendly** – Simple plug-in sub base valve exchange allows easy exchange of system components and interruption-free valve replacement option; and integrated silencers offer simple replacement
- » **Energy Saving** – Low power solenoids (0.4w power consumption) with LED indicators
- » **Space Saving** – If space is an issue, the IP40 base is available with valve slices
- » **Easy to Configure** – BEST IN CLASS online configurator

# Technical Specifications

## VR Series, 2 x 3/2, 5/2 or 5/3 Valve Island

- » Two sizes, 10 mm and 15 mm widths
- » Flow: 220 to 270 l/min (VR10), 460 to 590 l/min (VR15)
- » Operating pressure: Maximum pressure 7 bar (101 psi)
- » Operating temperature: -5°C to +50°C (+23°F to 122°F)
- » Up to 24 solenoids
- » 24V DC & 12V DC Multipole, EtherNet/IP, PROFINET, EtherCAT and IO-Link
- » Dynamic Softseal spool valve, solenoid pilot operated
- » LED indicator of solenoid function
- » No restriction in installation orientation
- » Easy to replace valves, fittings and silencers
- » Robust yet lightweight construction
- » IP40 and IP65 versions available

10 mm and 15 mm widths with up to 24 solenoids

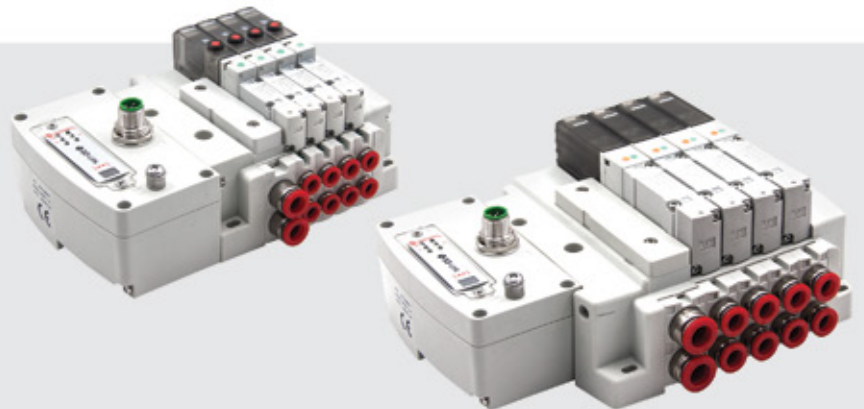

Modular System



Interruption-free valve replacement

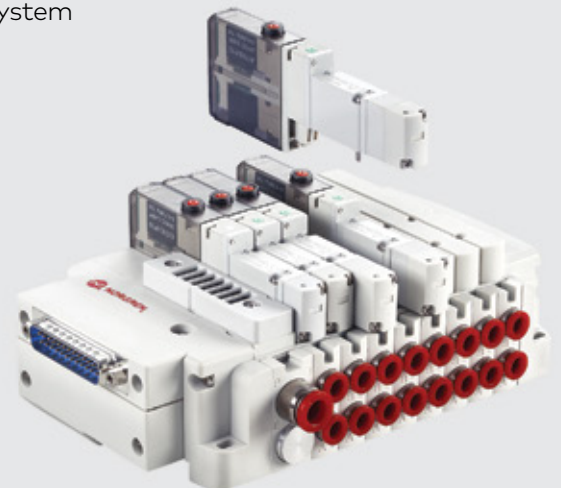

Multipole, Industrial Ethernet and IO-Link connectivity

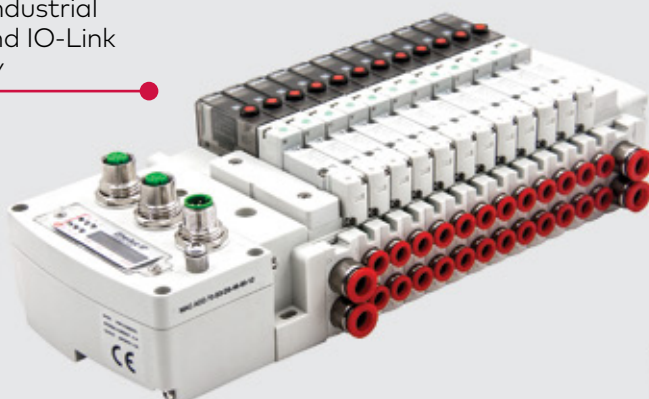

IP65 Multipole

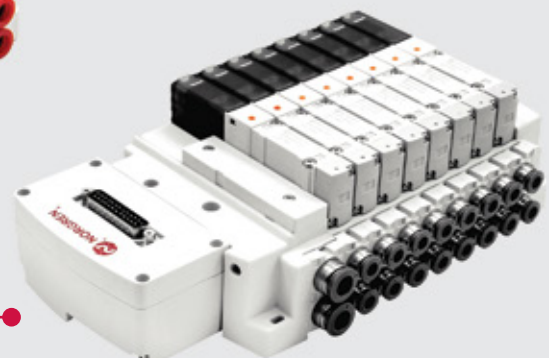

# VS Series Valve Islands



The VS Series gives you the versatility to choose the features you need with the modularity to easily expand and add accessories. By combining flexibility and Swiss-engineered quality, we have created a no-compromise valve range with unlimited ability. Whether using a simple Multipole, complex Fieldbus, PROFINET, EtherNet/IP, or IO-Link system expanding the size of your valve island to match the changing demands of your equipment is a simple "plug-and-play" experience. Our plug-in Printed Circuit Board (PCB) technology takes only seconds to install and additional sub-bases can be attached with only two screws.

The VS18 and VS26 valve islands are unique in offering two spool technologies. To maximize the speed of your pneumatic system, use the Norgren softseal spool to achieve enhanced flow rates. For extended life, our glandless spool and sleeve delivers hundreds of millions of troublefree cycles. Or incorporate both spool technologies within the same valve island to optimize your machine's performance.

- 1 Add up to 4 stations easily**  
No need to disassemble the valve island (no tie rods)
- 2 Simple installation**  
Plug-in sub-base valve
- 3 Correct connection guaranteed**  
Simple plug-in electronics
- 4 Only seconds to install**  
Only 2 screws for additional sub-base attachment
- 5 Integrated fittings (VS18/VS26)**  
Reduce installation time, minimize leak paths
- 6 Total reliability**  
Glandless spool and sleeve deliver millions of trouble-free cycles
- 7 Maximum speed**  
Soft seal spool for enhanced flow rates
- 8 Connected**  
Fast and easy connectivity via Multipole, Fieldbus, EtherNet/IP, PROFINET and IO-Link

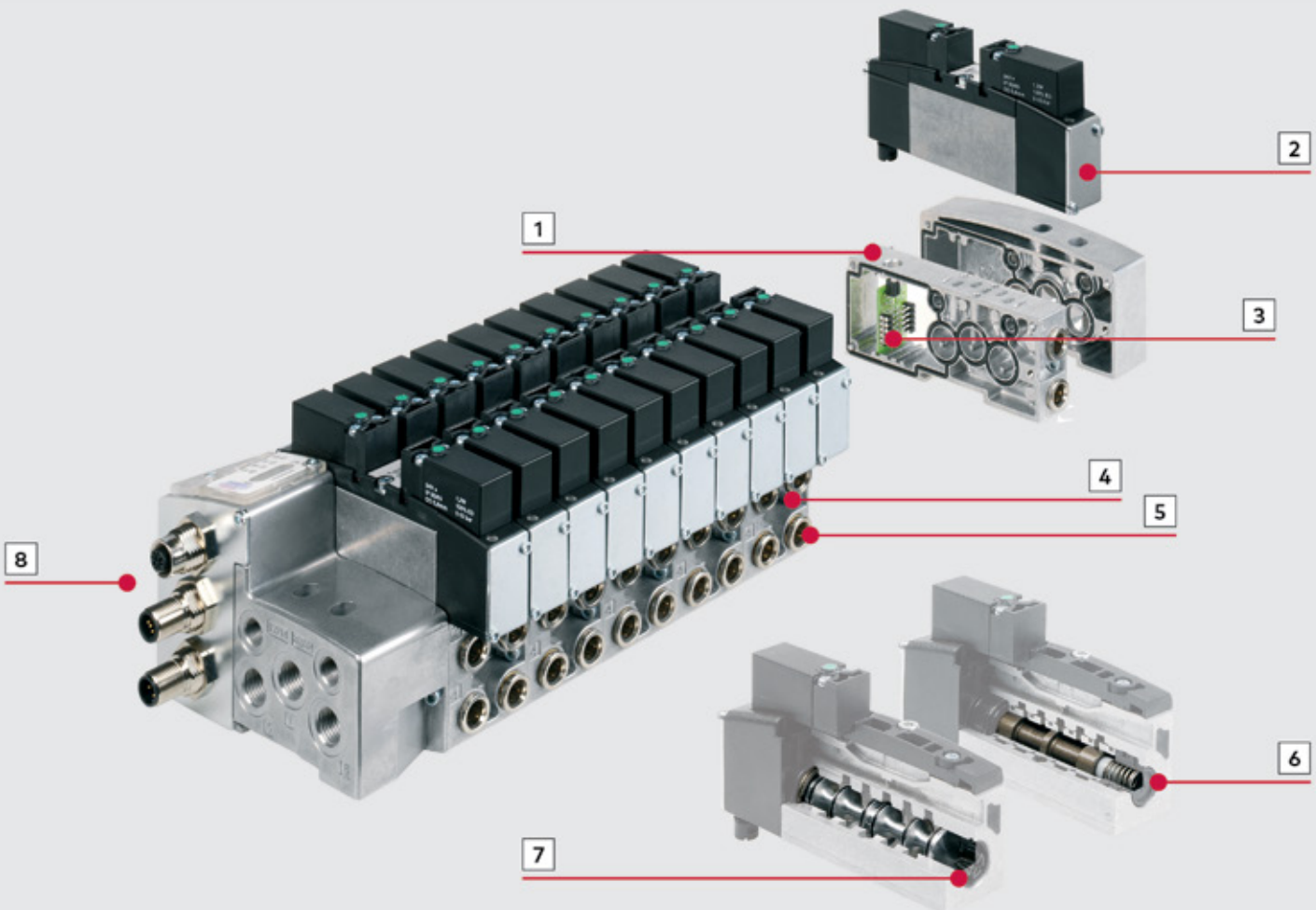

## Innovation

- » 2 patents
- » Universal PNP/NPN 24V DC Multipole connection
- » One Piece Solid PCB valve connection system, eliminating potential bad connections
- » Extensive multi-pressure options, allows pressure/vacuum zoning within the same valve island

## Modular

- » Fieldbus and Multipole extendable in single stations
- » Industrial Ethernet and IO-Link extendable in double stations
- » Up to 40 solenoid valves depending on Fieldbus, Industrial Ethernet, IO-Link or Multipole
- » Extensive sandwich accessory options
- » Two sizes of plug-in sub-base valves
- » Flow from 550 to 1350 l/min.

## Versatile

- » Two spool technologies with unique advantages
- » Universal PNP/NPN 24V DC Multipole
- » Eleven valve configurations
- » Two Multipole voltages
- » Three integrated Fieldbus protocols
- » Two Industrial Ethernet protocols and IO-Link available
- » Numerous porting and manual override options
- » Millions of possibilities

## Reliable

- » 200 million cycles valve life (glandless spool and sleeve)
- » Robust construction
- » IP 65 and NEMA 4
- » Durable electrical technology
- » ATEX approved

## Maintenance friendly

- » Simple plug-in sub-base valve exchange
- » Interruption-free valve replacement option
- » Easy exchange of system components

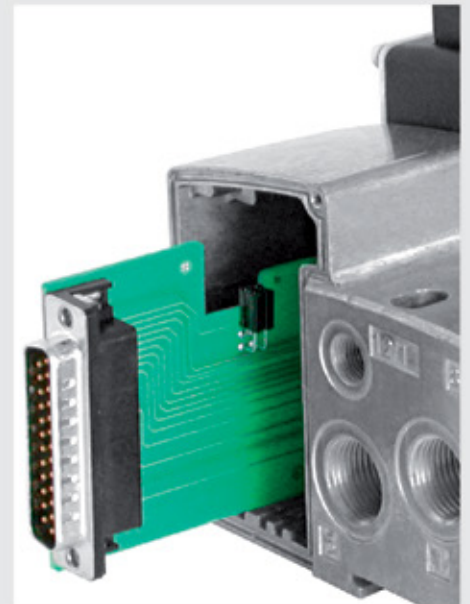
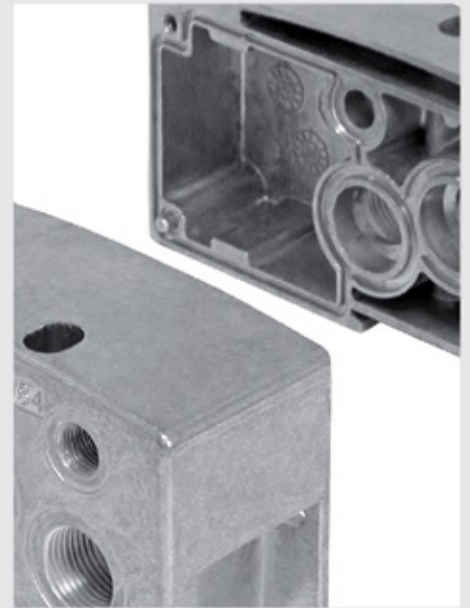



## Plug-in technology

### Pneumatics

- » Two sizes, 18 mm and 26 mm width
- » Up to 20 stations (40 solenoids) depending on protocol
- » VS18 and VS26 comply with ISO 15407-2 standard
- » Simple multi-pressure functionality
- » 2 x 3/2 valves in one body
- » 2 x 2/2 valves in one body (VS18/VS26)

### Multipole

- » 24V DC and 115V AC voltage options
- » Wide range of electrical connections
- » Field expandable up to four additional stations
- » One universal 24V DC PCB for both PNP/NPN

### Fieldbus

- » Compact size through integrated electronics
- » Field expandable up to four additional stations
- » Wide range of protocols offered

### Industrial Ethernet

- » Ultimate flexibility in machine design
- » Standardised platform for networking of devices
- » Real-time data transmitted simultaneously over a common medium
- » Large network coverage and almost unlimited number of users
- » Large amounts of data transferable
- » Equal bus access authorisation
- » Quick and easy commissioning

## VS Series gives you options

### Glandless or softseal spool valves – the right technology, for every application

For a higher flow rate use the Norgren softseal spool.

For maximum reliability choose our glandless spool technology.

Or simply use both to optimize your machine performance.

Size	Spool type	Flow l/min	Max. op. Pressure	Spool technology rating
VS18	Glandless	550 l/min	16 bar	200 million cycles
VS18	Softseal	650 l/min	10 bar	50 million cycles
VS26	Glandless	1000 l/min	16 bar	200 million cycles
VS26	Softseal	1350 l/min	10 bar	50 million cycles



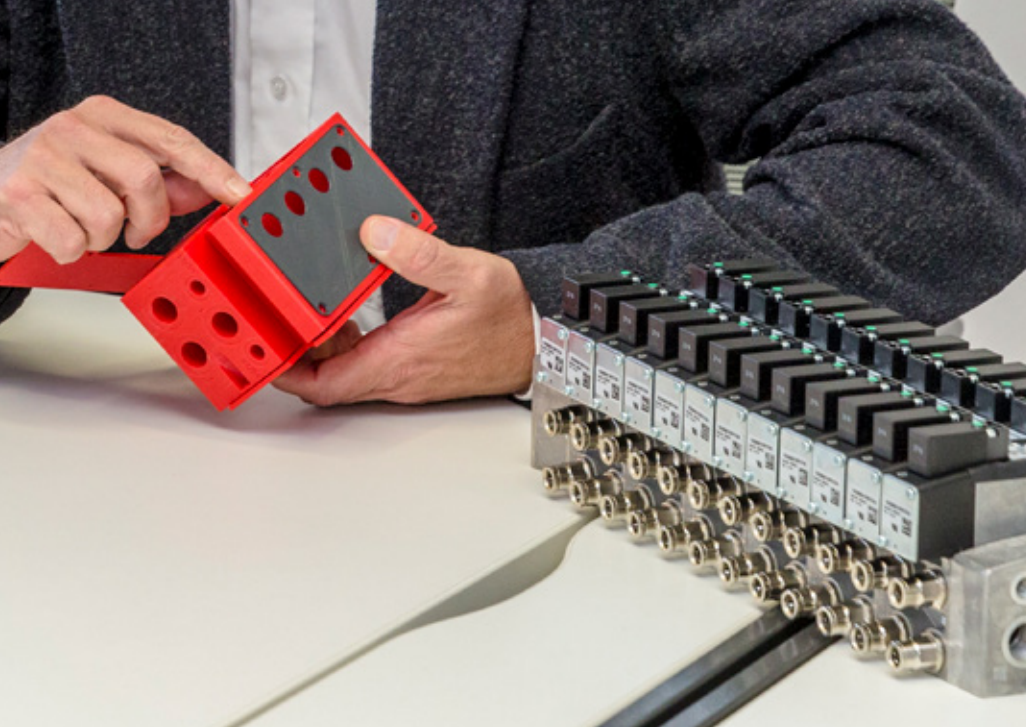

## VS Series Quick Guide

### VS18

<b>Product specification</b>	Flow	550 to 650 l/min
	Ports 2&4	G1/8, 6 mm or 8 mm PIF NPTF 1/8 Plug-in 1/4, 6 mm and 8 mm
	Fieldbus	4 to 16 stations
	Industrial Ethernet	4 to 20 stations
	Multipole	2 to 20 stations
	IO-Link	2 to 20 stations
	Voltage	24V DC or 115V AC* (*Multipole only)

### VS26

<b>Product specification</b>	Flow	1000 to 1350 l/min
	Ports 2&4	G1/4, 8 mm or 10 mm PIF 3/8 PIF, NPTF 1/8
	Fieldbus	4 to 16 stations
	Industrial Ethernet	4 to 20 stations
	Multipole	2 to 20 stations
	IO-Link	2 to 20 stations
	Voltage	24V DC or 115V AC* (*Multipole only)

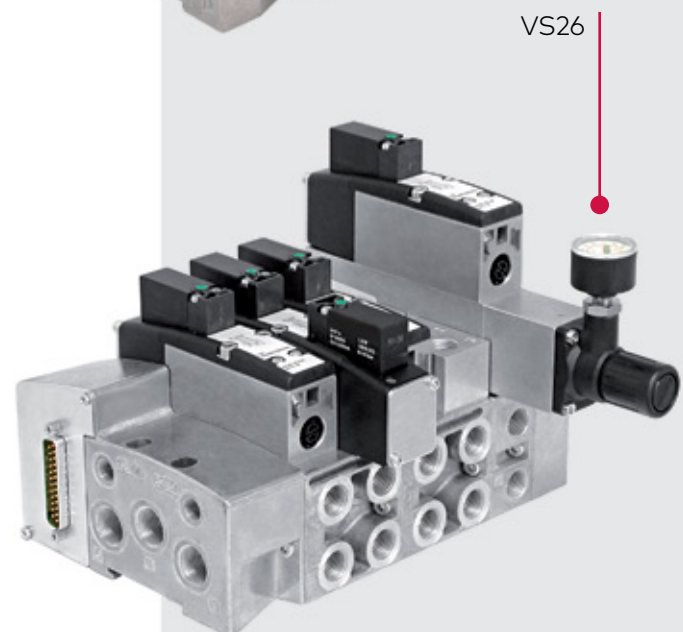
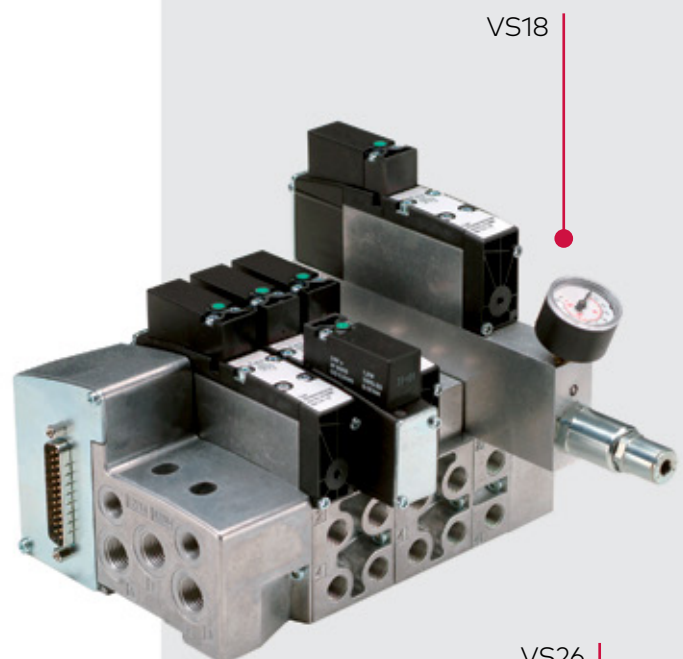

# VM Series Valve Islands



**The VM Series Valve islands are available in both 10 mm and 15 mm valve body widths and provide unsurpassed flow rates of 430 l/min and 1,000 l/min respectively. VM10/15 offer one of the best footprint to flow ratios in the market.**

**Offering fast and easy connectivity via Individually wired, Multipole, Fieldbus\*, PROFINET\* or EtherNet/IP\*.**

You can also choose from DIN rail, through hole, panel and sub base mounting options. Valve islands can be configured from 2 to 20 stations (Individually Wired option above 16 stations only) with single or double solenoids and with a high number of possibilities for manual overrides and tube fitting sizes. This results in over 15 million possible configurations. Selection, however, is simple. We provide an online configuration tool which provides you with a part number and price, and you can download your configuration in your native CAD format.

## VM10

A 10 mm valve body width system valve with an unsurpassed flow rate of 430 l/min. Its design ensures it is highly suitable for many applications across a wide range of industry sectors. The high number of options available enables configuration of the valve islands to meet your exact requirements.

- » Ultimate flexibility in machine design
- » Standardised platform for networking of devices
- » Real-time data transmitted simultaneously over a common medium
- » Large network coverage and almost unlimited number of users
- » Large amounts of data transferable
- » Equal bus access authorisation
- » Fast and easy connectivity via Individually wired, Multipole, Fieldbus, PROFINET or EtherNet/IP
- » Available in 8, 10, 12 and 16 stations having up to 32 solenoids

## VM15

A 15 mm valve body width system valve, again providing unsurpassed flow for size, this time 1,000 l/min. It has some of the options offered with the VM10 plus some additional multipressure options often required with higher flow applications.

Configuring valve islands to exactly match requirements is easy using our simple software configuration tool available on-line.

\* Fieldbus and Industrial Ethernet options only available on VM10.

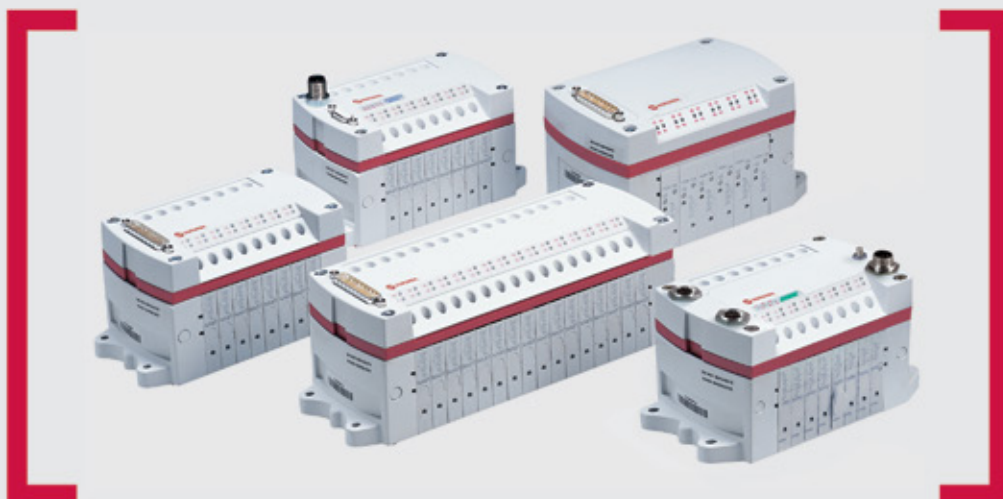

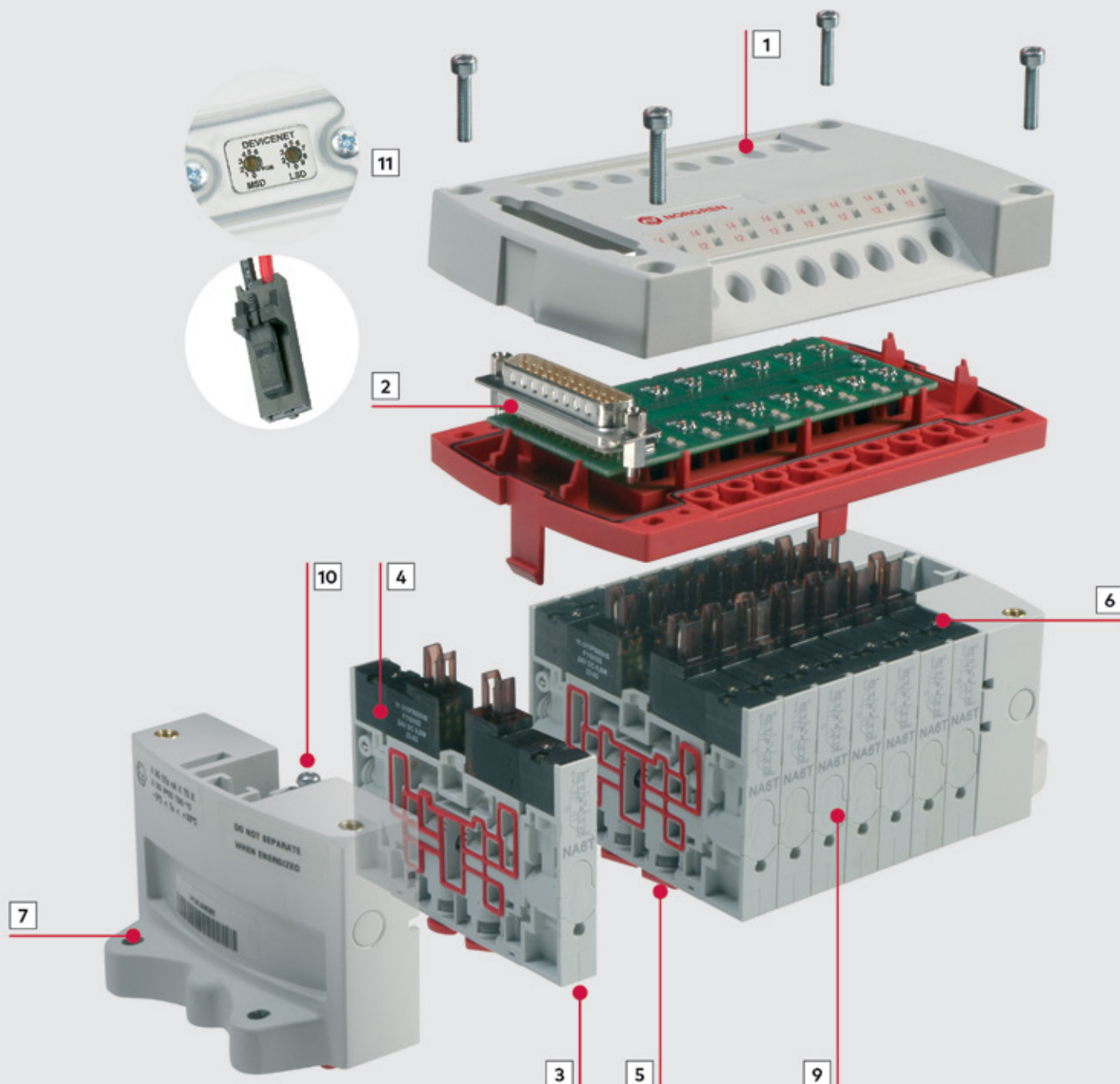

- 1** Engineered polymer provides increased strength and weight reduction
- 2** Individually wired and Multipole options provide connection flexibility
- 3** 430 l/min from a 10 mm valve body width 1,000 l/min from a 15 mm valve body width provides maximum flow to size ratio
- 4** 32 solenoids possible with Multipole, Fieldbus\*, PROFINET\* or EtherNet/IP\* enabling a reduction in the number of valve islands required
- 5** Integral push in fittings reduce component count, reduce valve island size and eliminate potential leak paths
- 6** Manual override options provide the ability to choose the variant best suited to the application
- 7** Through hole mounting enables valve islands to be directly mounted without the need for additional brackets
- 8** The VM range has CE and UL approval (not including Industrial Ethernet) and is approvals and is also LABS free ensuring the product complies with the required international standards reduction
- 9** Laser etched part numbers ensure easy identification of components
- 10** Single screw and hinge locking mechanism for securing each valve to the next facilitates simple valve addition and exchange (no tie rods)
- 11** Rotary switches for simple setting and identification of Fieldbus node addresses
  - » Balanced spool design enables the valves to be used with both pressure and vacuum
  - » Proven spool and seal pack design ensures a high life of 100,000,000 cycles

# Valve Islands with Industrial Ethernet

- » Ultimate flexibility in machine design
- » Standardised platform for networking of devices
- » Real-time data transmitted simultaneously over a common medium
- » Large network coverage and unlimited number of users
- » Large amounts of data transferable
- » Equal bus access authorisation

## INTERNET

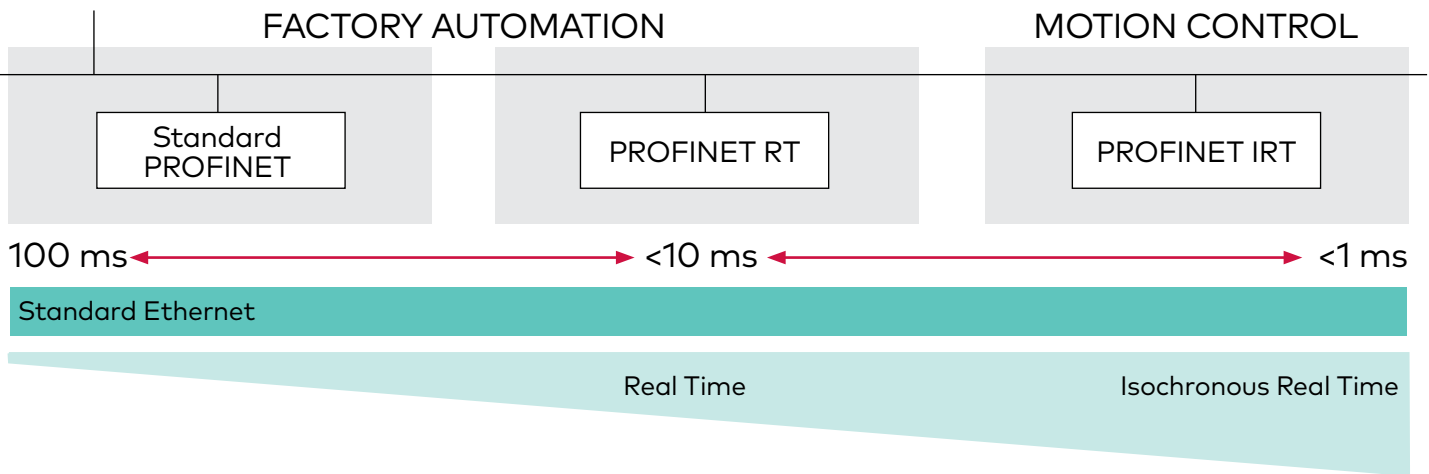

## Benefits of PROFINET IRT

- » PROFINET IRT offered as standard
- » Isochronous Real Time - The highest level of PROFINET available
- » The latest and most advanced Industrial Ethernet Protocol
- » For use in fast motion control applications that need precise and deterministic data exchange
- » Ideal for applications where motion control is critical to production cycles in the most demanding control environments
- » Over 100 times faster than standard Ethernet - Ultra short cycle times, independent of the network load

## Benefits of EtherNet/IP

- » More flexible network connectivity with a robust industrial standard
- » Various topology options available
- » Users are provided with standard Ethernet topology for industrial automation applications
- » Based on standard Internet and Ethernet



# Valve Islands with IO-Link

- » Open standard serial communication protocol
- » Standardised worldwide IO technology
- » Communication specification IEC61131-9
- » Connects intelligent sensors, field-devices and actuators
- » Manufacturer independent "point-to-point" connection
- » Uses advantages of available IO interfaces

## Benefits of IO-Link

- » **Standardised and Reduced Wiring** – IO-Link does not require any special or complicated wiring
- » **Increased Data Availability** – Access to sensor-level data helps ensure the smooth operation of system components
- » **Remote Configuration and Monitoring** – Users can read and change device parameters through the control system software, enabling fast configuration and commissioning
- » **Simple Device Replacement** – IO-Link's data storage capability allows for automated parameter reassignment in case of device replacement
- » **Extended Diagnostics** – IO-Link provides users with visibility into errors and health status from each device

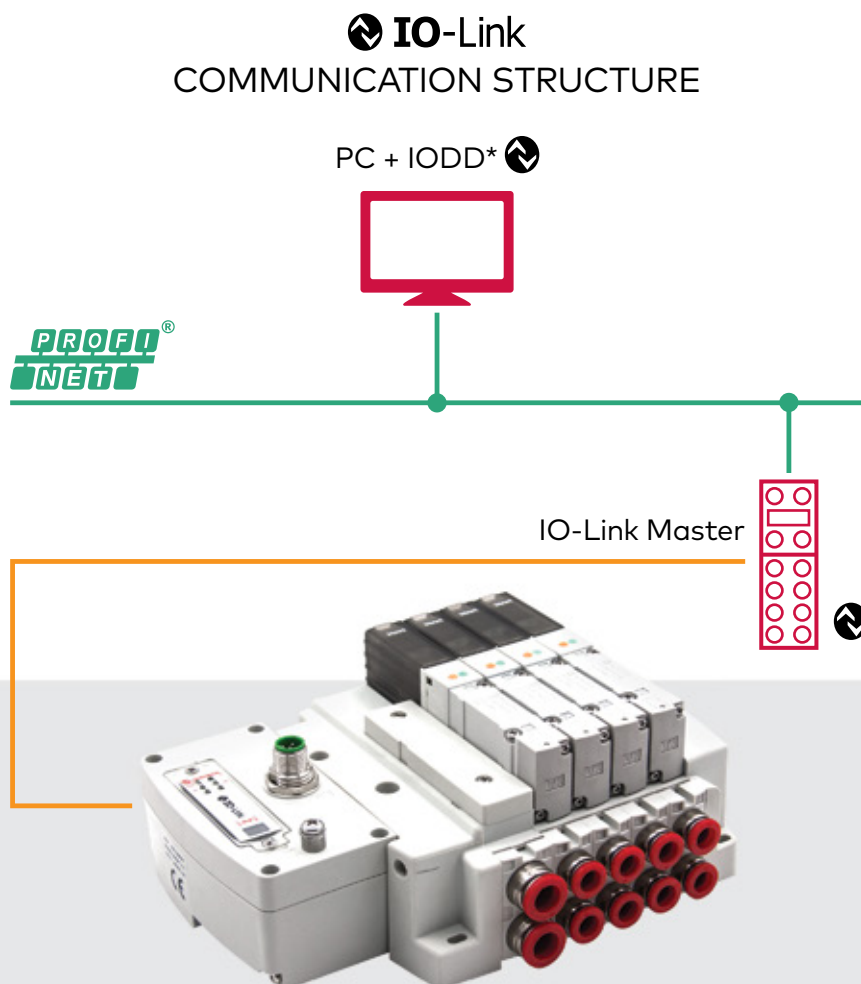

\* IODD = IO Device Description

# Accessories

We offer a number of accessories and spare elements for our valve island ranges.

VS

**Pressure control**

Four choices of pressure regulator sandwich plates provide individual pressure and force control as well as optimized air consumption.

**Multi-pressure control**

Intermediate supply & exhaust manifold and blanking discs enable simple and sophisticated multi-pressure designs.

**Flow control**

Flow control sandwich plate provides actuator speed control.



**Single station sub-base**

For applications requiring single valves located remotely from the valve island.

**Inlet air control (VS18/VS26)**

Single valve shut-off plate allows exchange of valve while valve island is pressurised.

VM

ISEMs (Intermediate Supply Exhaust Module) enable multiple pressures to be controlled in one valve island

Robust bracket for mounting directly or via DIN rail



Clip in manual overrides for VM10 for operating solenoid overrides without the need for tools

Stick on label and hinged label housing provide flexibility in valve identification

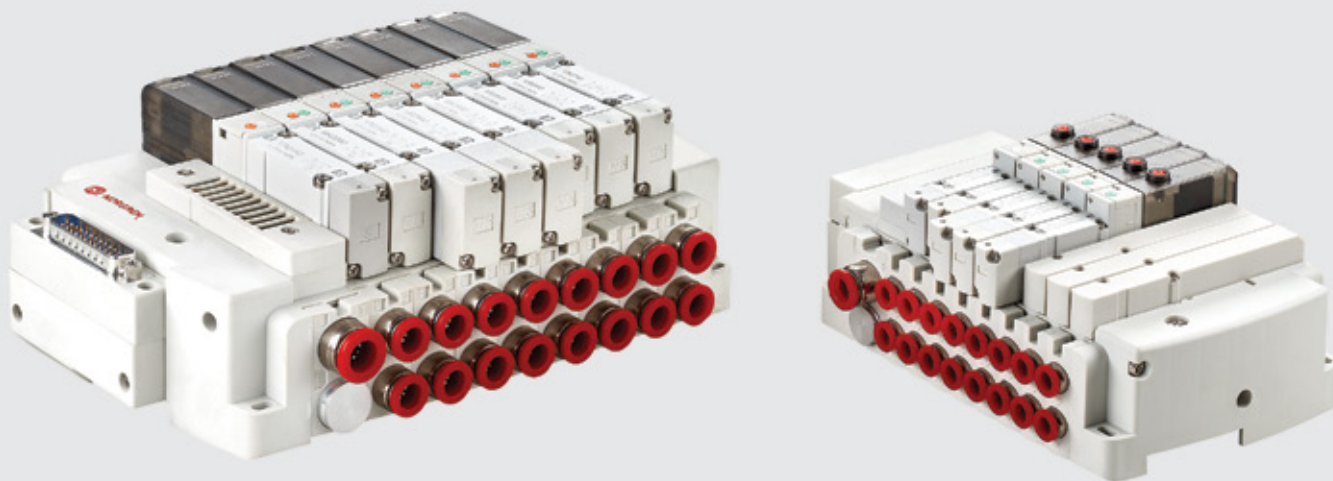

# Valve Island Configurator

- » Intuitive, flexible and easy to use
- » Flexible Step by step process that is easy navigate for any user regardless of experience
- » Enables quick specification of the valve island to meet your exact requirements
- » Provides price, availability and order now options
- » Unique part number assigned to your manifold
- » Live visualisation of your configuration and downloadable 2D and 3D CAD files
- » Download your configuration in your native CAD format. We support 60+ native CAD formats including AutoCAD, SolidWorks, Pro/Engineer, NX and Catia
- » Easy to access and download all technical documentation and available in multiple languages
- » Save your configurations for a later date and view your history anytime
- » Online and telephone support available

[www.norgren.com](http://www.norgren.com)



Norgren operates four global centres of technical excellence and a sales and service network in 50 countries, as well as manufacturing capability in Brazil, China, Czech Republic, Germany, India, Mexico UK and the USA.

For information on all Norgren companies visit

[www.norgren.com](http://www.norgren.com)

**Supported by distributors worldwide.**

For further information, scan this QR code or visit [www.norgren.com](http://www.norgren.com)



Norgren, Bimba, Buschjost, FAS, Herion, Kloehn and Maxseal are registered trademarks of Norgren companies.

Due to our policy of continuous development, Norgren reserve the right to change specifications without prior notice.

z9580BR en/05/21

Selected Images used under license from Shutterstock.com

Incorporating



IMI